



2024

INDOOR

live your light

Ray Spot



Track Spot

RAY SPOT/TRACK SPOTLIGHT

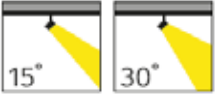

ÜRÜN ÖZELLİKLERİ/PRODUCT SPECIFICATIONS

Ürün Tanımı	Magnet Ray Spot	Product Description	Magnet Track Spot
Gövde	Metal Gövde	Body	Metal Body
Boya	Elektrostatik Toz Boya	Paint	Elektrostatic Powder Coated
PCB		PCB	
Lens		Lens	
Reflektör	Yüksek Safılıkta Alüminyum	Reflector	High Purity Aluminum
Difüzör		Diffuser	
SDCM (MacAdam)	3	SDCM (MacAdam)	3
Renk Sıcaklığı	3000K	Colour Temperature	3000K
Ömür	50000h	Life Time	50000h
Çalışma Sıcaklığı	25°C	Operating Temperature	25°C
LED	Osram/Samsung	LED	Osram/Samsung
Sürücü		Driver	
Uygunluk	EN 60598-1 EN 60598-2-2	Conformity	EN 60598-1 EN 60598-2-2

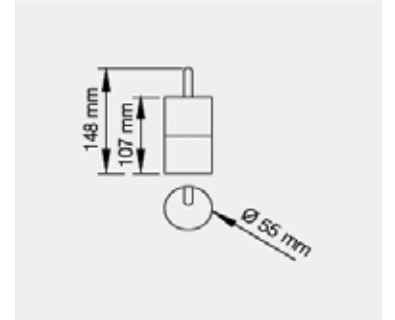

Ürün Kodu Product Code	Güç Power	Çıkış Işık Akısı Lumen Output	Verimlilik Efficiency	Işık Açısı Beam Angle	Işık Kaynağı Light Source	CRI	L (mm)	W (mm)	H (mm)
28147	8W	587Lm	73Lm/W	15°/30°	LED	80			



RAY SPOT/TRACK SPOTLIGHT



ÜRÜN ÖZELLİKLERİ/PRODUCT SPECIFICATIONS

Ürün Tanımı	Magnet Ray Spot	Product Description	Magnet Track Spot
Gövde	Metal Gövde	Body	Metal Body
Boya	Elektrostatik Toz Boya	Paint	Elektrostatic Powder Coated
PCB		PCB	
Lens		Lens	
Reflektör	Yüksek Safılıkta Alüminyum	Reflector	High Purity Aluminum
Difüzör		Diffuser	
SDCM (MacAdam)	3	SDCM (MacAdam)	3
Renk Sıcaklığı	3000K	Colour Temperature	3000K
Ömür	50000h	Life Time	50000h
Çalışma Sıcaklığı	25°C	Operating Temperature	25°C
LED	Osram/Samsung	LED	Osram/Samsung
Sürücü		Driver	
Uygunluk	EN 60598-1 EN 60598-2-2	Conformity	EN 60598-1 EN 60598-2-2

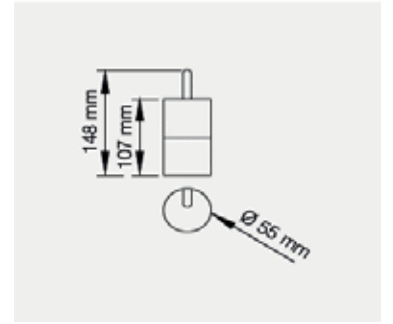

Ürün Kodu Product Code	Güç Power	Çıkış Işık Akısı Lumen Output	Verimlilik Efficiency	Işık Açısı Beam Angle	Işık Kaynağı Light Source	CRI	L (mm)	W (mm)	H (mm)
28148	3,4W	326Lm	95Lm/W	18°/24°/36°/60°	LED	80			





ÜRÜN ÖZELLİKLERİ/PRODUCT SPECIFICATIONS

Ürün Tanımı	Magnet Ray Spot	Product Descripton	Magnet Track Spot
Gövde	Metal Gövde	Body	Metal Body
Boya	Elektrostatik Toz Boya	Paint	Elektrostatic Powder Coated
PCB		PCB	
Lens		Lens	
Reflektör	Pleksi	Reflector	Plexi
Difüzör		Diffuser	
SDCM (MacAdam)	3	SDCM (MacAdam)	3
Renk Sıcaklığı	3000K	Colour Temperature	3000K
Ömür	50000h	Life Time	50000h
Çalışma Sıcaklığı	25°C	Operating Temperature	25°C
LED	Osram/Samsung	LED	Osram/Samsung
Sürücü		Driver	
Uygunluk	EN 60598-1 EN 60598-2-2	Conformity	EN 60598-1 EN 60598-2-2

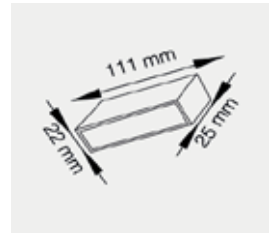

Ürün Kodu Product Code	Güç Power	Çıkış Işık Akısı Lumen Output	Verimlilik Efficiency	Işık Açısı Beam Angle	Işık Kaynağı Light Source	CRI	L (mm)	W (mm)	H (mm)
28149	6X1W	800lm	95Lm/W	18°/24°/36°/60°	LED	80	111	25	22



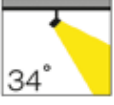

ÜRÜN ÖZELLİKLERİ/PRODUCT SPECIFICATIONS

Ürün Tanımı	Magnet Ray Spot	Product Descripton	Magnet Track Spot
Gövde	Metal Gövde	Body	Metal Body
Boya	Elektrostatik Toz Boya	Paint	Elektrostatic Powder Coated
PCB		PCB	
Lens		Lens	
Reflektör	Pleksi	Reflector	Plexi
Difüzör		Diffuser	
SDCM (MacAdam)	3	SDCM (MacAdam)	3
Renk Sıcaklığı	3000K	Colour Temperature	3000K
Ömür	50000h	Life Time	50000h
Çalışma Sıcaklığı	25°C	Operating Temperature	25°C
LED	Osram/Samsung	LED	Osram/Samsung
Sürücü		Driver	
Uygunluk	EN 60598-1 EN 60598-2-2	Conformity	EN 60598-1 EN 60598-2-2

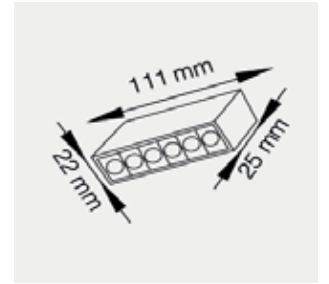

Ürün Kodu Product Code	Güç Power	Çıkış Işık Akısı Lumen Output	Verimlilik Efficiency	Işık Açısı Beam Angle	Işık Kaynağı Light Source	CRI	L (mm)	W (mm)	H (mm)
28150	6X1W	800lm	95Lm/W	34°	LED	80	111	25	22





ÜRÜN ÖZELLİKLERİ/PRODUCT SPECIFICATIONS

Ürün Tanımı	Magnet Ray Spot	Product Description	Magnet Track Spot
Gövde	Metal Gövde	Body	Metal Body
Boya	Elektrostatik Toz Boya	Paint	Elektrostatic Powder Coated
PCB		PCB	
Lens		Lens	
Reflektör	Pleksi	Reflector	Plexi
Difüzör		Diffuser	
SDCM (MacAdam)	3	SDCM (MacAdam)	3
Renk Sıcaklığı	3000K	Colour Temperature	3000K
Ömür	50000h	Life Time	50000h
Çalışma Sıcaklığı	25°C	Operating Temperature	25°C
LED	Osram/Samsung	LED	Osram/Samsung
Sürücü		Driver	
Uygunluk	EN 60598-1 EN 60598-2-2	Conformity	EN 60598-1 EN 60598-2-2

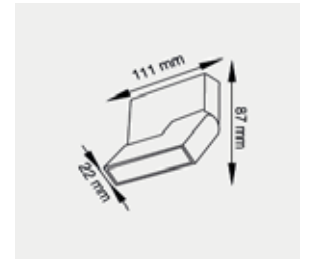

Ürün Kodu Product Code	Güç Power	Çıkış Işık Akısı Lumen Output	Verimlilik Efficiency	Işık Açısı Beam Angle	Işık Kaynağı Light Source	CRI	L (mm)	W (mm)	H (mm)
28151	6X1W	800lm	95Lm/W	34°	LED	80	111	87	22



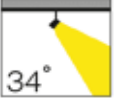

ÜRÜN ÖZELLİKLERİ/PRODUCT SPECIFICATIONS

Ürün Tanımı	Magnet Ray Spot	Product Descripton	Magnet Track Spot
Gövde	Metal Gövde	Body	Metal Body
Boya	Elektrostatik Toz Boya	Paint	Elektrostatic Powder Coated
PCB		PCB	
Lens		Lens	
Reflektör	Pleksi	Reflector	Plexi
Difüzör		Diffuser	
SDCM (MacAdam)	3	SDCM (MacAdam)	3
Renk Sıcaklığı	3000K	Colour Temperature	3000K
Ömür	50000h	Life Time	50000h
Çalışma Sıcaklığı	25°C	Operating Temperature	25°C
LED	Osram/Samsung	LED	Osram/Samsung
Sürücü		Driver	
Uygunluk	EN 60598-1 EN 60598-2-2	Conformity	EN 60598-1 EN 60598-2-2

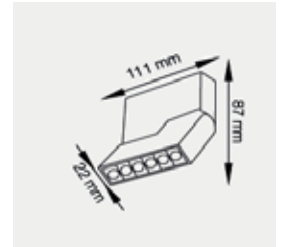

Ürün Kodu Product Code	Güç Power	Çıkış Işık Akısı Lumen Output	Verimlilik Efficiency	Işık Açısı Beam Angle	Işık Kaynağı Light Source	CRI	L (mm)	W (mm)	H (mm)
28152	6X1W	800Lm	95Lm/W	34°	LED	80	111	87	22



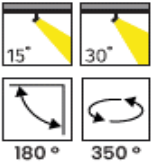

ÜRÜN ÖZELLİKLERİ/PRODUCT SPECIFICATIONS

Ürün Tanımı	Ray Spot	Product Description	Track Spot
Gövde	Alüminyum Enjeksiyon	Body	Aluminum Injection
Boya	Elektrostatik Toz Boya	Paint	Electrostatic Powder Coated
PCB		PCB	
Lens		Lens	
Reflektör	Yüksek Safılıkta Alüminyum	Reflector	High Purity Aluminum
Difüzör		Diffuser	
SDCM (MacAdam)	3	SDCM (MacAdam)	3
Renk Sıcaklığı	3000K	Colour Temperature	3000K
Ömür	50000h	Life Time	50000h
Çalışma Sıcaklığı	25°C	Operating Temperature	25°C
LED		LED	
Sürücü		Driver	
Uygunluk	EN 60598-1 EN 60598-2-2	Conformity	EN 60598-1 EN 60598-2-2

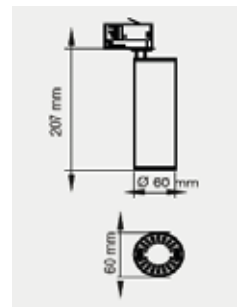

Ürün Kodu Product Code	Güç Power	Çıkış Işık Akısı Lumen Output	Verimlilik Efficiency	Işık Açısı Beam Angle	Işık Kaynağı Light Source	CRI	L (mm)	W (mm)
28139	5W	350Lm	70Lm/W	35°	GU10	80	207	60



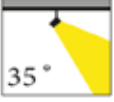

ÜRÜN ÖZELLİKLERİ/PRODUCT SPECIFICATIONS

Ürün Tanımı	Ray Spot	Product Description	Track Spot
Gövde	Alüminyum	Body	Aluminum Housing
Boya	Elektrostatik Toz Boya	Paint	Elektrostatic Powder Coated
PCB	Tek Faz Ray Socketsi	PCB	With Single Phase Track Adapter
Lens		Lens	
Reflektör		Reflector	
Difüzör		Diffuser	
SDCM (MacAdam)	3	SDCM (MacAdam)	3
Renk Sıcaklığı	3000K	Colour Temperature	3000K
Ömür	50000h	Life Time	50000h
Çalışma Sıcaklığı	25°C	Operating Temperature	25°C
LED		LED	
Sürücü		Driver	
Uygunluk	EN 60598-1 EN 60598-2-2	Conformity	EN 60598-1 EN 60598-2-2

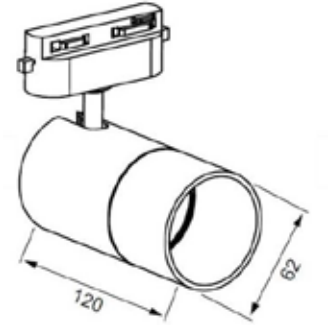

Ürün Kodu Product Code	Güç Power	Çıkış Işık Akısı Lumen Output	Verimlilik Efficiency	Işık Açısı Beam Angle	Işık Kaynağı Light Source	CRI	L (mm)	W (mm)	H (mm)
28004-2	5W	350Lm	70Lm/W	35°	GU10	80	120	62	





1



2



ÜRÜN ÖZELLİKLERİ/PRODUCT SPECIFICATIONS

Ürün Tanımı	Ray Spot	Product Descripton	Track Spot
Gövde	Alüminyum Enjeksiyon	Body	Die-Cast Aluminum Housing
Boya	Elektrostatik Toz Boya	Paint	Elektrostatic Powder Coated
PCB	Tek Faz Ray Socketsi	PCB	With Single Phase Track Adapter
Lens		Lens	
Reflektör		Reflector	
Difüzör		Diffuser	
SDCM (MacAdam)	3	SDCM (MacAdam)	3
Renk Sıcaklığı	3000K	Colour Temperature	3000K
Ömür	50000h	Life Time	50000h
Çalışma Sıcaklığı	25°C	Operating Temperature	25°C
LED		LED	
Sürücü		Driver	
Uygunluk	EN 60598-1 EN 60598-2-2	Conformity	EN 60598-1 EN 60598-2-2

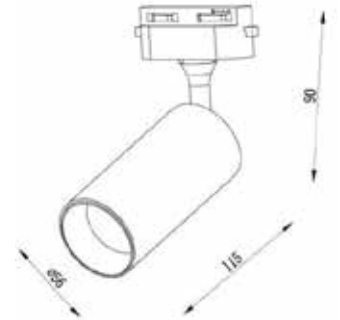

Ürün Kodu Product Code	Güç Power	Çıkış Işık Akısı Lumen Output	Verimlilik Efficiency	Işık Açısı Beam Angle	Işık Kaynağı Light Source	CRI	L (mm)	W (mm)	H (mm)
28105-X	5W	350Lm	70Lm/W	35°	GU10	80	115	56	90



RAY SPOT/TRACK SPOTLIGHT



ÜRÜN ÖZELLİKLERİ/PRODUCT SPECIFICATIONS

Ürün Tanımı	Ray Spot	Product Descripton	Track Spot
Gövde	Alüminyum Enjeksiyon	Body	Die-Cast Aluminum Housing
Boya	Elektrostatik Toz Boya	Paint	Elektrostatic Powder Coated
PCB		PCB	
Lens		Lens	
Reflektör	Yüksek Safılıkta Alüminyum	Reflector	High Purity Aluminum
Difüzör		Diffuser	
SDCM (MacAdam)	3	SDCM (MacAdam)	3
Renk Sıcaklığı	3000K	Colour Temperature	3000K
Ömür	50000h	Life Time	50000h
Çalışma Sıcaklığı	25°C	Operating Temperature	25°C
LED		LED	
Sürücü		Driver	
Uygunluk	EN 60598-1 EN 60598-2-2	Conformity	EN 60598-1 EN 60598-2-2

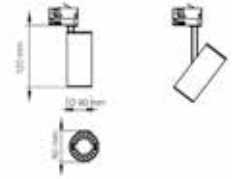

Ürün Kodu Product Code	Güç Power	Çıkış Işık Akısı Lumen Output	Verimlilik Efficiency	Işık Açısı Beam Angle	Işık Kaynağı Light Source	CRI	L (mm)	W (mm)	H (mm)
28120	5W	460Lm	92Lm/W	35°	GU10	80	60	60	120
28121	8W	670Lm	83Lm/W	35°	GU10	80	60	60	120



RAY SPOT/TRACK SPOTLIGHT



ÜRÜN ÖZELLİKLERİ/PRODUCT SPECIFICATIONS

Ürün Tanımı	Ray Spot	Product Description	Track Spot
Gövde	Alüminyum Enjeksiyon	Body	Die-Cast Aluminum
Boya	Elektrostatik Toz Boya	Paint	Elektrostatic Powder Coated
PCB		PCB	
Lens		Lens	
Reflektör	Yüksek Safılıkta Alüminyum	Reflector	High Purity Aluminum
Difüzör		Diffuser	
SDCM (MacAdam)	3	SDCM (MacAdam)	3
Renk Sıcaklığı	2700K/3000K/4000K	Colour Temperature	2700K/3000K/4000K
Ömür	50000h	Life Time	50000h
Çalışma Sıcaklığı	25°C	Operating Temperature	25°C
LED		LED	
Sürücü		Driver	
Uygunluk	EN 60598-1 EN 60598-2-2	Conformity	EN 60598-1 EN 60598-2-2

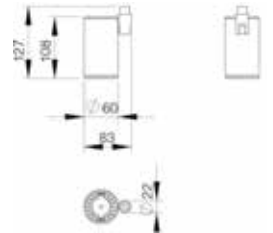

Ürün Kodu Product Code	Güç Power	Çıkış Işık Akısı Lumen Output	Verimlilik Efficiency	Işık Açısı Beam Angle	Işık Kaynağı Light Source	CRI	L (mm)	W (mm)	H (mm)
28058	5W	350lm	70Lm/W	35°	GU10	80	83	60	127



RAY SPOT/TRACK SPOTLIGHT



ÜRÜN ÖZELLİKLERİ/PRODUCT SPECIFICATIONS

Ürün Tanımı	Ray Spot	Product Description	Track Spot
Gövde	Alüminyum Enjeksiyon	Body	Die-Cast Aluminum
Boya	Elektrostatik Toz Boya	Paint	Electrostatic Powder Coated
PCB		PCB	
Lens		Lens	
Reflektör	Yüksek Safılıkta Alüminyum	Reflector	High Purity Aluminum
Difüzör		Diffuser	
SDCM (MacAdam)	3	SDCM (MacAdam)	3
Renk Sıcaklığı	2700K/3000K/4000K	Colour Temperature	2700K/3000K/4000K
Ömür	50000h	Life Time	50000h
Çalışma Sıcaklığı	25°C	Operating Temperature	25°C
LED		LED	
Sürücü		Driver	
Uygunluk	EN 60598-1 EN 60598-2-2	Conformity	EN 60598-1 EN 60598-2-2

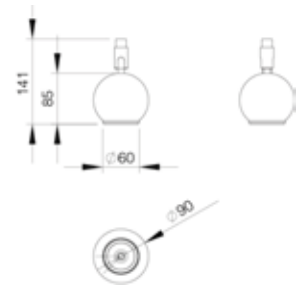

Ürün Kodu Product Code	Güç Power	Çıkış Işık Akısı Lumen Output	Verimlilik Efficiency	Işık Açısı Beam Angle	Işık Kaynağı Light Source	CRI	L (mm)	W (mm)	H (mm)
28044	5W	350Lm	70Lm/W	35°	GU10	80	60	60	141



RAY SPOT/TRACK SPOTLIGHT



ÜRÜN ÖZELLİKLERİ/PRODUCT SPECIFICATIONS

Ürün Tanımı	Ray Spot	Product Description	Track Spot
Gövde	Alüminyum Enjeksiyon	Body	Die-Cast Aluminum
Boya	Elektrostatik Toz Boya	Paint	Elektrostatic Powder Coated
PCB		PCB	
Lens		Lens	
Reflektör	Yüksek Safılıkta Alüminyum	Reflector	High Purity Aluminum
Difüzör		Diffuser	
SDCM (MacAdam)	3	SDCM (MacAdam)	3
Renk Sıcaklığı	2700K/3000K/4000K	Colour Temperature	2700K/3000K/4000K
Ömür	50000h	Life Time	50000h
Çalışma Sıcaklığı	25°C	Operating Temperature	25°C
LED		LED	
Sürücü		Driver	
Uygunluk	EN 60598-1 EN 60598-2-2	Conformity	EN 60598-1 EN 60598-2-2

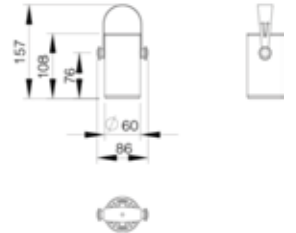

Ürün Kodu Product Code	Güç Power	Çıkış Işık Akısı Lumen Output	Verimlilik Efficiency	Işık Açısı Beam Angle	Işık Kaynağı Light Source	CRI	L (mm)	W (mm)	H (mm)
28067	5W	350Lm	70Lm/W	35°	GU10	80	86	60	157





ÜRÜN ÖZELLİKLERİ/PRODUCT SPECIFICATIONS

Ürün Tanımı	Ray Spot	Product Description	Track Spot
Gövde	Alüminyum Enjeksiyon	Body	Die-Cast Aluminum Housing
Boya	Elektrostatik Toz Boya	Paint	Electrostatic Powder Coated
PCB		PCB	
Lens		Lens	
Reflektör	Yüksek Safılıkta Alüminyum	Reflector	High Purity Aluminum
Difüzör		Diffuser	
SDCM (MacAdam)	3	SDCM (MacAdam)	3
Renk Sıcaklığı	3000K	Colour Temperature	3000K
Ömür	50000h	Life Time	50000h
Çalışma Sıcaklığı	25°C	Operating Temperature	25°C
LED	Cree	LED	Cree
Sürücü		Driver	
Uygunluk	EN 60598-1 EN 60598-2-2	Conformity	EN 60598-1 EN 60598-2-2

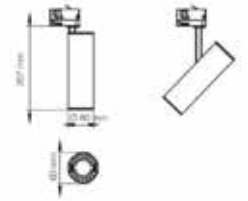

Ürün Kodu Product Code	Güç Power	Çıkış Işık Akısı Lumen Output	Verimlilik Efficiency	Işık Açısı Beam Angle	Işık Kaynağı Light Source	CRI	L (mm)	W (mm)	H (mm)
28126	8W	587Lm	73Lm/W	15°/30°/45°/60°	LED	80	60	60	207
28127	10W	654Lm	65Lm/W	15°/30°/45°/60°	LED	80	60	60	207



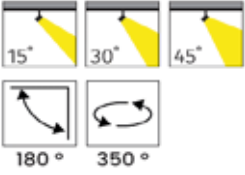

ÜRÜN ÖZELLİKLERİ/PRODUCT SPECIFICATIONS

Ürün Tanımı	Ray Spot	Product Description	Track Spot
Gövde	Alüminyum Enjeksiyon	Body	Die-Cast Aluminum Housing
Boya	Elektrostatik Toz Boya	Paint	Electrostatic Powder Coated
PCB		PCB	
Lens		Lens	
Reflektör	Yüksek Safılıkta Alüminyum	Reflector	High Purity Aluminum
Difüzör		Diffuser	
SDCM (MacAdam)	3	SDCM (MacAdam)	3
Renk Sıcaklığı	3000K	Colour Temperature	3000K
Ömür	50000h	Life Time	50000h
Çalışma Sıcaklığı	25°C	Operating Temperature	25°C
LED	Cree	LED	Cree
Sürücü		Driver	
Uygunluk	EN 60598-1 EN 60598-2-2	Conformity	EN 60598-1 EN 60598-2-2

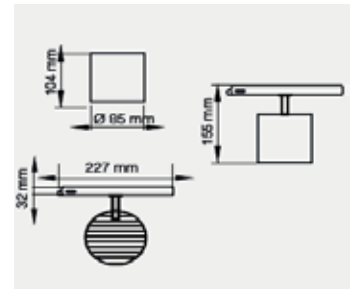

Ürün Kodu Product Code	Güç Power	Çıkış Işık Akısı Lumen Output	Verimlilik Efficiency	Işık Açısı Beam Angle	Işık Kaynağı Light Source	CRI	L (mm)	W (mm)	H (mm)
28122	15W	1242Lm	88Lm/W	15°/30°/45°	LED	80	104	85	155
28123	20W	1774Lm	88Lm/W	15°/30°/45°	LED	80	104	85	155



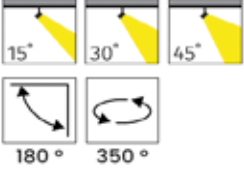

ÜRÜN ÖZELLİKLERİ/PRODUCT SPECIFICATIONS

Ürün Tanımı	Ray Spot	Product Description	Track Spot
Gövde	Alüminyum Enjeksiyon	Body	Die-Cast Aluminum Housing
Boya	Elektrostatik Toz Boya	Paint	Electrostatic Powder Coated
PCB		PCB	
Lens		Lens	
Reflektör	Yüksek Safılıkta Alüminyum	Reflector	High Purity Aluminum
Difüzör		Diffuser	
SDCM (MacAdam)	3	SDCM (MacAdam)	3
Renk Sıcaklığı	3000K	Colour Temperature	3000K
Ömür	50000h	Life Time	50000h
Çalışma Sıcaklığı	25°C	Operating Temperature	25°C
LED	Cree	LED	Cree
Sürücü		Driver	
Uygunluk	EN 60598-1 EN 60598-2-2	Conformity	EN 60598-1 EN 60598-2-2

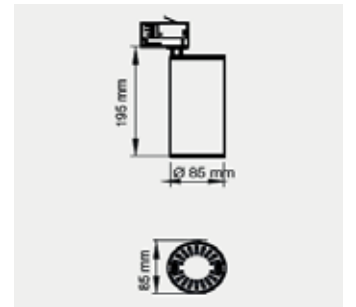

Ürün Kodu Product Code	Güç Power	Çıkış Işık Akısı Lumen Output	Verimlilik Efficiency	Işık Açısı Beam Angle	Işık Kaynağı Light Source	CRI	L (mm)	W (mm)	H (mm)
28128	15W	1242Lm	88Lm/W	15°/30°/45°	LED	80	85	85	195
28129	20W	1774Lm	88Lm/W	15°/30°/45°	LED	80	85	85	195





ÜRÜN ÖZELLİKLERİ/PRODUCT SPECIFICATIONS

Ürün Tanımı	Ray Spot	Product Description	Track Spot
Gövde	Alüminyum Enjeksiyon	Body	Die-Cast Aluminum
Boya	Elektrostatik Toz Boya	Paint	Elektrostatic Powder Coated
PCB		PCB	
Lens		Lens	
Reflektör	Yüksek Safılıkta Alüminyum	Reflector	High Purity Aluminum
Difüzör		Diffuser	
SDCM (MacAdam)	3	SDCM (MacAdam)	3
Renk Sıcaklığı	2700K/3000K/4000K	Colour Temperature	2700K/3000K/4000K
Ömür	50000h	Life Time	50000h
Çalışma Sıcaklığı	25°C	Operating Temperature	25°C
LED	Osram/Tridonic/Nichia Samsung/Cree	LED	Osram/Tridonic/Nichia Samsung/Cree
Sürücü		Driver	
Uygunluk	EN 60598-1 EN 60598-2-1	Conformity	EN 60598-1 EN 60598-2-1

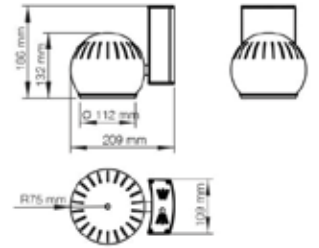

Ürün Kodu Product Code	Güç Power	Çıkış Işık Akısı Lumen Output	Verimlilik Efficiency	Işık Açısı Beam Angle	Işık Kaynağı Light Source	CRI	L (mm)	W (mm)	H (mm)
28035	25W	2425Lm	97Lm/W	15°/30°/45°/60°	LED	80	209	112	186
28036	30W	2938Lm	97Lm/W	15°/30°/45°/60°	LED	80	209	112	186
28037	35W	3256Lm	93Lm/W	15°/30°/45°/60°	LED	80	209	112	186



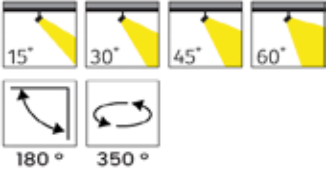

ÜRÜN ÖZELLİKLERİ/PRODUCT SPECIFICATIONS

Ürün Tanımı	Ray Spot	Product Description	Track Spot
Gövde	Alüminyum Enjeksiyon	Body	Die-Cast Aluminum
Boya	Elektrostatik Toz Boya	Paint	Electrostatic Powder Coated
PCB		PCB	
Lens		Lens	
Reflektör	Yüksek Safılıkta Alüminyum	Reflector	High Purity Aluminum
Difüzör		Diffuser	
SDCM (MacAdam)	3	SDCM (MacAdam)	3
Renk Sıcaklığı	2700K/3000K/4000K	Colour Temperature	2700K/3000K/4000K
Ömür	50000h	Life Time	50000h
Çalışma Sıcaklığı	25°C	Operating Temperature	25°C
LED	Osram/Tridonic/Nichia Samsung/Cree	LED	Osram/Tridonic/Nichia Samsung/Cree
Sürücü		Driver	
Uygunluk	EN 60598-1 EN 60598-2-1	Conformity	EN 60598-1 EN 60598-2-1

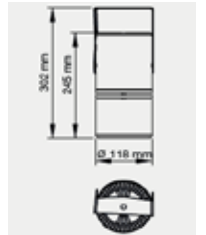

Ürün Kodu Product Code	Güç Power	Çıkış Işık Akısı Lumen Output	Verimlilik Efficiency	Işık Açısı Beam Angle	Işık Kaynağı Light Source	CRI	L (mm)	W (mm)	H (mm)
28072	25W	2425Lm	97Lm/W	15°/30°/45°/60°	LED	80	118	118	302
28073	30W	2938Lm	97Lm/W	15°/30°/45°/60°	LED	80	118	118	302
28074	35W	3256Lm	93Lm/W	15°/30°/45°/60°	LED	80	118	118	302



RAY SPOT/TRACK SPOTLIGHT

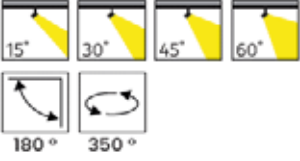

ÜRÜN ÖZELLİKLERİ/PRODUCT SPECIFICATIONS

Ürün Tanımı	Ray Spot	Product Description	Track Spot
Gövde	Alüminyum Enjeksiyon	Body	Die-Cast Aluminum
Boya	Elektrostatik Toz Boya	Paint	Electrostatic Powder Coated
PCB		PCB	
Lens		Lens	
Reflektör	Yüksek Safılıkta Alüminyum	Reflector	High Purity Aluminum
Difüzör		Diffuser	
SDCM (MacAdam)	3	SDCM (MacAdam)	3
Renk Sıcaklığı	2700K/3000K/4000K	Colour Temperature	2700K/3000K/4000K
Ömür	50000h	Life Time	50000h
Çalışma Sıcaklığı	25°C	Operating Temperature	25°C
LED	Osram/Tridonic/Nichia Samsung/Cree	LED	Osram/Tridonic/Nichia/Sa msung/Cree
Sürücü		Driver	
Uygunluk	EN 60598-1 EN 60598-2-1	Conformity	EN 60598-1 EN 60598-2-1

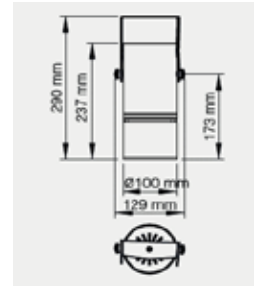

Ürün Kodu Product Code	Güç Power	Çıkış Işık Akısı Lumen Output	Verimlilik Efficiency	Işık Açısı Beam Angle	Işık Kaynağı Light Source	CRI	L (mm)	W (mm)	H (mm)
28075	25W	2425Lm	97Lm/W	15°/30°/45°/60°	LED	80	129	100	290
28076	30W	2938Lm	97Lm/W	15°/30°/45°/60°	LED	80	129	100	290
28077	35W	3256Lm	93Lm/W	15°/30°/45°/60°	LED	80	129	100	290



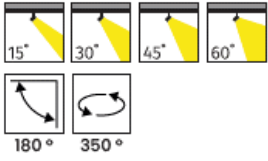

ÜRÜN ÖZELLİKLERİ/PRODUCT SPECIFICATIONS

Ürün Tanımı	Ray Spot	Product Description	Track Spot
Gövde	Alüminyum Enjeksiyon	Body	Die-Cast Aluminum
Boya	Elektrostatik Toz Boya	Paint	Elektrostatic Powder Coated
PCB		PCB	
Lens		Lens	
Reflektör	Yüksek Safılıkta Alüminyum	Reflector	High Purity Aluminum
Difüzör		Diffuser	
SDCM (MacAdam)	3	SDCM (MacAdam)	3
Renk Sıcaklığı	2700K/3000K/4000K	Colour Temperature	2700K/3000K/4000K
Ömür	50000h	Life Time	50000h
Çalışma Sıcaklığı	25°C	Operating Temperature	25°C
LED	Osram/Tridonic/Nichia Samsung/Cree	LED	Osram/Tridonic/Nichia Samsung/Cree
Sürücü		Driver	
Uygunluk	EN 60598-1 EN 60598-2-1	Conformity	EN 60598-1 EN 60598-2-1

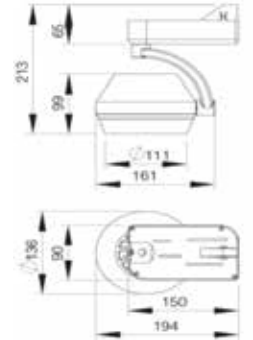

Ürün Kodu Product Code	Güç Power	Çıkış Işık Akısı Lumen Output	Verimlilik Efficiency	Işık Açısı Beam Angle	Işık Kaynağı Light Source	CRI	L (mm)	W (mm)	H (mm)
28104	20W	1940Lm	97Lm/W	15°/30°/45°/60°	LED	80	194	136	213
28087	25W	2425Lm	97Lm/W	15°/30°/45°/60°	LED	80	194	136	213
28088	30W	2938Lm	98Lm/W	15°/30°/45°/60°	LED	80	194	136	213



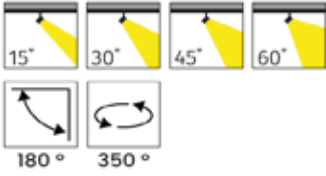

ÜRÜN ÖZELLİKLERİ/PRODUCT SPECIFICATIONS

Ürün Tanımı	Ray Spot	Product Description	Track Spot
Gövde	Alüminyum Enjeksiyon	Body	Die-Cast Aluminum
Boya	Elektrostatik Toz Boya	Paint	Elektrostatic Powder Coated
PCB		PCB	
Lens		Lens	
Reflektör	Yüksek Safılıkta Alüminyum	Reflector	High Purity Aluminum
Difüzör		Diffuser	
SDCM (MacAdam)	3	SDCM (MacAdam)	3
Renk Sıcaklığı	2700K/3000K/4000K	Colour Temperature	2700K/3000K/4000K
Ömür	50000h	Life Time	50000h
Çalışma Sıcaklığı	25°C	Operating Temperature	25°C
LED	Osram/Tridonic/Nichia Samsung/Cree	LED	Osram/Tridonic/Nichia Samsung/Cree
Sürücü		Driver	
Uygunluk	EN 60598-1 EN 60598-2-1	Conformity	EN 60598-1 EN 60598-2-1

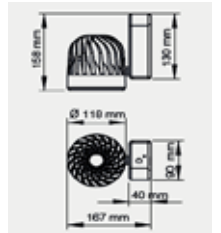

Ürün Kodu Product Code	Güç Power	Çıkış Işık Akısı Lumen Output	Verimlilik Efficiency	Işık Açısı Beam Angle	Işık Kaynağı Light Source	CRI	L (mm)	W (mm)	H (mm)
28089	25W	2425Lm	97Lm/W	15°/30°/45°/60°	LED	80	167	118	158
28090	30W	2938Lm	97Lm/W	15°/30°/45°/60°	LED	80	167	118	158
28091	35W	3256Lm	93Lm/W	15°/30°/45°/60°	LED	80	167	118	158
28092	40W	3537Lm	85Lm/W	15°/30°/45°/60°	LED	80	167	118	158



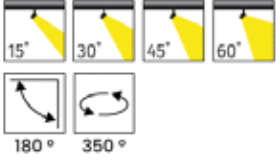

ÜRÜN ÖZELLİKLERİ/PRODUCT SPECIFICATIONS

Ürün Tanımı	Ray Spot	Product Descripton	Track Spot
Gövde	Alüminyum Enjeksiyon	Body	Die-Cast Aluminum
Boya	Elektrostatik Toz Boya	Paint	Elektrostatic Powder Coated
PCB		PCB	
Lens		Lens	
Reflektör	Yüksek Safılıkta Alüminyum	Reflector	High Purity Aluminum
Difüzör		Diffuser	
SDCM (MacAdam)	3	SDCM (MacAdam)	3
Renk Sıcaklığı	2700K/3000K/4000K	Colour Temperature	2700K/3000K/4000K
Ömür	50000h	Life Time	50000h
Çalışma Sıcaklığı	25°C	Operating Temperature	25°C
LED	Osram/Tridonic/Nichia Samsung/Cree	LED	Osram/Tridonic/Nichia Samsung/Cree
Sürücü		Driver	
Uygunluk	EN 60598-1 EN 60598-2-1	Conformity	EN 60598-1 EN 60598-2-1

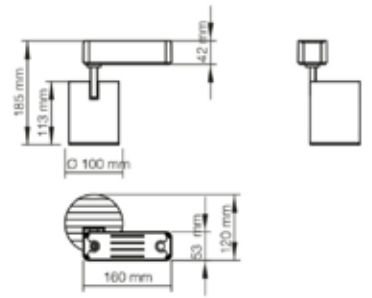

Ürün Kodu Product Code	Güç Power	Çıkış Işık Akısı Lumen Output	Verimlilik Efficiency	Işık Açısı Beam Angle	Işık Kaynağı Light Source	CRI	L (mm)	W (mm)	H (mm)
28093	25W	2425Lm	97Lm/W	15°/30°/45°/60°	LED	80	100	100	185
28094	30W	2938Lm	98Lm/W	15°/30°/45°/60°	LED	80	100	100	185



RAY SPOT/TRACK SPOTLIGHT

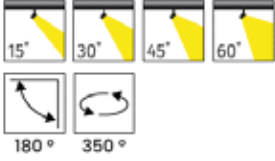

ÜRÜN ÖZELLİKLERİ/PRODUCT SPECIFICATIONS

Ürün Tanımı	Ray Spot	Product Description	Track Spot
Gövde	Alüminyum Enjeksiyon	Body	Die-Cast Aluminum
Boya	Elektrostatik Toz Boya	Paint	Elektrostatic Powder Coated
PCB		PCB	
Lens		Lens	
Reflektör	Yüksek Safılıkta Alüminyum	Reflector	High Purity Aluminum
Difüzör		Diffuser	
SDCM (MacAdam)	3	SDCM (MacAdam)	3
Renk Sıcaklığı	2700K/3000K/4000K	Colour Temperature	2700K/3000K/4000K
Ömür	50000h	Life Time	50000h
Çalışma Sıcaklığı	25°C	Operating Temperature	25°C
LED	Osram/Tridonic/Nichia Samsung/Cree	LED	Osram/Tridonic/Nichia Samsung/Cree
Sürücü		Driver	
Uygunluk	EN 60598-1 EN 60598-2-1	Conformity	EN 60598-1 EN 60598-2-1

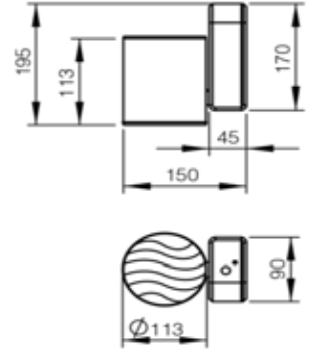

Ürün Kodu Product Code	Güç Power	Çıkış Işık Akısı Lumen Output	Verimlilik Efficiency	Işık Açısı Beam Angle	Işık Kaynağı Light Source	CRI	L (mm)	W (mm)	H (mm)
28095	25W	2425Lm	97Lm/W	15°/30°/45°/60°	LED	80	113	150	195
28096	30W	2938Lm	97Lm/W	15°/30°/45°/60°	LED	80	113	150	195



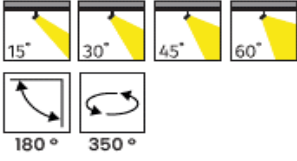

ÜRÜN ÖZELLİKLERİ/PRODUCT SPECIFICATIONS

Ürün Tanımı	Ray Spot	Product Description	Track Spot
Gövde	Alüminyum Enjeksiyon	Body	Die-Cast Aluminum
Boya	Elektrostatik Toz Boya	Paint	Elektrostatic Powder Coated
PCB		PCB	
Lens		Lens	
Reflektör	Yüksek Safılıkta Alüminyum	Reflector	High Purity Aluminum
Difüzör		Diffuser	
SDCM (MacAdam)	3	SDCM (MacAdam)	3
Renk Sıcaklığı	2700K/3000K/4000K	Colour Temperature	2700K/3000K/4000K
Ömür	50000h	Life Time	50000h
Çalışma Sıcaklığı	25°C	Operating Temperature	25°C
LED	Osram/Tridonic/Nichia Samsung/Cree	LED	Osram/Tridonic/Nichia Samsung/Cree
Sürücü		Driver	
Uygunluk	EN 60598-1 EN 60598-2-1	Conformity	EN 60598-1 EN 60598-2-1

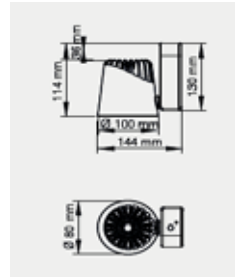

Ürün Kodu Product Code	Güç Power	Çıkış Işık Akısı Lumen Output	Verimlilik Efficiency	Işık Açısı Beam Angle	Işık Kaynağı Light Source	CRI	L (mm)	W (mm)	H (mm)
28099	25W	2425Lm	97Lm/W	15°/30°/45°/60°	LED	80	144	100	150
28100	30W	2938Lm	97Lm/W	15°/30°/45°/60°	LED	80	144	100	150





ÜRÜN ÖZELLİKLERİ/PRODUCT SPECIFICATIONS

Ürün Tanımı	Ray Spot	Product Description	Track Spot
Gövde	Alüminyum Enjeksiyon	Body	Die-Cast Aluminum
Boya	Elektrostatik Toz Boya	Paint	Electrostatic Powder Coated
PCB		PCB	
Lens		Lens	
Reflektör	Yüksek Safılıkta Alüminyum	Reflector	High Purity Aluminum
Difüzör		Diffuser	
SDCM (MacAdam)	3	SDCM (MacAdam)	3
Renk Sıcaklığı	2700K/3000K/4000K	Colour Temperature	2700K/3000K/4000K
Ömür	50000h	Life Time	50000h
Çalışma Sıcaklığı	25°C	Operating Temperature	25°C
LED	Osram/Tridonic/Nichia Samsung/Cree	LED	Osram/Tridonic/Nichia Samsung/Cree
Sürücü		Driver	
Uygunluk	EN 60598-1 EN 60598-2-1	Conformity	EN 60598-1 EN 60598-2-1

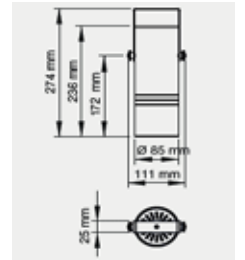

Ürün Kodu Product Code	Güç Power	Çıkış Işık Akısı Lumen Output	Verimlilik Efficiency	Işık Açısı Beam Angle	Işık Kaynağı Light Source	CRI	L (mm)	W (mm)	H (mm)
28078	10W	654Lm	65Lm/W	15°/30°/45°	LED	80	111	84	274
28079	15W	1242Lm	82Lm/W	15°/30°/45°	LED	80	111	84	274
28080	20W	1774Lm	90Lm/W	15°/30°/45°	LED	80	111	84	274



RAY SPOT/TRACK SPOTLIGHT

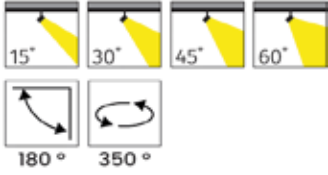

ÜRÜN ÖZELLİKLERİ/PRODUCT SPECIFICATIONS

Ürün Tanımı	Ray Spot	Product Description	Track Spot
Gövde	Alüminyum Enjeksiyon	Body	Die-Cast Aluminum Housing
Boya	Elektrostatik Toz Boya	Paint	Elektrostatic Powder Coated
PCB		PCB	
Lens		Lens	
Reflektör	Yüksek Safılıkta Alüminyum	Reflector	High Purity Aluminum
Difüzör		Diffuser	
SDCM (MacAdam)	3	SDCM (MacAdam)	3
Renk Sıcaklığı	3000K	Colour Temperature	3000K
Ömür	50000h	Life Time	50000h
Çalışma Sıcaklığı	25°C	Operating Temperature	25°C
LED	Cree	LED	Cree
Sürücü		Driver	
Uygunluk	EN 60598-1 EN 60598-2-2	Conformity	EN 60598-1 EN 60598-2-2

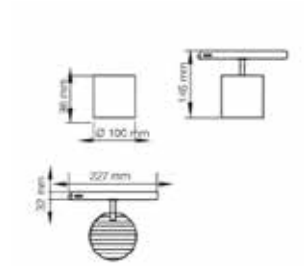

Ürün Kodu Product Code	Güç Power	Çıkış Işık Akısı Lumen Output	Verimlilik Efficiency	Işık Açısı Beam Angle	Işık Kaynağı Light Source	CRI	L (mm)	W (mm)	H (mm)
28124	20W	1774Lm	88Lm/W	15°/30°/45°/60°	LED	80	98	100	145
28125	30W	2938Lm	97Lm/W	15°/30°/45°/60°	LED	80	98	100	145



RAY SPOT/TRACK SPOTLIGHT

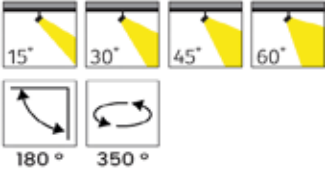

ÜRÜN ÖZELLİKLERİ/PRODUCT SPECIFICATIONS

Ürün Tanımı	Ray Spot	Product Description	Track Spot
Gövde	Alüminyum Enjeksiyon	Body	Die-Cast Aluminum Housing
Boya	Elektrostatik Toz Boya	Paint	Elektrostatic Powder Coated
PCB		PCB	
Lens		Lens	
Reflektör	Yüksek Safılıkta Alüminyum	Reflector	High Purity Aluminum
Difüzör		Diffuser	
SDCM (MacAdam)	3	SDCM (MacAdam)	3
Renk Sıcaklığı	3000K	Colour Temperature	3000K
Ömür	50000h	Life Time	50000h
Çalışma Sıcaklığı	25°C	Operating Temperature	25°C
LED	Cree	LED	Cree
Sürücü		Driver	
Uygunluk	EN 60598-1 EN 60598-2-2	Conformity	EN 60598-1 EN 60598-2-2

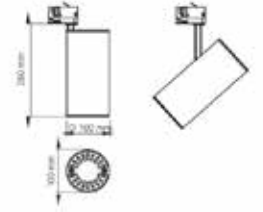

Ürün Kodu Product Code	Güç Power	Çıkış Işık Akısı Lumen Output	Verimlilik Efficiency	Işık Açısı Beam Angle	Işık Kaynağı Light Source	CRI	L (mm)	W (mm)	H (mm)
28130	20W	1774Lm	88Lm/W	15°/30°/45°/60°	LED	80	100	100	260
28131	30W	2938Lm	97Lm/W	15°/30°/45°/60°	LED	80	100	100	260



RAY SPOT/TRACK SPOTLIGHT



ÜRÜN ÖZELLİKLERİ/PRODUCT SPECIFICATIONS

Ürün Tanımı	Ray Spot	Product Description	Track Spot
Gövde	Alüminyum Enjeksiyon	Body	Die-Cast Aluminum Housing
Boya	Elektrostatik Toz Boya	Paint	Electrostatic Powder Coated
PCB		PCB	
Lens		Lens	
Reflektör	Yüksek Safılıkta Alüminyum	Reflector	High Purity Aluminum
Difüzör		Diffuser	
SDCM (MacAdam)	3	SDCM (MacAdam)	3
Renk Sıcaklığı	3000K	Colour Temperature	3000K
Ömür	50000h	Life Time	50000h
Çalışma Sıcaklığı	25°C	Operating Temperature	25°C
LED	Cree	LED	Cree
Sürücü		Driver	
Uygunluk	EN 60598-1 EN 60598-2-2	Conformity	EN 60598-1 EN 60598-2-2

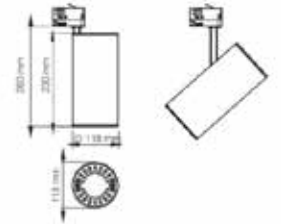

Ürün Kodu Product Code	Güç Power	Çıkış Işık Akısı Lumen Output	Verimlilik Efficiency	Işık Açısı Beam Angle	Işık Kaynağı Light Source	CRI	L (mm)	W (mm)	H (mm)
28132	30W	2938Lm	97Lm/W	15°/30°/45°/60°	LED	80	118	118	260
28133	35W	3256Lm	93Lm/W	15°/30°/45°/60°	LED	80	118	118	260



Sıva Altı Spot



Recessed Spot

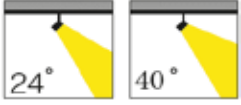

ÜRÜN ÖZELLİKLERİ/PRODUCT SPECIFICATIONS

Ürün Tanımı	Sıva Altı Spot	Product Description	Recessed Downlight
Gövde	Alüminyum Ekstrüzyon	Body	Aluminum Extrusion
Boya	Elektrostatik Toz Boya	Paint	Electrostatic Powder Coated
PCB		PCB	
Lens	PC	Lens	PC
Reflektör		Reflector	
Difüzör	Şeffaf	Diffuser	Transparent
SDCM (MacAdam)	3	SDCM (MacAdam)	3
Renk Sıcaklığı	2700K/6500K	Colour Temperature	2700K/6500K
Ömür	50000h	Life Time	50000h
Çalışma Sıcaklığı	25°C	Operating Temperature	25°C
LED	Samsung	LED	Samsung
Sürücü		Driver	
Uygunluk	EN 60598-1 EN 60598-2-2	Conformity	EN 60598-1 EN 60598-2-2

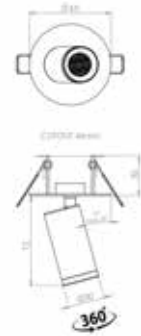

Ürün Kodu Product Code	Güç Power	Çıkış Işık Akısı Lumen Output	Verimlilik Efficiency	Işık Açısı Beam Angle	Işık Kaynağı Light Source	CRI	Ø (mm)	CUT (mm)	H (mm)
21343	2,5W	320Lm	128Lm/W	24°/40°	LED	80	65	46	72
21344	5W	640Lm	128Lm/W	24°/40°	LED	80	65	46	72





ÜRÜN ÖZELLİKLERİ/PRODUCT SPECIFICATIONS

Ürün Tanımı	Sıva Altı Hareketli Spot	Product Description	Recessed Downlight
Gövde	Alüminyum	Body	Aluminum Housing
Boya	Elektrostatik Toz Boya	Paint	Electrostatic Powder Coated
PCB		PCB	
Lens		Lens	
Reflektör		Reflector	
Difüzör	Şeffaf	Diffuser	Transparent
SDCM (MacAdam)	3	SDCM (MacAdam)	3
Renk Sıcaklığı	2700K/6500K	Colour Temperature	2700K/6500K
Ömür	50000h	Life Time	50000h
Çalışma Sıcaklığı	25°C	Operating Temperature	25°C
LED	Samsung	LED	Samsung
Sürücü		Driver	
Uygunluk	EN 60598-1 EN 60598-2-2	Conformity	EN 60598-1 EN 60598-2-2

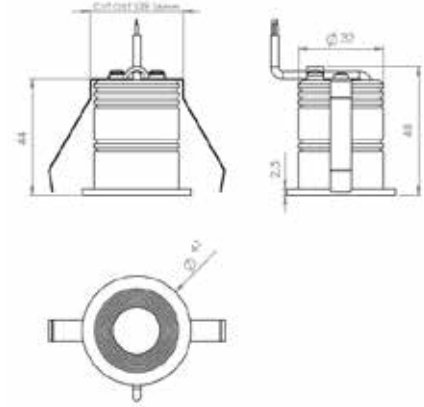

Ürün Kodu Product Code	Güç Power	Çıkış Işık Akısı Lumen Output	Verimlilik Efficiency	Işık Açısı Beam Angle	Işık Kaynağı Light Source	CRI	Ø (mm)	CUT (mm)	H (mm)
21329	3W	238Lm	85Lm/W	12°/24°/36°/48°	LED	80	41	36	48





ÜRÜN ÖZELLİKLERİ/PRODUCT SPECIFICATIONS

Ürün Tanımı	Siva Altı Hareketli Spot	Product Description	Recessed Downlight
Gövde	Alüminyum	Body	Aluminum Housing
Boya	Elektrostatik Toz Boya	Paint	Electrostatic Powder Coated
PCB		PCB	
Lens		Lens	
Reflektör		Reflector	
Difüzör	Şeffaf	Diffuser	Transparent
SDCM (MacAdam)	3	SDCM (MacAdam)	3
Renk Sıcaklığı	2700K/6500K	Colour Temperature	2700K/6500K
Ömür	50000h	Life Time	50000h
Çalışma Sıcaklığı	25°C	Operating Temperature	25°C
LED	Samsung	LED	Samsung
Sürücü		Driver	
Uygunluk	EN 60598-1 EN 60598-2-2	Conformity	EN 60598-1 EN 60598-2-2

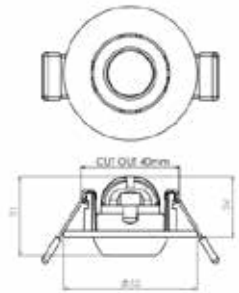

Ürün Kodu Product Code	Güç Power	Çıkış Işık Akısı Lumen Output	Verimlilik Efficiency	Işık Açısı Beam Angle	Işık Kaynağı Light Source	CRI	Ø (mm)	CUT (mm)	H (mm)
21330	3W	250Lm	85Lm/W	10°/20°/36°/60°	LED	80	52	40	31



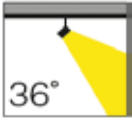

ÜRÜN ÖZELLİKLERİ/PRODUCT SPECIFICATIONS

Ürün Tanımı	Sıva Altı Spot	Product Description	Recessed Downlight
Gövde	Alüminyum	Body	Aluminum Housing
Boya		Paint	
PCB		PCB	
Lens		Lens	
Reflektör		Reflector	
Difüzör		Diffuser	
SDCM (MacAdam)	3	SDCM (MacAdam)	3
Renk Sıcaklığı	2700K/3000K/4000K	Colour Temperature	2700K/3000K/4000K
Ömür	50000h	Life Time	50000h
Çalışma Sıcaklığı	25°C	Operating Temperature	25°C
LED	Epistar	LED	Epistar
Sürücü		Driver	
Uygunluk	EN 60598-1 EN 60598-2-2	Conformity	EN 60598-1 EN 60598-2-2

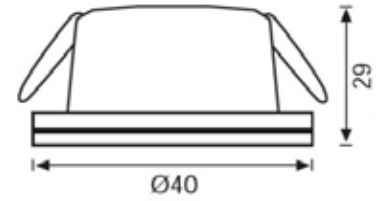

Ürün Kodu Product Code	Güç Power	Çıkış Işık Akısı Lumen Output	Verimlilik Efficiency	Işık Açısı Beam Angle	Işık Kaynağı Light Source	CRI	Ø (mm)	CUT (mm)	H (mm)
21316	3W	150Lm	50Lm/W	36°	LED	80	40	32	29





ÜRÜN ÖZELLİKLERİ/PRODUCT SPECIFICATIONS

Ürün Tanımı	Sıva Altı Hareketli Spot	Product Description	Recessed Downlight
Gövde	Alüminyum Enjeksiyon	Body	Die-Cast Aluminum
Boya	Elektrostatik Toz Boya	Paint	Electrostatic Powder Coated
PCB		PCB	
Lens		Lens	
Reflektör		Reflector	
Difüzör	Şeffaf	Diffuser	Transparent
SDCM (MacAdam)	3	SDCM (MacAdam)	3
Renk Sıcaklığı	2700K/6500K	Colour Temperature	2700K/6500K
Ömür	50000h	Life Time	50000h
Çalışma Sıcaklığı	25°C	Operating Temperature	25°C
LED	Samsung	LED	Samsung
Sürücü		Driver	
Uygunluk	EN 60598-1 EN 60598-2-2	Conformity	EN 60598-1 EN 60598-2-2

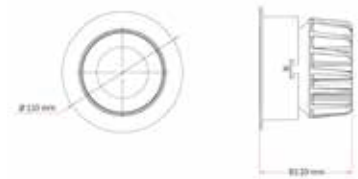

Ürün Kodu Product Code	Güç Power	Çıkış Işık Akısı Lumen Output	Verimlilik Efficiency	Işık Açısı Beam Angle	Işık Kaynağı Light Source	CRI	Ø (mm)	CUT (mm)	H (mm)
21326	4,8W	350Lm	73Lm/W	12°/24°/36°	LED	80	110	95	70
21327	12W	1885Lm	128Lm/W	12°/24°/36°	LED	80	110	95	70
21328	20W	2620Lm	130Lm/W	12°/24°/36°	LED	80	110	95	85



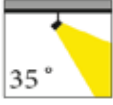

ÜRÜN ÖZELLİKLERİ/PRODUCT SPECIFICATIONS

Ürün Tanımı	Sıva Altı Hareketli Spot	Product Description	Recessed Adjustable Downlight
Gövde	Metal & Plastik	Body	Metal & Plastic
Boya		Paint	
PCB		PCB	
Lens		Lens	
Reflektör		Reflector	
Difüzör		Diffuser	
SDCM (MacAdam)	3	SDCM (MacAdam)	3
Renk Sıcaklığı	2700K/3000K/4000K	Colour Temperature	2700K/3000K/4000K
Ömür	50000h	Life Time	50000h
Çalışma Sıcaklığı	25°C	Operating Temperature	25°C
LED		LED	
Sürücü		Driver	
Uygunluk	EN 60598-1 EN 60598-2-2	Conformity	EN 60598-1 EN 60598-2-2

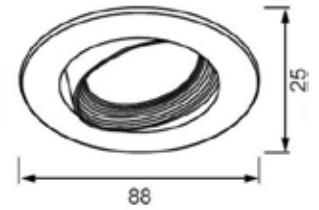

Ürün Kodu Product Code	Güç Power	Çıkış Işık Akısı Lumen Output	Verimlilik Efficiency	Işık Açısı Beam Angle	Işık Kaynağı Light Source	CRI	Ø (mm)	CUT (mm)	H (mm)
21081	5W	350Lm	70Lm/W	35°	GU10	80	88	70	25



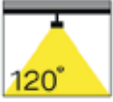

ÜRÜN ÖZELLİKLERİ/PRODUCT SPECIFICATIONS

Ürün Tanımı	Sıva Altı Spot	Product Descripton	Recessed Downlight
Gövde	Plastik	Body	Plastic
Boya		Paint	
PCB		PCB	
Lens		Lens	
Reflektör		Reflector	
Difüzör		Diffuser	
SDCM (MacAdam)	3	SDCM (MacAdam)	3
Renk Sıcaklığı	3000K	Colour Temperature	3000K
Ömür	50000h	Life Time	50000h
Çalışma Sıcaklığı	25°C	Operating Temperature	25°C
LED		LED	
Sürücü		Driver	
Uygunluk	EN 60598-1 EN 60598-2-2	Conformity	EN 60598-1 EN 60598-2-2

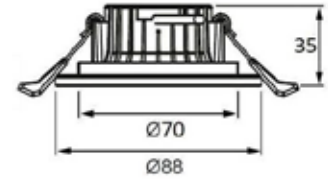

Ürün Kodu Product Code	Güç Power	Çıkış Işık Akısı Lumen Output	Verimlilik Efficiency	Işık Açısı Beam Angle	Işık Kaynağı Light Source	CRI	Ø (mm)	CUT (mm)	H (mm)
21095	5W	400Lm	80Lm/W	120°	LED	80	88	70	35



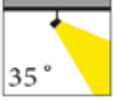

ÜRÜN ÖZELLİKLERİ/PRODUCT SPECIFICATIONS

Ürün Tanımı	Sıva Altı Spot	Product Description	Recessed Downlight
Gövde	Alüminyum Enjeksiyon	Body	Die-Cast Aluminum Housing
Boya	Kaplama	Paint	Plated
PCB		PCB	
Lens		Lens	
Reflektör		Reflector	
Difüzör		Diffuser	
SDCM (MacAdam)	3	SDCM (MacAdam)	3
Renk Sıcaklığı	3000K	Colour Temperature	3000K
Ömür	50000h	Life Time	50000h
Çalışma Sıcaklığı	25°C	Operating Temperature	25°C
LED		LED	
Sürücü		Driver	
Uygunluk	EN 60598-1 EN 60598-2-2	Conformity	EN 60598-1 EN 60598-2-2

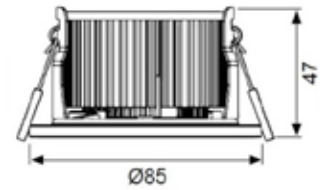

Ürün Kodu Product Code	Güç Power	Çıkış Işık Akısı Lumen Output	Verimlilik Efficiency	Işık Açısı Beam Angle	Işık Kaynağı Light Source	CRI	Ø (mm)	CUT (mm)	H (mm)
21093	6W	480lm	80lm/W	35°	LED	80	85	75	47



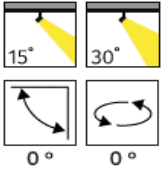

ÜRÜN ÖZELLİKLERİ/PRODUCT SPECIFICATIONS

Ürün Tanımı	Sıva Altı Spot	Product Description	Recessed Downlight
Gövde	Alüminyum Enjeksiyon	Body	Die-Cast Aluminum
Boya	Elektrostatik Toz Boya	Paint	Electrostatic Powder Coated
PCB		PCB	
Lens		Lens	
Reflektör	Yüksek Safılıkta Alüminyum	Reflector	High Purity Aluminum
Difüzör	Temperli Cam	Diffuser	Tempered Glass
SDCM (MacAdam)	3	SDCM (MacAdam)	3
Renk Sıcaklığı	2700K/3000K/4000K	Colour Temperature	2700K/3000K/4000K
Ömür	50000h	Life Time	50000h
Çalışma Sıcaklığı	25°C	Operating Temperature	25°C
LED	Osram/Tridonic/Nichia/ Samsung/Cree	LED	Osram/Tridonic/Nichia/ Samsung/Cree
Sürücü	Tridonic	Driver	Tridonic
Uygunluk	EN 60598-1 EN 60598-2-2	Conformity	EN 60598-1 EN 60598-2-2

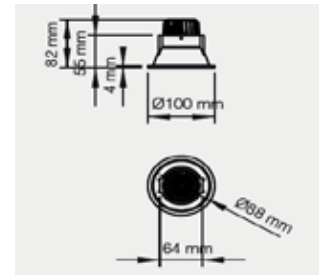

Ürün Kodu Product Code	Güç Power	Çıkış Işık Akısı Lumen Output	Verimlilik Efficiency	Işık Açısı Beam Angle	Işık Kaynağı Light Source	CRI	Ø (mm)	CUT (mm)	H (mm)
21136	8W	654Lm	81Lm/W	15°/30°	LED	80	100	90	82
21137	5W	350Lm	70Lm/W	35°	GU10	80	100	90	82





ÜRÜN ÖZELLİKLERİ/PRODUCT SPECIFICATIONS

Ürün Tanımı	Sıva Altı Spot	Product Description	Recessed Downlight
Gövde	Alüminyum Enjeksiyon	Body	Die-Cast Aluminum
Boya	Elektrostatik Toz Boya	Paint	Electrostatic Powder Coated
PCB		PCB	
Lens		Lens	
Reflektör	Yüksek Safılıkta Alüminyum	Reflector	High Purity Aluminum
Difüzör	Temperli Cam	Diffuser	Tempered Glass
SDCM (MacAdam)	3	SDCM (MacAdam)	3
Renk Sıcaklığı	2700K/3000K/4000K	Colour Temperature	2700K/3000K/4000K
Ömür	50000h	Life Time	50000h
Çalışma Sıcaklığı	25°C	Operating Temperature	25°C
LED	Osram/Tridonic/Nichia/ Samsung/Cree	LED	Osram/Tridonic/Nichia/ Samsung/Cree
Sürücü	Tridonic	Driver	Tridonic
Uygunluk	EN 60598-1 EN 60598-2-2	Conformity	EN 60598-1 EN 60598-2-2

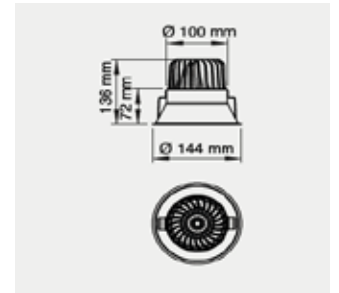

Ürün Kodu Product Code	Güç Power	Çıkış Işık Akısı Lumen Output	Verimlilik Efficiency	Işık Açısı Beam Angle	Işık Kaynağı Light Source	CRI	Ø (mm)	CUT (mm)	H (mm)
21403	20W	1774Lm	89Lm/W	15°/30°/45°/60°	LED	80	144	135	136
21404	30W	2938Lm	93Lm/W	15°/30°/45°/60°	LED	80	144	135	136
21405	35W	3255Lm	93Lm/W	15°/30°/45°/60°	LED	80	144	135	136





ÜRÜN ÖZELLİKLERİ/PRODUCT SPECIFICATIONS

Ürün Tanımı	Sıva Altı Spot	Product Description	Recessed Downlight
Gövde	Alüminyum Enjeksiyon	Body	Die-Cast Aluminum
Boya	Elektrostatik Toz Boya	Paint	Electrostatic Powder Coated
PCB		PCB	
Lens		Lens	
Reflektör	Yüksek Safılıkta Alüminyum	Reflector	High Purity Aluminum
Difüzör	Temperli Cam	Diffuser	Tempered Glass
SDCM (MacAdam)	3	SDCM (MacAdam)	3
Renk Sıcaklığı	2700K/3000K/4000K	Colour Temperature	2700K/3000K/4000K
Ömür	50000h	Life Time	50000h
Çalışma Sıcaklığı	25°C	Operating Temperature	25°C
LED	Osram/Tridonic/Nichia/ Samsung/Cree	LED	Osram/Tridonic/Nichia/ Samsung/Cree
Sürücü		Driver	
Uygunluk	EN 60598-1 EN 60598-2-2	Conformity	EN 60598-1 EN 60598-2-2

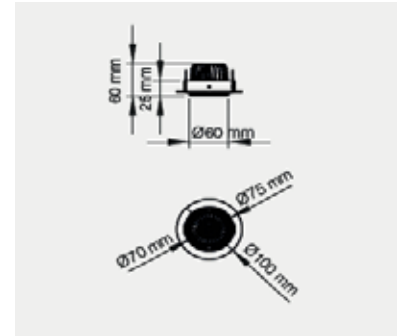

Ürün Kodu Product Code	Güç Power	Çıkış Işık Akısı Lumen Output	Verimlilik Efficiency	Işık Açısı Beam Angle	Işık Kaynağı Light Source	CRI	Ø (mm)	CUT (mm)	H (mm)
21128	8W	654Lm	81Lm/W	15°/30°/45°	LED	80	100	100	60
21129	5W	350Lm	70Lm/W	35°	GU10	80	100	100	60





ÜRÜN ÖZELLİKLERİ/PRODUCT SPECIFICATIONS

Ürün Tanımı	Trimless Spot	Product Description	Trimless Downlight
Gövde	Alüminyum Ekstrüzyon	Body	Aluminum Extrusion
Boya	Elektrostatik Toz Boya	Paint	Electrostatic Powder Coated
PCB		PCB	
Lens		Lens	
Reflektör		Reflector	
Difüzör	Polikarbon Cam	Diffuser	Polycarbonate Glass
SDCM (MacAdam)	3	SDCM (MacAdam)	3
Renk Sıcaklığı	2700K/6500K	Colour Temperature	2700K/6500K
Ömür	50000h	Life Time	50000h
Çalışma Sıcaklığı	25°C	Operating Temperature	25°C
LED	Samsung	LED	Samsung
Sürücü		Driver	
Uygunluk	EN 60598-1 EN 60598-2-2	Conformity	EN 60598-1 EN 60598-2-2

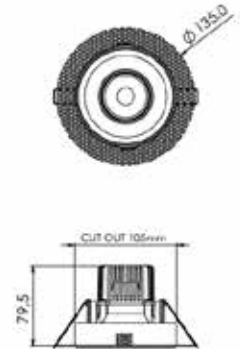

Ürün Kodu Product Code	Güç Power	Çıkış Işık Akısı Lumen Output	Verimlilik Efficiency	Işık Açısı Beam Angle	Işık Kaynağı Light Source	CRI	Ø (mm)	CUT (mm)	H (mm)
21345	7W	896Lm	128Lm/W	24°/36°	LED	80	135	105	79,5
21346	14W	1792Lm	128Lm/W	24°/36°	LED	80	135	105	79,5



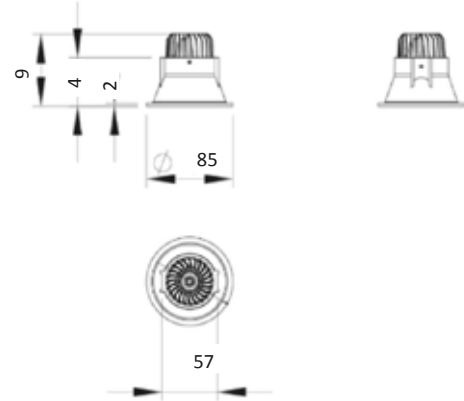

ÜRÜN ÖZELLİKLERİ/PRODUCT SPECIFICATIONS

Ürün Tanımı	Sıva Altı Spot	Product Description	Recessed Spot
Gövde	Alüminyum Gövde	Body	Aluminum Housing
Boya	Elektrostatik Toz Boya	Paint	Elektrostatik Powder Coated
PCB		PCB	
Lens		Lens	
Reflektör	Alüminyum	Reflector	Aluminium
Difüzör		Diffuser	
SDCM (MacAdam)	3	SDCM (MacAdam)	3
Renk Sıcaklığı	3000K/4000K	Colour Temperature	3000K/4000K
Ömür	50000h	Life Time	50000h
Çalışma Sıcaklığı	25°C	Operating Temperature	25°C
LED	Tridonic	LED	Tridonic
Sürücü		Driver	
Uygunluk	EN 60598-1 EN 60598-2-1	Conformity	EN 60598-1 EN 60598-2-1

Ürün Kodu Product Code	Güç Power	Çıkış Işık Akısı Lumen Output	Verimlilik Efficiency	Işık Açısı Beam Angle	Işık Kaynağı Light Source	CRI	Ø (mm)	CUT (mm)	H (mm)
21166	5W	350Lm	100Lm/W	35°	GU10	80	85	75	90
21167	8W	654Lm	81Lm/W	15°/30°/45°/60°	LED	80	85	75	90
21204	10W	810Lm	81Lm/W	15°/30°/45°/60°	LED	80	85	75	90
21205	12W	1400Lm	116Lm/W	15°/30°/45°/60°	LED	80	85	75	120



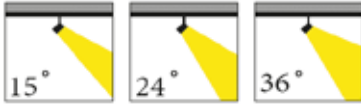

ÜRÜN ÖZELLİKLERİ/PRODUCT SPECIFICATIONS

Ürün Tanımı	Sıva Altı Spot	Product Description	Recessed Downlight
Gövde	Alüminyum Enjeksiyon	Body	Die-Cast Aluminum
Boya	Elektrostatik Toz Boya	Paint	Electrostatic Powder Coated
PCB		PCB	
Lens		Lens	
Reflektör		Reflector	
Difüzör	Polikarbon Cam	Diffuser	Polycarbonate Glass
SDCM (MacAdam)	3	SDCM (MacAdam)	3
Renk Sıcaklığı	2700K/6500K	Colour Temperature	2700K/6500K
Ömür	50000h	Life Time	50000h
Çalışma Sıcaklığı	25°C	Operating Temperature	25°C
LED	Samsung	LED	Samsung
Sürücü		Driver	
Uygunluk	EN 60598-1 EN 60598-2-2	Conformity	EN 60598-1 EN 60598-2-2

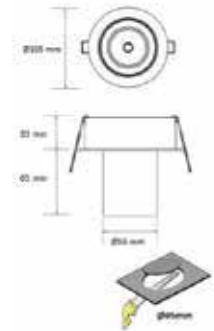

Ürün Kodu Product Code	Güç Power	Çıkış Işık Akısı Lumen Output	Verimlilik Efficiency	Işık Açısı Beam Angle	Işık Kaynağı Light Source	CRI	Ø (mm)	CUT (mm)	H (mm)
21336	7W	770Lm	110Lm/W	15°/24°/36°	LED	80	105	95	65
21337	9W	990Lm	110Lm/W	15°/24°/36°	LED	80	105	95	65
21338	14W	1540Lm	110Lm/W	15°/24°/36°	LED	80	105	95	65



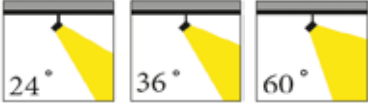

ÜRÜN ÖZELLİKLERİ/PRODUCT SPECIFICATIONS

Ürün Tanımı	Sıva Altı Spot	Product Description	Recessed Downlight
Gövde	Alüminyum Ekstrüzyon	Body	Aluminum Extrusion
Boya	Elektrostatik Toz Boya	Paint	Electrostatic Powder Coated
PCB		PCB	
Lens	PC	Lens	PC
Reflektör		Reflector	
Difüzör	Şeffaf	Diffuser	Transparent
SDCM (MacAdam)	3	SDCM (MacAdam)	3
Renk Sıcaklığı	2700K/6500K	Colour Temperature	2700K/6500K
Ömür	50000h	Life Time	50000h
Çalışma Sıcaklığı	25°C	Operating Temperature	25°C
LED	Samsung	LED	Samsung
Sürücü		Driver	
Uygunluk	EN 60598-1 EN 60598-2-2	Conformity	EN 60598-1 EN 60598-2-2

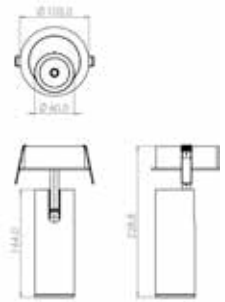

Ürün Kodu Product Code	Güç Power	Çıkış Işık Akısı Lumen Output	Verimlilik Efficiency	Işık Açısı Beam Angle	Işık Kaynağı Light Source	CRI	Ø (mm)	H (mm)
25113	8W	1100lm	128lm/W	24°/36°	LED	80	60	164
25114	10W	1280lm	128lm/W	24°/36°	LED	80	105	150
25115	20W	2480lm	124lm/W	24°/36°/60°	LED	80	105	206



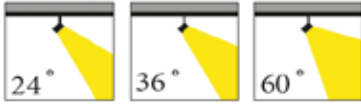

ÜRÜN ÖZELLİKLERİ/PRODUCT SPECIFICATIONS

Ürün Tanımı	Sıva Altı Spot	Product Description	Recessed Downlight
Gövde	Alüminyum Enjeksiyon	Body	Die-Cast Aluminum
Boya	Elektrostatik Toz Boya	Paint	Electrostatic Powder Coated
PCB		PCB	
Lens		Lens	
Reflektör		Reflector	
Difüzör	Polikarbon Cam	Diffuser	Polycarbonate Glass
SDCM (MacAdam)	3	SDCM (MacAdam)	3
Renk Sıcaklığı	2700K/6500K	Colour Temperature	2700K/6500K
Ömür	50000h	Life Time	50000h
Çalışma Sıcaklığı	25°C	Operating Temperature	25°C
LED	Samsung	LED	Samsung
Sürücü		Driver	
Uygunluk	EN 60598-1 EN 60598-2-2	Conformity	EN 60598-1 EN 60598-2-2

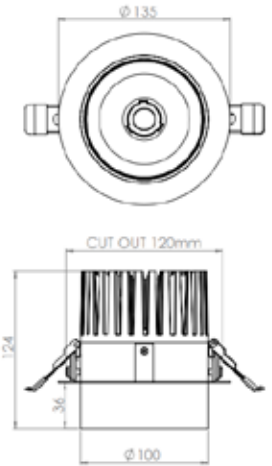

Ürün Kodu Product Code	Güç Power	Çıkış Işık Akısı Lumen Output	Verimlilik Efficiency	Işık Açısı Beam Angle	Işık Kaynağı Light Source	CRI	Ø (mm)	CUT (mm)	H (mm)
21334	20W	2480lm	124lm/W	24°/36°/60°	LED	80	135	120	124
21335	28W	3472lm	124lm/W	24°/36°/60°	LED	80	135	120	124





ÜRÜN ÖZELLİKLERİ/PRODUCT SPECIFICATIONS

Ürün Tanımı	Sıva Altı Spot	Product Description	Recessed Downlight
Gövde	Alüminyum Enjeksiyon	Body	Die-Cast Aluminum
Boya	Elektrostatik Toz Boya	Paint	Elektrostatic Powder Coated
PCB		PCB	
Lens		Lens	
Reflektör	Yüksek Safılıkta Alüminyum	Reflector	High Purity Aluminum
Difüzör	Temperli Cam	Diffuser	Tempered Glass
SDCM (MacAdam)	3	SDCM (MacAdam)	3
Renk Sıcaklığı	2700K/3000K/4000K	Colour Temperature	2700K/3000K/4000K
Ömür	50000h	Life Time	50000h
Çalışma Sıcaklığı	25°C	Operating Temperature	25°C
LED	Osram/Tridonic/Nichia/Samsung/Cree	LED	Osram/Tridonic/Nichia/Samsung/Cree
Sürücü		Driver	
Uygunluk	EN 60598-1 EN 60598-2-2	Conformity	EN 60598-1 EN 60598-2-2

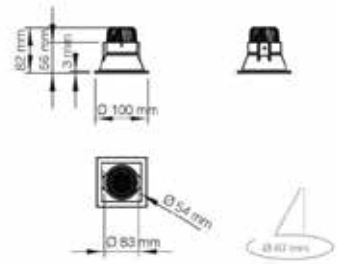

Ürün Kodu Product Code	Güç Power	Çıkış Işık Akısı Lumen Output	Verimlilik Efficiency	Işık Açısı Beam Angle	Işık Kaynağı Light Source	CRI	LxW (mm)	CUT (mm)	H (mm)
21222	8W	654Lm	81Lm/W	15°/30°/45°/60°	LED	80	100x100	87x87	82
21268	5W	350Lm	70Lm/W	35°	GU10	80	100x100	87x87	82



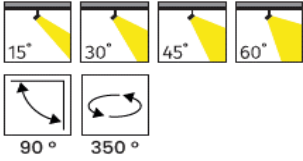

ÜRÜN ÖZELLİKLERİ/PRODUCT SPECIFICATIONS

Ürün Tanımı	Sıva Altı Spot	Product Description	Recessed Downlight
Gövde	Alüminyum Enjeksiyon	Body	Die-Cast Aluminum
Boya	Elektrostatik Toz Boya	Paint	Elektrostatic Powder Coated
PCB		PCB	
Lens		Lens	
Reflektör	Yüksek Safılıkta Alüminyum	Reflector	High Purity Aluminum
Difüzör	Temperli Cam	Diffuser	Tempered Glass
SDCM (MacAdam)	3	SDCM (MacAdam)	3
Renk Sıcaklığı	2700K/3000K/4000K	Colour Temperature	2700K/3000K/4000K
Ömür	50000h	Life Time	50000h
Çalışma Sıcaklığı	25°C	Operating Temperature	25°C
LED	Osram/Samsung	LED	Osram/Samsung
Sürücü		Driver	
Uygunluk	EN 60598-1 EN 60598-2-2	Conformity	EN 60598-1 EN 60598-2-2

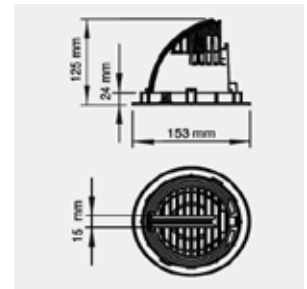

Ürün Kodu Product Code	Güç Power	Çıkış Işık Akısı Lumen Output	Verimlilik Efficiency	Işık Açısı Beam Angle	Işık Kaynağı Light Source	CRI	Ø (mm)	CUT (mm)	H (mm)
21132	8W	654Lm	81Lm/W	15°/30°/45°/60°	LED	80	154	145	125
21133	5W	350Lm	70Lm/W	35°	GU10	80	154	145	125



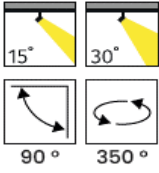

ÜRÜN ÖZELLİKLERİ/PRODUCT SPECIFICATIONS

Ürün Tanımı	Sıva Altı Spot	Product Description	Recessed Downlight
Gövde	Alüminyum Enjeksiyon	Body	Die-Cast Aluminum
Boya	Elektrostatik Toz Boya	Paint	Electrostatic Powder Coated
PCB		PCB	
Lens		Lens	
Reflektör	Yüksek Safılıkta Alüminyum	Reflector	High Purity Aluminum
Difüzör	Temperli Cam	Diffuser	Tempered Glass
SDCM (MacAdam)	3	SDCM (MacAdam)	3
Renk Sıcaklığı	2700K/3000K/4000K	Colour Temperature	2700K/3000K/4000K
Ömür	50000h	Life Time	50000h
Çalışma Sıcaklığı	25°C	Operating Temperature	25°C
LED	Osram/Samsung	LED	Osram/Samsung
Sürücü		Driver	
Uygunluk	EN 60598-1 EN 60598-2-2	Conformity	EN 60598-1 EN 60598-2-2

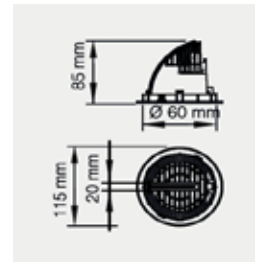

Ürün Kodu Product Code	Güç Power	Çıkış Işık Akısı Lumen Output	Verimlilik Efficiency	Işık Açısı Beam Angle	Işık Kaynağı Light Source	CRI	Ø (mm)	CUT (mm)	H (mm)
21383	8W	587Lm	73Lm/W	15°/30°	LED	80	60	100	85
21384	10W	654Lm	65Lm/W	15°/30°	LED	80	60	100	85



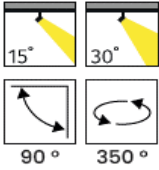

ÜRÜN ÖZELLİKLERİ/PRODUCT SPECIFICATIONS

Ürün Tanımı	Sıva Altı Spot	Product Description	Recessed Downlight
Gövde	Alüminyum Enjeksiyon	Body	Die-Cast Aluminum
Boya	Elektrostatik Toz Boya	Paint	Elektrostatic Powder Coated
PCB		PCB	
Lens		Lens	
Reflektör	Yüksek Safılıkta Alüminyum	Reflector	High Purity Aluminum
Difüzör	Temperli Cam	Diffuser	Tempered Glass
SDCM (MacAdam)	3	SDCM (MacAdam)	3
Renk Sıcaklığı	2700K/3000K/4000K	Colour Temperature	2700K/3000K/4000K
Ömür	50000h	Life Time	50000h
Çalışma Sıcaklığı	25°C	Operating Temperature	25°C
LED	Osram/Samsung	LED	Osram/Samsung
Sürücü		Driver	
Uygunluk	EN 60598-1 EN 60598-2-2	Conformity	EN 60598-1 EN 60598-2-2

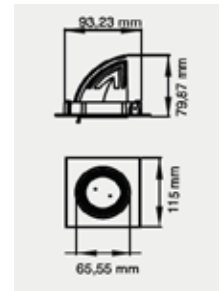

Ürün Kodu Product Code	Güç Power	Çıkış Işık Akısı Lumen Output	Verimlilik Efficiency	Işık Açısı Beam Angle	Işık Kaynağı Light Source	CRI	L (mm)	CUT (mm)	H (mm)
21385	8W	587Lm	73Lm/W	15°/30°	LED	80	115	100	79,87
21386	10W	654Lm	65Lm/W	15°/30°	LED	80	115	100	79,87



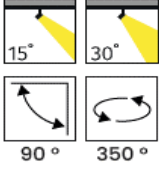

ÜRÜN ÖZELLİKLERİ/PRODUCT SPECIFICATIONS

Ürün Tanımı	Sıva Altı Spot	Product Description	Recessed Downlight
Gövde	Alüminyum Enjeksiyon	Body	Die-Cast Aluminum
Boya	Elektrostatik Toz Boya	Paint	Elektrostatic Powder Coated
PCB		PCB	
Lens		Lens	
Reflektör	Yüksek Safılıkta Alüminyum	Reflector	High Purity Aluminum
Difüzör	Temperli Cam	Diffuser	Tempered Glass
SDCM (MacAdam)	3	SDCM (MacAdam)	3
Renk Sıcaklığı	2700K/3000K/4000K	Colour Temperature	2700K/3000K/4000K
Ömür	50000h	Life Time	50000h
Çalışma Sıcaklığı	25°C	Operating Temperature	25°C
LED	Osram/Samsung	LED	Osram/Samsung
Sürücü		Driver	
Uygunluk	EN 60598-1 EN 60598-2-2	Conformity	EN 60598-1 EN 60598-2-2

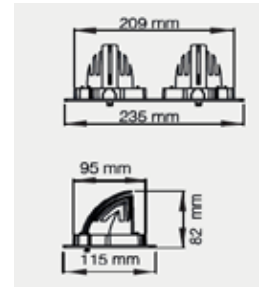

Ürün Kodu Product Code	Güç Power	Çıkış Işık Akısı Lumen Output	Verimlilik Efficiency	Işık Açısı Beam Angle	Işık Kaynağı Light Source	CRI	L (mm)	CUT (mm)	H (mm)
23061	15W	1242Lm	82Lm/W	15°/30°	LED	80	235	220X100	82
23062	20W	1774Lm	88Lm/W	15°/30°	LED	80	235	220X100	82



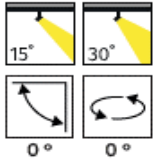

ÜRÜN ÖZELLİKLERİ/PRODUCT SPECIFICATIONS

Ürün Tanımı	Sıva Altı Spot	Product Description	Recessed Downlight
Gövde	Alüminyum Enjeksiyon	Body	Die-Cast Aluminum
Boya	Elektrostatik Toz Boya	Paint	Electrostatic Powder Coated
PCB		PCB	
Lens		Lens	
Reflektör	Yüksek Safılıkta Alüminyum	Reflector	High Purity Aluminum
Difüzör	Temperli Cam	Diffuser	Tempered Glass
SDCM (MacAdam)	3	SDCM (MacAdam)	3
Renk Sıcaklığı	2700K/3000K/4000K	Colour Temperature	2700K/3000K/4000K
Ömür	50000h	Life Time	50000h
Çalışma Sıcaklığı	25°C	Operating Temperature	25°C
LED	Osram/Samsung	LED	Osram/Samsung
Sürücü		Driver	
Uygunluk	EN 60598-1 EN 60598-2-2	Conformity	EN 60598-1 EN 60598-2-2

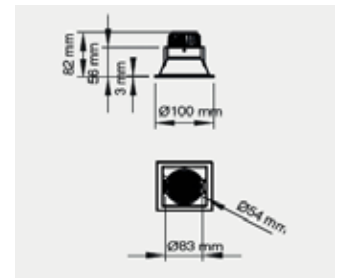

Ürün Kodu Product Code	Güç Power	Çıkış Işık Akısı Lumen Output	Verimlilik Efficiency	Işık Açısı Beam Angle	Işık Kaynağı Light Source	CRI	LxW (mm)	CUT (mm)	H (mm)
21296	5W	460Lm	70Lm/W	35°	GU10	80	100x100	90X90	83
21297	8W	670Lm	81Lm/W	35°	GU10	80	100x100	90X90	83
21298	8W	587Lm	73Lm/W	15°/30°	LED	80	100x100	90X90	83
21299	10W	654Lm	65Lm/W	15°/30°	LED	80	100x100	90X90	83





ÜRÜN ÖZELLİKLERİ/PRODUCT SPECIFICATIONS

Ürün Tanımı	Sıva Altı Spot	Product Description	Recessed Downlight
Gövde	Alüminyum Enjeksiyon	Body	Die-Cast Aluminum
Boya	Elektrostatik Toz Boya	Paint	Elektrostatic Powder Coated
PCB		PCB	
Lens		Lens	
Reflektör	Yüksek Safılıkta Alüminyum	Reflector	High Purity Aluminum
Difüzör		Diffuser	
SDCM (MacAdam)	3	SDCM (MacAdam)	3
Renk Sıcaklığı	2700K/3000K/4000K	Colour Temperature	2700K/3000K/4000K
Ömür	50000h	Life Time	50000h
Çalışma Sıcaklığı	25°C	Operating Temperature	25°C
LED	Osram/Samsung	LED	Osram/Samsung
Sürücü		Driver	
Uygunluk	EN 60598-1 EN 60598-2-2	Conformity	EN 60598-1 EN 60598-2-2

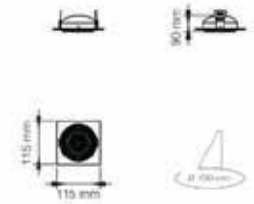

Ürün Kodu Product Code	Güç Power	Çıkış Işık Akısı Lumen Output	Verimlilik Efficiency	Işık Açısı Beam Angle	Işık Kaynağı Light Source	CRI	LxW (mm)	CUT (mm)	H (mm)
21293	5W	460Lm	92Lm/W	35°	GU10	80	115x115	100x100	90
21294	8W	587Lm	73Lm/W	15°/30°/45°/60°	LED	80	115x115	100x100	90
21295	10W	654Lm	65Lm/W	15°/30°/45°/60°	LED	80	115x115	100x100	90



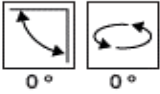
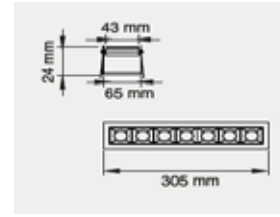
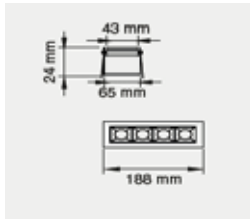
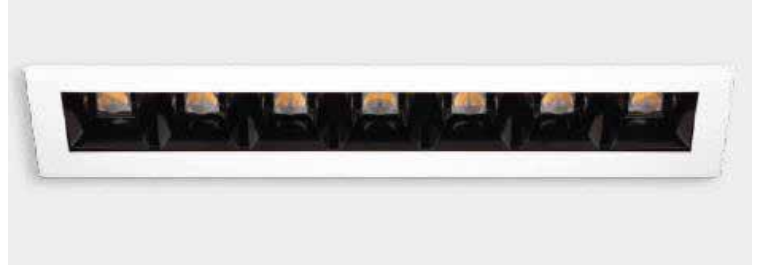

ÜRÜN ÖZELLİKLERİ/PRODUCT SPECIFICATIONS

Ürün Tanımı	Sıva Altı Spot	Product Description	Recessed Spotlights
Gövde	Alüminyum Enjeksiyon	Body	Die-Cast Aluminum Housing
Boya	Elektrostatik Toz Boya	Paint	Electrostatic Powder Coated
PCB		PCB	
Lens		Lens	
Reflektör		Reflector	
SDCM (MacAdam)	3	SDCM (MacAdam)	3
Renk Sıcaklığı	2700K/3000K/4000K	Colour Temperature	2700K/3000K/4000K
Ömür	50000h	Life Time	50000h
Çalışma Sıcaklığı	25°C	Operating Temperature	25°C
LED	Osram/Samsung	LED	Osram/Samsung
Sürücü		Driver	
Uygunluk	EN 60598-1 EN 60598-2-2	Conformity	EN 60598-1 EN 60598-2-2

Ürün Kodu Product Code	Güç Power	Çıkış Işık Akısı Lumen Output	Verimlilik Efficiency	Işık Açısı Beam Angle	Işık Kaynağı Light Source	CRI	LxW (mm)	CUT (mm)	H (mm)
21387	5,93W	1040Lm	88Lm/W		LED	80	188X43	50X175	24
21388	11,2W	1820Lm	88Lm/W		LED	80	305x43	50X290	24



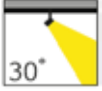
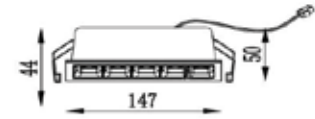
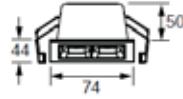
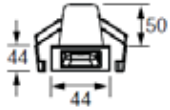

ÜRÜN ÖZELLİKLERİ/PRODUCT SPECIFICATIONS

Ürün Tanımı	Sıva Altı Spot	Product Description	Recessed Spotlights
Gövde	Alüminyum Enjeksiyon	Body	Die-Cast Aluminum Housing
Boya	Elektrostatik Toz Boya	Paint	Elektrostatic Powder Coated
PCB		PCB	
Lens		Lens	
Reflektör	Siyah Plastik	Reflector	Plastic In Black Colour
SDCM (MacAdam)	3	SDCM (MacAdam)	3
Renk Sıcaklığı	3000K	Colour Temperature	3000K
Ömür	50000h	Life Time	50000h
Çalışma Sıcaklığı	25°C	Operating Temperature	25°C
LED	Cree	LED	Cree
Sürücü		Driver	
Uygunluk	EN 60598-1 EN 60598-2-2	Conformity	EN 60598-1 EN 60598-2-2

Ürün Kodu Product Code	Güç Power	Çıkış Işık Akısı Lumen Output	Verimlilik Efficiency	Işık Açısı Beam Angle	Işık Kaynağı Light Source	CRI	LxW (mm)	CUT (mm)	H (mm)
21147	2W	150Lm	75Lm/W	30°	LED	80	44x44	33x33	50
21170	2x2W	2x150Lm	75Lm/W	30°	LED	80	74x44	63x33	50
21169	5x2W	5x150Lm	75Lm/W	30°	LED	80	147x44	136x33	50



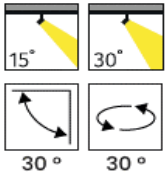

ÜRÜN ÖZELLİKLERİ/PRODUCT SPECIFICATIONS

Ürün Tanımı	Sıva Altı Spot	Product Description	Recessed Downlight
Gövde	Alüminyum Enjeksiyon	Body	Die-Cast Aluminum
Boya	Elektrostatik Toz Boya	Paint	Elektrostatic Powder Coated
PCB		PCB	
Lens		Lens	
Reflektör	Yüksek Safılıkta Alüminyum	Reflector	High Purity Aluminum
Difüzör	Temperli Cam	Diffuser	Tempered Glass
SDCM (MacAdam)	3	SDCM (MacAdam)	3
Renk Sıcaklığı	2700K/3000K/4000K	Colour Temperature	2700K/3000K/4000K
Ömür	50000h	Life Time	50000h
Çalışma Sıcaklığı	25°C	Operating Temperature	25°C
LED	Osram/Samsung	LED	Osram/Samsung
Sürücü		Driver	
Uygunluk	EN 60598-1 EN 60598-2-2	Conformity	EN 60598-1 EN 60598-2-2

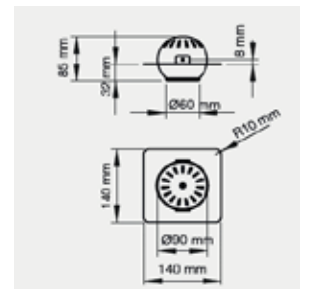

Ürün Kodu Product Code	Güç Power	Çıkış Işık Akısı Lumen Output	Verimlilik Efficiency	Işık Açısı Beam Angle	Işık Kaynağı Light Source	CRI	LxW (mm)	CUT (mm)	H (mm)
21130	8W	654Lm	81Lm/W	15°/30°	LED	80	140x140	120x120	85
21131	5W	350Lm	70Lm/W	35°	GU10	80	140x140	120x120	85



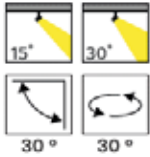

ÜRÜN ÖZELLİKLERİ/PRODUCT SPECIFICATIONS

Ürün Tanımı	Sıva Altı Spot	Product Description	Recessed Downlight
Gövde	Alüminyum Enjeksiyon	Body	Die-Cast Aluminum
Boya	Elektrostatik Toz Boya	Paint	Elektrostatic Powder Coated
PCB		PCB	
Lens		Lens	
Reflektör	Yüksek Saflıkta Alüminyum	Reflector	High Purity Aluminum
Difüzör	Temperli Cam	Diffuser	Tempered Glass
SDCM (MacAdam)	3	SDCM (MacAdam)	3
Renk Sıcaklığı	2700K/3000K/4000K	Colour Temperature	2700K/3000K/4000K
Ömür	50000h	Life Time	50000h
Çalışma Sıcaklığı	25°C	Operating Temperature	25°C
LED	Osram/Samsung	LED	Osram/Samsung
Sürücü		Driver	
Uygunluk	EN 60598-1 EN 60598-2-2	Conformity	EN 60598-1 EN 60598-2-2

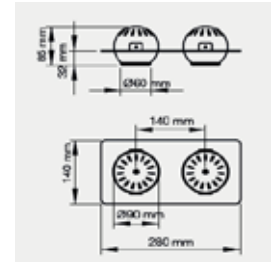

Ürün Kodu Product Code	Güç Power	Çıkış Işık Akısı Lumen Output	Verimlilik Efficiency	Işık Açısı Beam Angle	Işık Kaynağı Light Source	CRI	LxW (mm)	CUT (mm)	H (mm)
23029	2x8W	2x654Lm	81Lm/W	15°/30°	LED	80	280x140	250x120	85
23030	2x5W	2x350Lm	70Lm/W	35°	GU10	80	280x140	250x120	85



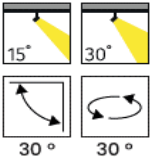

ÜRÜN ÖZELLİKLERİ/PRODUCT SPECIFICATIONS

Ürün Tanımı	Sıva Altı Spot	Product Descripton	Recessed Downlight
Gövde	Alüminyum Enjeksiyon	Body	Die-Cast Aluminum
Boya	Elektrostatik Toz Boya	Paint	Elektrostatic Powder Coated
PCB		PCB	
Lens		Lens	
Reflektör	Yüksek Saflıkta Alüminyum	Reflector	High Purity Aluminum
Difüzör	Temperli Cam	Diffuser	Tempered Glass
SDCM (MacAdam)	3	SDCM (MacAdam)	3
Renk Sıcaklığı	2700K/3000K/4000K	Colour Temperature	2700K/3000K/4000K
Ömür	50000h	Life Time	50000h
Çalışma Sıcaklığı	25°C	Operating Temperature	25°C
LED	Osram/Samsung	LED	Osram/Samsung
Sürücü		Driver	
Uygunluk	EN 60598-1 EN 60598-2-2	Conformity	EN 60598-1 EN 60598-2-2

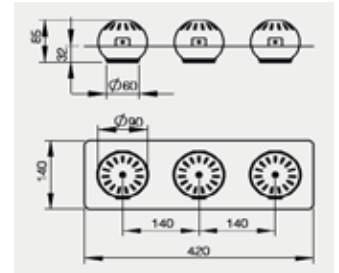

Ürün Kodu Product Code	Güç Power	Çıkış Işık Akısı Lumen Output	Verimlilik Efficiency	Işık Açısı Beam Angle	Işık Kaynağı Light Source	CRI	LxW (mm)	CUT (mm)	H (mm)
24024	3x8W	3x654Lm	81Lm/W	15°/30°	LED	80	420x140	390x120	85
24025	3x5W	3x350Lm	70Lm/W	35°	GU10	80	420x140	390x120	85



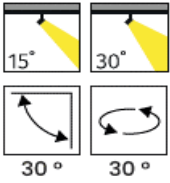

ÜRÜN ÖZELLİKLERİ/PRODUCT SPECIFICATIONS

Ürün Tanımı	Sıva Altı Spot	Product Description	Recessed Downlight
Gövde	Alüminyum Enjeksiyon	Body	Die-Cast Aluminum
Boya	Elektrostatik Toz Boya	Paint	Elektrostatic Powder Coated
PCB		PCB	
Lens		Lens	
Reflektör	Yüksek Safılıkta Alüminyum	Reflector	High Purity Aluminum
Difüzör	Temperli Cam	Diffuser	Tempered Glass
SDCM (MacAdam)	3	SDCM (MacAdam)	3
Renk Sıcaklığı	2700K/3000K/4000K	Colour Temperature	2700K/3000K/4000K
Ömür	50000h	Life Time	50000h
Çalışma Sıcaklığı	25°C	Operating Temperature	25°C
LED	Osram/Samsung	LED	Osram/Samsung
Sürücü		Driver	
Uygunluk	EN 60598-1 EN 60598-2-2	Conformity	EN 60598-1 EN 60598-2-2

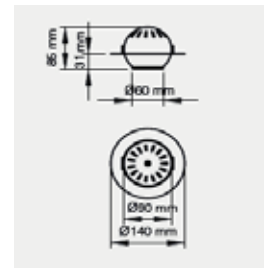

Ürün Kodu Product Code	Güç Power	Çıkış Işık Akısı Lumen Output	Verimlilik Efficiency	Işık Açısı Beam Angle	Işık Kaynağı Light Source	CRI	Ø (mm)	CUT (mm)	H (mm)
21134	8W	654Lm	81Lm/W	15°/30°/45°/60°	LED	80	140	120	85
21135	5W	350Lm	70Lm/W	35°	GU10	80	140	120	85





ÜRÜN ÖZELLİKLERİ/PRODUCT SPECIFICATIONS

Ürün Tanımı	Sıva Altı Spot	Product Description	Recessed Downlight
Gövde	Alüminyum Enjeksiyon	Body	Die-Cast Aluminum
Boya	Elektrostatik Toz Boya	Paint	Electrostatic Powder Coated
PCB		PCB	
Lens		Lens	
Reflektör	Yüksek Safılıkta Alüminyum	Reflector	High Purity Aluminum
Difüzör	Temperli Cam	Diffuser	Tempered Glass
SDCM (MacAdam)	3	SDCM (MacAdam)	3
Renk Sıcaklığı	2700K/3000K/4000K	Colour Temperature	2700K/3000K/4000K
Ömür	50000h	Life Time	50000h
Çalışma Sıcaklığı	25°C	Operating Temperature	25°C
LED	Osram/Samsung	LED	Osram/Samsung
Sürücü		Driver	
Uygunluk	EN 60598-1 EN 60598-2-2	Conformity	EN 60598-1 EN 60598-2-2

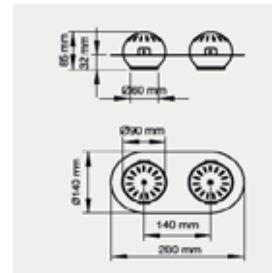

Ürün Kodu Product Code	Güç Power	Çıkış Işık Akısı Lumen Output	Verimlilik Efficiency	Işık Açısı Beam Angle	Işık Kaynağı Light Source	CRI	LxW (mm)	CUT (mm)	H (mm)
23031	2x8W	2x654Lm	81Lm/W	15°/30°/45°/60°	LED	80	280x140	250x120	85
23032	2x5W	2x350Lm	70Lm/W	35°	GU10	80	280x140	250x120	85



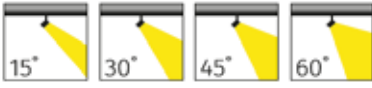

ÜRÜN ÖZELLİKLERİ/PRODUCT SPECIFICATIONS

Ürün Tanımı	Sıva Altı Spot	Product Descripton	Recessed Downlight
Gövde	Alüminyum Enjeksiyon	Body	Die-Cast Aluminum
Boya	Elektrostatik Toz Boya	Paint	Electrostatic Powder Coated
PCB		PCB	
Lens		Lens	
Reflektör	Yüksek Safılıkta Alüminyum	Reflector	High Purity Aluminum
Difüzör	Temperli Cam	Diffuser	Tempered Glass
SDCM (MacAdam)	3	SDCM (MacAdam)	3
Renk Sıcaklığı	2700K/3000K/4000K	Colour Temperature	2700K/3000K/4000K
Ömür	50000h	Life Time	50000h
Çalışma Sıcaklığı	25°C	Operating Temperature	25°C
LED	Osram/Samsung	LED	Osram/Samsung
Sürücü		Driver	
Uygunluk	EN 60598-1 EN 60598-2-2	Conformity	EN 60598-1 EN 60598-2-2

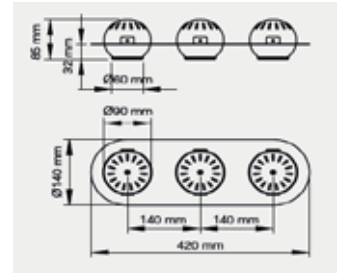

Ürün Kodu Product Code	Güç Power	Çıkış Işık Akısı Lumen Output	Verimlilik Efficiency	Işık Açısı Beam Angle	Işık Kaynağı Light Source	CRI	LxW (mm)	CUT (mm)	H (mm)
24026	3x8W	3x654Lm	81Lm/W	15°/30°/45°/60°	LED	80	420x140	390x120	85
24027	3x5W	3x350Lm	70Lm/W	35°	GU10	80	420x140	390x120	85





ÜRÜN ÖZELLİKLERİ/PRODUCT SPECIFICATIONS

Ürün Tanımı	Sıva Altı Spot	Product Description	Recessed Downlight
Gövde	Alüminyum Enjeksiyon	Body	Die-Cast Aluminum
Boya	Elektrostatik Toz Boya	Paint	Electrostatic Powder Coated
PCB		PCB	
Lens		Lens	
Reflektör	Yüksek Safılıkta Alüminyum	Reflector	High Purity Aluminum
Difüzör	Temperli Cam	Diffuser	Tempered Glass
SDCM (MacAdam)	3	SDCM (MacAdam)	3
Renk Sıcaklığı	2700K/3000K/4000K	Colour Temperature	2700K/3000K/4000K
Ömür	50000h	Life Time	50000h
Çalışma Sıcaklığı	25°C	Operating Temperature	25°C
LED	Osram/Samsung	LED	Osram/Samsung
Sürücü		Driver	
Uygunluk	EN 60598-1 EN 60598-2-2	Conformity	EN 60598-1 EN 60598-2-2

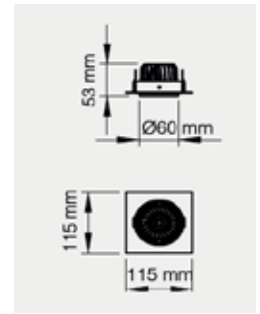

Ürün Kodu Product Code	Güç Power	Çıkış Işık Akısı Lumen Output	Verimlilik Efficiency	Işık Açısı Beam Angle	Işık Kaynağı Light Source	CRI	LxW (mm)	CUT (mm)	H (mm)
70005	5W	350Lm	70Lm/W	35°	GU10	80	115x115	100x100	53
21148	8W	800Lm	100Lm/W	15°/30°/45°/60°	LED	80	115x115	100x100	53
21358	10W	1000Lm	100Lm/W	15°/30°/45°/60°	LED	81	115x115	100x100	53



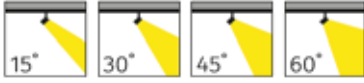

ÜRÜN ÖZELLİKLERİ/PRODUCT SPECIFICATIONS

Ürün Tanımı	Sıva Altı Spot	Product Description	Recessed Downlight
Gövde	Alüminyum Enjeksiyon	Body	Die-Cast Aluminum
Boya	Elektrostatik Toz Boya	Paint	Electrostatic Powder Coated
PCB		PCB	
Lens		Lens	
Reflektör	Yüksek Safılıkta Alüminyum	Reflector	High Purity Aluminum
Difüzör	Temperli Cam	Diffuser	Tempered Glass
SDCM (MacAdam)	3	SDCM (MacAdam)	3
Renk Sıcaklığı	2700K/3000K/4000K	Colour Temperature	2700K/3000K/4000K
Ömür	50000h	Life Time	50000h
Çalışma Sıcaklığı	25°C	Operating Temperature	25°C
LED	Osram/Samsung	LED	Osram/Samsung
Sürücü		Driver	
Uygunluk	EN 60598-1 EN 60598-2-2	Conformity	EN 60598-1 EN 60598-2-2

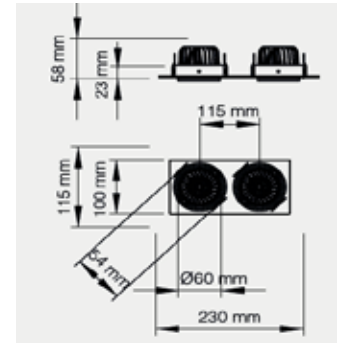

Ürün Kodu Product Code	Güç Power	Çıkış Işık Akısı Lumen Output	Verimlilik Efficiency	Işık Açısı Beam Angle	Işık Kaynağı Light Source	CRI	LxW (mm)	CUT (mm)	H (mm)
23042	2x5W	2x350Lm	70Lm/W	35°	2xGU10	80	230x115	100x215	58
23043	2x8W	2x654Lm	81Lm/W	15°/30°/45°/60°	LED	80	230x115	100x215	58





ÜRÜN ÖZELLİKLERİ/PRODUCT SPECIFICATIONS

Ürün Tanımı	Sıva Altı Spot	Product Description	Recessed Downlight
Gövde	Alüminyum Enjeksiyon	Body	Die-Cast Aluminum
Boya	Elektrostatik Toz Boya	Paint	Electrostatic Powder Coated
PCB		PCB	
Lens		Lens	
Reflektör	Yüksek Safılıkta Alüminyum	Reflector	High Purity Aluminum
Difüzör	Temperli Cam	Diffuser	Tempered Glass
SDCM (MacAdam)	3	SDCM (MacAdam)	3
Renk Sıcaklığı	2700K/3000K/4000K	Colour Temperature	2700K/3000K/4000K
Ömür	50000h	Life Time	50000h
Çalışma Sıcaklığı	25°C	Operating Temperature	25°C
LED	Osram/Samsung	LED	Osram/Samsung
Sürücü		Driver	
Uygunluk	EN 60598-1 EN 60598-2-2	Conformity	EN 60598-1 EN 60598-2-2

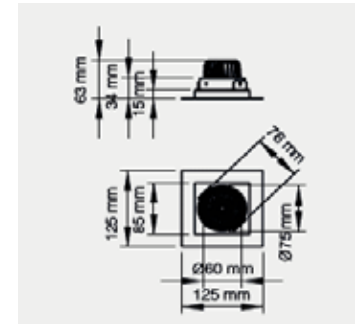

Ürün Kodu Product Code	Güç Power	Çıkış Işık Akısı Lumen Output	Verimlilik Efficiency	Işık Açısı Beam Angle	Işık Kaynağı Light Source	CRI	LxW (mm)	CUT (mm)	H (mm)
21001	5W	350Lm	70Lm/W	35°	GU10	80	125x125	100x100	63
21089	8W	654Lm	81Lm/W	15°/30°/45°/60°	LED	80	125x125	100x100	63





ÜRÜN ÖZELLİKLERİ/PRODUCT SPECIFICATIONS

Ürün Tanımı	Sıva Altı Spot	Product Description	Recessed Downlight
Gövde	Alüminyum Enjeksiyon	Body	Die-Cast Aluminum
Boya	Elektrostatik Toz Boya	Paint	Elektrostatic Powder Coated
PCB		PCB	
Lens		Lens	
Reflektör	Yüksek Safılıkta Alüminyum	Reflector	High Purity Aluminum
Difüzör	Temperli Cam	Diffuser	Tempered Glass
SDCM (MacAdam)	3	SDCM (MacAdam)	3
Renk Sıcaklığı	2700K/3000K/4000K	Colour Temperature	2700K/3000K/4000K
Ömür	50000h	Life Time	50000h
Çalışma Sıcaklığı	25°C	Operating Temperature	25°C
LED	Osram/Samsung	LED	Osram/Samsung
Sürücü		Driver	
Uygunluk	EN 60598-1 EN 60598-2-2	Conformity	EN 60598-1 EN 60598-2-2

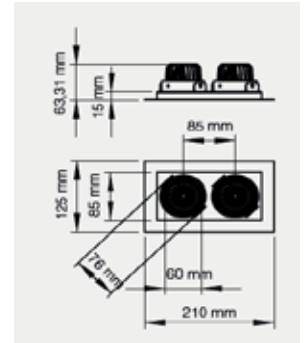

Ürün Kodu Product Code	Güç Power	Çıkış Işık Akısı Lumen Output	Verimlilik Efficiency	Işık Açısı Beam Angle	Işık Kaynağı Light Source	CRI	LxW (mm)	CUT (mm)	H (mm)
23004	2x5W	2x350Lm	70Lm/W	35°	GU10	80	210x125	100x190	63
23033	2x8W	2x654Lm	81Lm/W	15°/30°/45°/60°	LED	80	210x125	100x190	63



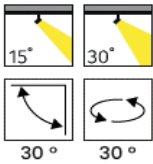

ÜRÜN ÖZELLİKLERİ/PRODUCT SPECIFICATIONS

Ürün Tanımı	Sıva Altı Spot	Product Description	Recessed Downlight
Gövde	Alüminyum Enjeksiyon	Body	Die-Cast Aluminum
Boya	Elektrostatik Toz Boya	Paint	Electrostatic Powder Coated
PCB		PCB	
Lens		Lens	
Reflektör	Yüksek Safılıkta Alüminyum	Reflector	High Purity Aluminum
Difüzör	Temperli Cam	Diffuser	Tempered Glass
SDCM (MacAdam)	3	SDCM (MacAdam)	3
Renk Sıcaklığı	2700K/3000K/4000K	Colour Temperature	2700K/3000K/4000K
Ömür	50000h	Life Time	50000h
Çalışma Sıcaklığı	25°C	Operating Temperature	25°C
LED	Osram/Samsung	LED	Osram/Samsung
Sürücü		Driver	
Uygunluk	EN 60598-1 EN 60598-2-2	Conformity	EN 60598-1 EN 60598-2-2

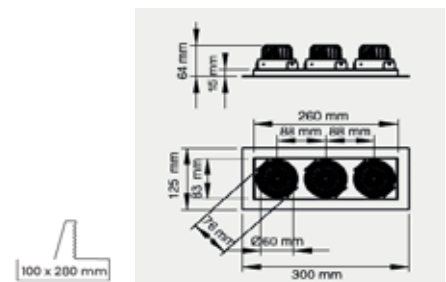

Ürün Kodu Product Code	Güç Power	Çıkış Işık Akısı Lumen Output	Verimlilik Efficiency	Işık Açısı Beam Angle	Işık Kaynağı Light Source	CRI	LxW (mm)	CUT (mm)	H (mm)
21389	24W	2125Lm	88Lm/W	15°/30°	LED	80	300x125	280x100	64
21390	3x5W	1380Lm	88Lm/W	35°	GU10	80	300x125	280x100	64



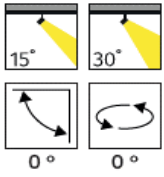
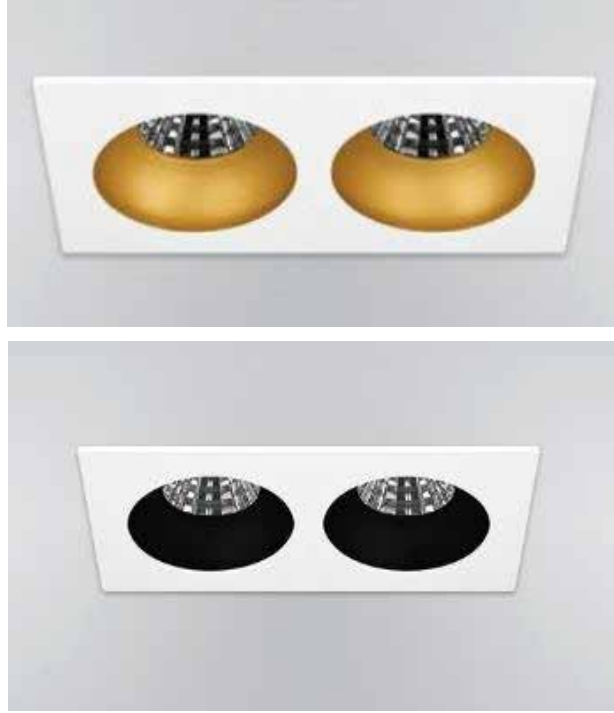

ÜRÜN ÖZELLİKLERİ/PRODUCT SPECIFICATIONS

Ürün Tanımı	Siva Altı Spot	Product Description	Recessed Downlight
Gövde	Alüminyum Enjeksiyon	Body	Die-Cast Aluminum
Boya	Elektrostatik Toz Boya	Paint	Electrostatic Powder Coated
PCB		PCB	
Lens		Lens	
Reflektör	Yüksek Safılıkta Alüminyum	Reflector	High Purity Aluminum
Difüzör		Diffuser	
SDCM (MacAdam)	3	SDCM (MacAdam)	3
Renk Sıcaklığı	2700K/3000K/4000K	Colour Temperature	2700K/3000K/4000K
Ömür	50000h	Life Time	50000h
Çalışma Sıcaklığı	25°C	Operating Temperature	25°C
LED	Osram/Samsung	LED	Osram/Samsung
Sürücü		Driver	
Uygunluk	EN 60598-1 EN 60598-2-2	Conformity	EN 60598-1 EN 60598-2-2

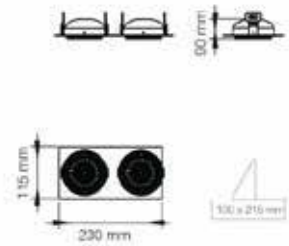

Ürün Kodu Product Code	Güç Power	Çıkış Işık Akısı Lumen Output	Verimlilik Efficiency	Işık Açısı Beam Angle	Işık Kaynağı Light Source	CRI	LxW (mm)	CUT (mm)	H (mm)
23044	2x5W	920Lm	92Lm/W	35°	GU10	80	230x115	100x215	90
23045	2x15W	1242Lm	82Lm/W	15°/30°	LED	80	230x115	100x215	90
23046	2x20W	1774Lm	88Lm/W	15°/30°	LED	80	230x115	100x215	90



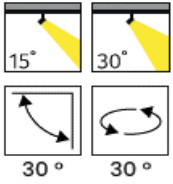

ÜRÜN ÖZELLİKLERİ/PRODUCT SPECIFICATIONS

Ürün Tanımı	Sıva Altı Spot	Product Description	Recessed Downlight
Gövde	Alüminyum Enjeksiyon	Body	Die-Cast Aluminum
Boya	Elektrostatik Toz Boya	Paint	Elektrostatic Powder Coated
PCB		PCB	
Lens		Lens	
Reflektör	Yüksek Safılıkta Alüminyum	Reflector	High Purity Aluminum
Difüzör	Temperli Cam	Diffuser	Tempered Glass
SDCM (MacAdam)	3	SDCM (MacAdam)	3
Renk Sıcaklığı	2700K/3000K/4000K	Colour Temperature	2700K/3000K/4000K
Ömür	50000h	Life Time	50000h
Çalışma Sıcaklığı	25°C	Operating Temperature	25°C
LED	Osram/Samsung	LED	Osram/Samsung
Sürücü		Driver	
Uygunluk	EN 60598-1 EN 60598-2-2	Conformity	EN 60598-1 EN 60598-2-2

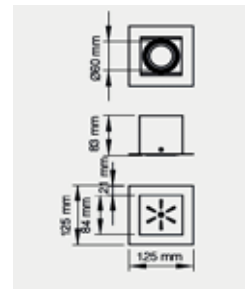

Ürün Kodu Product Code	Güç Power	Çıkış Işık Akısı Lumen Output	Verimlilik Efficiency	Işık Açısı Beam Angle	Işık Kaynağı Light Source	CRI	LxW (mm)	CUT (mm)	H (mm)
21099	10W	1000lm	100lm/W	15°/30°	LED	80	125x125	100x100	83
21056	5W	350lm	70lm/W	35°	GU10	80	125x125	100x100	83



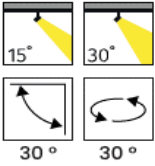

ÜRÜN ÖZELLİKLERİ/PRODUCT SPECIFICATIONS

Ürün Tanımı	Sıva Altı Spot	Product Description	Recessed Downlight
Gövde	Alüminyum Enjeksiyon	Body	Die-Cast Aluminum
Boya	Elektrostatik Toz Boya	Paint	Elektrostatic Powder Coated
PCB		PCB	
Lens		Lens	
Reflektör	Yüksek Safılıkta Alüminyum	Reflector	High Purity Aluminum
Difüzör	Temperli Cam	Diffuser	Tempered Glass
SDCM (MacAdam)	3	SDCM (MacAdam)	3
Renk Sıcaklığı	2700K/3000K/4000K	Colour Temperature	2700K/3000K/4000K
Ömür	50000h	Life Time	50000h
Çalışma Sıcaklığı	25°C	Operating Temperature	25°C
LED	Osram/Samsung	LED	Osram/Samsung
Sürücü		Driver	
Uygunluk	EN 60598-1 EN 60598-2-2	Conformity	EN 60598-1 EN 60598-2-2

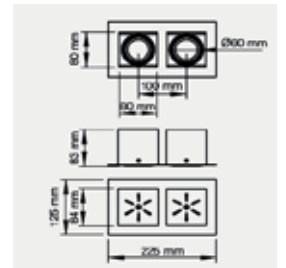

Ürün Kodu Product Code	Güç Power	Çıkış Işık Akısı Lumen Output	Verimlilik Efficiency	Işık Açısı Beam Angle	Işık Kaynağı Light Source	CRI	LxW (mm)	CUT (mm)	H (mm)
23034	2x8W	2x654Lm	81Lm/W	15°/30°	LED	80	225x125	100x200	83
23001	2x5W	2x350Lm	70Lm/W	35°	GU10	80	225x125	100x200	83



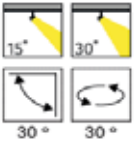

ÜRÜN ÖZELLİKLERİ/PRODUCT SPECIFICATIONS

Ürün Tanımı	Sıva Altı Spot	Product Description	Recessed Downlight
Gövde	Alüminyum Enjeksiyon	Body	Die-Cast Aluminum
Boya	Elektrostatik Toz Boya	Paint	Elektrostatic Powder Coated
PCB		PCB	
Lens		Lens	
Reflektör	Yüksek Safılıkta Alüminyum	Reflector	High Purity Aluminum
Difüzör	Temperli Cam	Diffuser	Tempered Glass
SDCM (MacAdam)	3	SDCM (MacAdam)	3
Renk Sıcaklığı	2700K/3000K/4000K	Colour Temperature	2700K/3000K/4000K
Ömür	50000h	Life Time	50000h
Çalışma Sıcaklığı	25°C	Operating Temperature	25°C
LED	Osram/Samsung	LED	Osram/Samsung
Sürücü		Driver	
Uygunluk	EN 60598-1 EN 60598-2-2	Conformity	EN 60598-1 EN 60598-2-2

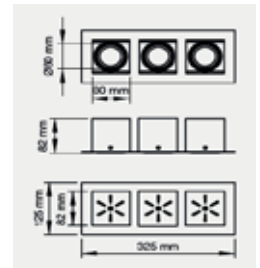

Ürün Kodu Product Code	Güç Power	Çıkış Işık Akısı Lumen Output	Verimlilik Efficiency	Işık Açısı Beam Angle	Işık Kaynağı Light Source	CRI	LxW (mm)	CUT (mm)	H (mm)
24030	3x8W	3x654Lm	81Lm/W	15°/30°	LED	80	325x125	100x300	82
24031	3x5W	3x350Lm	70Lm/W	35°	GU10	80	325x125	100x300	82



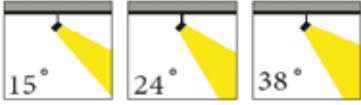

ÜRÜN ÖZELLİKLERİ/PRODUCT SPECIFICATIONS

Ürün Tanımı	Sıva Altı Spot	Product Description	Recessed Downlight
Gövde	Alüminyum Gövde	Body	Aluminum Housing
Boya	Elektrostatik Toz Boya	Paint	Elektrostatic Powder Coated
PCB		PCB	
Lens		Lens	
Reflektör		Reflector	
Difüzör		Diffuser	
SDCM (MacAdam)	3	SDCM (MacAdam)	3
Renk Sıcaklığı	2700K/3000K/4000K	Colour Temperature	2700K/3000K/4000K
Ömür	50000h	Life Time	50000h
Çalışma Sıcaklığı	25°C	Operating Temperature	25°C
LED		LED	
Sürücü		Driver	
Uygunluk	EN 60598-1 EN 60598-2-2	Conformity	EN 60598-1 EN 60598-2-2



Ürün Kodu Product Code	Güç Power	Çıkış Işık Akısı Lumen Output	Verimlilik Efficiency	Işık Açısı Beam Angle	Işık Kaynağı Light Source	CRI	LxW (mm)	CUT (mm)	H (mm)
21304	5W	350Lm	70Lm/W	35°	GU10	80	85x85	70x70	100
21305	8W	800Lm	100Lm/W	15°/24°/38°	LED	80	85x85	70x70	100
21306	10W	1000Lm	100Lm/W	15°/24°/38°	LED	80	85x85	70x70	100
21307	12W	1200Lm	100Lm/W	15°/24°/38°	LED	80	85x85	70x70	100





ÜRÜN ÖZELLİKLERİ/PRODUCT SPECIFICATIONS

Ürün Tanımı	Sıva Altı Hareketli Spot	Product Description	Recessed Adjustable Downlight
Gövde	Alüminyum Enjeksiyon	Body	Die-Cast Aluminum
Boya	Elektrostatik Toz Boya	Paint	Electrostatic Powder Coated
PCB		PCB	
Lens		Lens	
Reflektör	Yüksek Safılıkta Alüminyum	Reflector	High Purity Aluminum
Difüzör		Diffuser	
SDCM (MacAdam)	3	SDCM (MacAdam)	3
Renk Sıcaklığı	2700K/3000K/4000K	Colour Temperature	2700K/3000K/4000K
Ömür	50000h	Life Time	50000h
Çalışma Sıcaklığı	25°C	Operating Temperature	25°C
LED	Osram/Tridonic/Nichia/Samsung/Cree	LED	Osram/Tridonic/Nichia/Samsung/Cree
Sürücü		Driver	
Uygunluk	EN 60598-1 EN 60598-2-2	Conformity	EN 60598-1 EN 60598-2-2

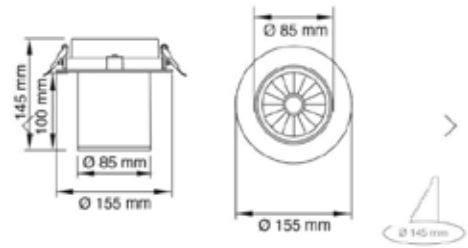

Ürün Kodu Product Code	Güç Power	Çıkış Işık Akısı Lumen Output	Verimlilik Efficiency	Işık Açısı Beam Angle	Işık Kaynağı Light Source	CRI	Ø (mm)	CUT (mm)	H (mm)
21300	30W	2938Lm	97Lm/W	15°/30°/45°/60°	LED	80	155	145	145
21301	35W	3256Lm	95Lm/W	15°/30°/45°/60°	LED	80	155	145	145





ÜRÜN ÖZELLİKLERİ/PRODUCT SPECIFICATIONS

Ürün Tanımı	Sıva Altı Hareketli Spot	Product Description	Recessed Adjustable Downlight
Gövde	Alüminyum Enjeksiyon	Body	Die-Cast Aluminum
Boya	Elektrostatik Toz Boya	Paint	Electrostatic Powder Coated
PCB		PCB	
Lens		Lens	
Reflektör	Yüksek Safılıkta Alüminyum	Reflector	High Purity Aluminum
Difüzör		Diffuser	
SDCM (MacAdam)	3	SDCM (MacAdam)	3
Renk Sıcaklığı	2700K/3000K/4000K	Colour Temperature	2700K/3000K/4000K
Ömür	50000h	Life Time	50000h
Çalışma Sıcaklığı	25°C	Operating Temperature	25°C
LED	Osram/Samsung	LED	Osram/Samsung
Sürücü		Driver	
Uygunluk	EN 60598-1 EN 60598-2-2	Conformity	EN 60598-1 EN 60598-2-2

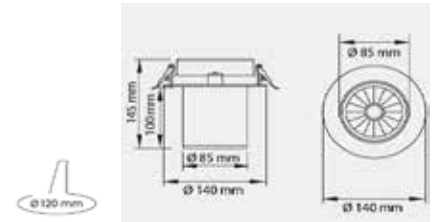

Ürün Kodu Product Code	Güç Power	Çıkış Işık Akısı Lumen Output	Verimlilik Efficiency	Işık Açısı Beam Angle	Işık Kaynağı Light Source	CRI	Ø (mm)	CUT (mm)	H (mm)
21391	15W	1242lm	83lm/W	15°/30°/45°	LED	80	140	120	145
21392	20W	1774lm	88lm/W	15°/30°/45°	LED	80	140	120	145



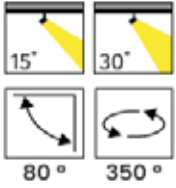

ÜRÜN ÖZELLİKLERİ/PRODUCT SPECIFICATIONS

Ürün Tanımı	Sıva Altı Hareketli Spot	Product Description	Recessed Adjustable Downlight
Gövde	Alüminyum Enjeksiyon	Body	Die-Cast Aluminum
Boya	Elektrostatik Toz Boya	Paint	Electrostatic Powder Coated
PCB		PCB	
Lens		Lens	
Reflektör	Yüksek Safılıkta Alüminyum	Reflector	High Purity Aluminum
Difüzör		Diffuser	
SDCM (MacAdam)	3	SDCM (MacAdam)	3
Renk Sıcaklığı	2700K/3000K/4000K	Colour Temperature	2700K/3000K/4000K
Ömür	50000h	Life Time	50000h
Çalışma Sıcaklığı	25°C	Operating Temperature	25°C
LED	Osram/Samsung	LED	Osram/Samsung
Sürücü		Driver	
Uygunluk	EN 60598-1 EN 60598-2-2	Conformity	EN 60598-1 EN 60598-2-2

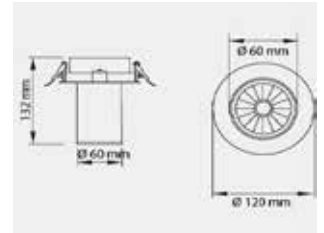

Ürün Kodu Product Code	Güç Power	Çıkış Işık Akısı Lumen Output	Verimlilik Efficiency	Işık Açısı Beam Angle	Işık Kaynağı Light Source	CRI	Ø (mm)	CUT (mm)	H (mm)
21393	8W	587Lm	73Lm/W	15°/30°	LED	80	120	105	132
21394	10W	654Lm	65Lm/W	15°/30°	LED	80	120	105	132
70020	5W	350Lm	70Lm/W	15°/30°	GU10	80	120	105	132
70021	8W	654Lm	80Lm/W	15°/30°	GU10	80	120	105	132





ÜRÜN ÖZELLİKLERİ/PRODUCT SPECIFICATIONS

Ürün Tanımı	Sıva Altı Hareketli Spot	Product Description	Recessed Adjustable Downlight
Gövde	Alüminyum Enjeksiyon	Body	Die-Cast Aluminum
Boya	Elektrostatik Toz Boya	Paint	Electrostatic Powder Coated
PCB		PCB	
Lens		Lens	
Reflektör	Yüksek Safılıkta Alüminyum	Reflector	High Purity Aluminum
Difüzör		Diffuser	
SDCM (MacAdam)	3	SDCM (MacAdam)	3
Renk Sıcaklığı	2700K/3000K/4000K	Colour Temperature	2700K/3000K/4000K
Ömür	50000h	Life Time	50000h
Çalışma Sıcaklığı	25°C	Operating Temperature	25°C
LED	Osram/Samsung	LED	Osram/Samsung
Sürücü		Driver	
Uygunluk	EN 60598-1 EN 60598-2-2	Conformity	EN 60598-1 EN 60598-2-2

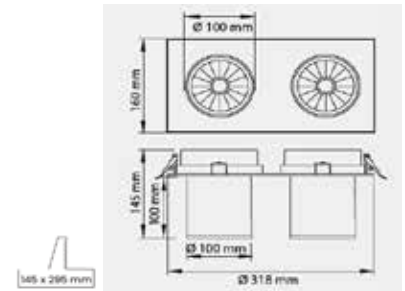

Ürün Kodu Product Code	Güç Power	Çıkış Işık Akısı Lumen Output	Verimlilik Efficiency	Işık Açısı Beam Angle	Işık Kaynağı Light Source	CRI	Ø (mm)	CUT (mm)	H (mm)
23063	2X30W	2938Lm	93Lm/W	15°/30°/45°/60°	LED	80	318	145X295	145
23064	2X35W	3256Lm	89Lm/W	15°/30°/45°/60°	LED	80	318	145X295	145





ÜRÜN ÖZELLİKLERİ/PRODUCT SPECIFICATIONS

Ürün Tanımı	Sıva Altı Hareketli Spot	Product Description	Recessed Adjustable Downlight
Gövde	Alüminyum Enjeksiyon	Body	Die-Cast Aluminum
Boya	Elektrostatik Toz Boya	Paint	Electrostatic Powder Coated
PCB		PCB	
Lens		Lens	
Reflektör	Yüksek Safılıkta Alüminyum	Reflector	High Purity Aluminum
Difüzör		Diffuser	
SDCM (MacAdam)	3	SDCM (MacAdam)	3
Renk Sıcaklığı	2700K/3000K/4000K	Colour Temperature	2700K/3000K/4000K
Ömür	50000h	Life Time	50000h
Çalışma Sıcaklığı	25°C	Operating Temperature	25°C
LED	Osram/Samsung	LED	Osram/Samsung
Sürücü		Driver	
Uygunluk	EN 60598-1 EN 60598-2-2	Conformity	EN 60598-1 EN 60598-2-2

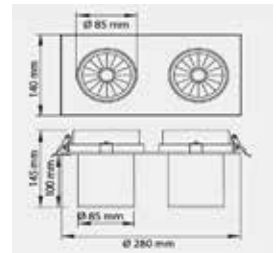

Ürün Kodu Product Code	Güç Power	Çıkış Işık Akısı Lumen Output	Verimlilik Efficiency	Işık Açısı Beam Angle	Işık Kaynağı Light Source	CRI	Ø (mm)	CUT (mm)	H (mm)
23065	30W	2530Lm	93Lm/W	15°/30°/45°	LED	80	280	120X265	145
23066	40W	3537Lm	85Lm/W	15°/30°/45°	LED	80	280	120X265	145



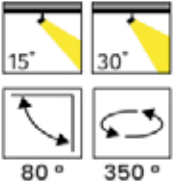

ÜRÜN ÖZELLİKLERİ/PRODUCT SPECIFICATIONS

Ürün Tanımı	Sıva Altı Hareketli Spot	Product Description	Recessed Adjustable Downlight
Gövde	Alüminyum Enjeksiyon	Body	Die-Cast Aluminum
Boya	Elektrostatik Toz Boya	Paint	Electrostatic Powder Coated
PCB		PCB	
Lens		Lens	
Reflektör	Yüksek Safılıkta Alüminyum	Reflector	High Purity Aluminum
Difüzör		Diffuser	
SDCM (MacAdam)	3	SDCM (MacAdam)	3
Renk Sıcaklığı	2700K/3000K/4000K	Colour Temperature	2700K/3000K/4000K
Ömür	50000h	Life Time	50000h
Çalışma Sıcaklığı	25°C	Operating Temperature	25°C
LED	Osram/Samsung	LED	Osram/Samsung
Sürücü		Driver	
Uygunluk	EN 60598-1 EN 60598-2-2	Conformity	EN 60598-1 EN 60598-2-2

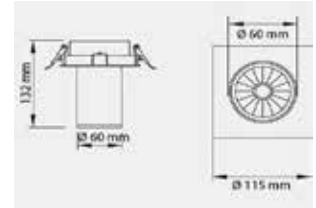

Ürün Kodu Product Code	Güç Power	Çıkış Işık Akısı Lumen Output	Verimlilik Efficiency	Işık Açısı Beam Angle	Işık Kaynağı Light Source	CRI	Ø (mm)	CUT (mm)	H (mm)
21395	8W	587Lm	73Lm/W	15°/30°	LED	80	115	100	132
21396	10W	654Lm	65Lm/W	15°/30°	LED	80	115	100	132
70022	5W	350Lm	70Lm/W	15°/30°	GU10	80	115	100	132
70023	8W	654Lm	80Lm/W	15°/30°	GU10	80	115	100	132



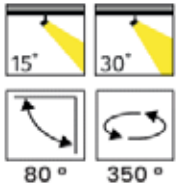

ÜRÜN ÖZELLİKLERİ/PRODUCT SPECIFICATIONS

Ürün Tanımı	Sıva Altı Hareketli Spot	Product Description	Recessed Adjustable Downlight
Gövde	Alüminyum Enjeksiyon	Body	Die-Cast Aluminum
Boya	Elektrostatik Toz Boya	Paint	Electrostatic Powder Coated
PCB		PCB	
Lens		Lens	
Reflektör	Yüksek Safılıkta Alüminyum	Reflector	High Purity Aluminum
Difüzör		Diffuser	
SDCM (MacAdam)	3	SDCM (MacAdam)	3
Renk Sıcaklığı	2700K/3000K/4000K	Colour Temperature	2700K/3000K/4000K
Ömür	50000h	Life Time	50000h
Çalışma Sıcaklığı	25°C	Operating Temperature	25°C
LED	Osram/Samsung	LED	Osram/Samsung
Sürücü		Driver	
Uygunluk	EN 60598-1 EN 60598-2-2	Conformity	EN 60598-1 EN 60598-2-2

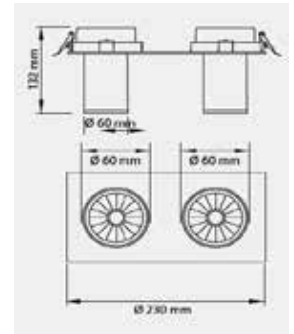

Ürün Kodu Product Code	Güç Power	Çıkış Işık Akısı Lumen Output	Verimlilik Efficiency	Işık Açısı Beam Angle	Işık Kaynağı Light Source	CRI	Ø (mm)	CUT (mm)	H (mm)
21397	15W	1242Lm	89Lm/W	15°/30°	LED	80	230	100X215	132
21398	20W	654Lm	89Lm/W	15°/30°	LED	80	230	100X215	132
70024	2X5W	700Lm	70Lm/W	15°/30°	GU10	80	230	100X215	132
70025	2X8W	1340Lm	80Lm/W	15°/30°	GU10	80	230	100X215	132





ÜRÜN ÖZELLİKLERİ/PRODUCT SPECIFICATIONS

Ürün Tanımı	Siva Altı Hareketli Spot	Product Descripton	Recessed Adjustable Downlight
Gövde	Alüminyum Enjeksiyon	Body	Die-Cast Aluminum
Boya	Elektrostatik Toz Boya	Paint	Electrostatic Powder Coated
PCB		PCB	
Lens		Lens	
Reflektör	Yüksek Safılıkta Alüminyum	Reflector	High Purity Aluminum
Difüzör		Diffuser	
SDCM (MacAdam)	3	SDCM (MacAdam)	3
Renk Sıcaklığı	2700K/3000K/4000K	Colour Temperature	2700K/3000K/4000K
Ömür	50000h	Life Time	50000h
Çalışma Sıcaklığı	25°C	Operating Temperature	25°C
LED	Osram/Samsung	LED	Osram/Samsung
Sürücü		Driver	
Uygunluk	EN 60598-1 EN 60598-2-2	Conformity	EN 60598-1 EN 60598-2-2

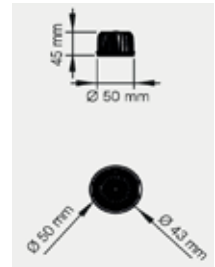

Ürün Kodu Product Code	Güç Power	Çıkış Işık Akısı Lumen Output	Verimlilik Efficiency	Işık Açısı Beam Angle	Işık Kaynağı Light Source	CRI	Ø (mm)	H (mm)
21399	8W	587Lm	73Lm/W	15°/30°	LED	80	50	45
21400	10W	654Lm	65Lm/W	15°/30°	LED	80	230	132





ÜRÜN ÖZELLİKLERİ/PRODUCT SPECIFICATIONS

Ürün Tanımı	Sıva Altı Hareketli Spot	Product Description	Recessed Adjustable Downlight
Gövde	Alüminyum Enjeksiyon	Body	Die-Cast Aluminum
Boya	Elektrostatik Toz Boya	Paint	Electrostatic Powder Coated
PCB		PCB	
Lens		Lens	
Reflektör	Yüksek Safılıkta Alüminyum	Reflector	High Purity Aluminum
Difüzör	Temperli Cam	Diffuser	Tempered Glass
SDCM (MacAdam)	3	SDCM (MacAdam)	3
Renk Sıcaklığı	3000K	Colour Temperature	3000K
Ömür	50000h	Life Time	50000h
Çalışma Sıcaklığı	25°C	Operating Temperature	25°C
LED	Osram/Tridonic/Nichia/Samsung/Cree	LED	Osram/Tridonic/Nichia/Samsung/Cree
Sürücü		Driver	
Uygunluk	EN 60598-1 EN 60598-2-2	Conformity	EN 60598-1 EN 60598-2-2

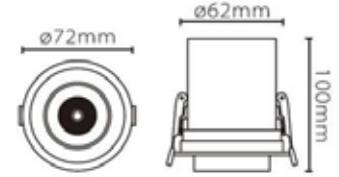

Ürün Kodu Product Code	Güç Power	Çıkış Işık Akısı Lumen Output	Verimlilik Efficiency	Işık Açısı Beam Angle	Işık Kaynağı Light Source	CRI	Ø (mm)	CUT (mm)	H (mm)
21302	7W	630Lm	90Lm/W	36°	LED	80	72	62	100
21303	12W	1080Lm	90Lm/W	36°	LED	80	100	90	110



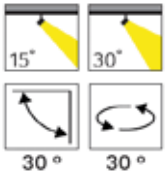

ÜRÜN ÖZELLİKLERİ/PRODUCT SPECIFICATIONS

Ürün Tanımı	Sıva Altı Spot	Product Description	Recessed Downlight
Gövde	Alüminyum Enjeksiyon	Body	Die-Cast Aluminum
Boya	Elektrostatik Toz Boya	Paint	Electrostatic Powder Coated
PCB		PCB	
Lens		Lens	
Reflektör	Yüksek Safılıkta Alüminyum	Reflector	High Purity Aluminum
Difüzör	Temperli Cam	Diffuser	Tempered Glass
SDCM (MacAdam)	3	SDCM (MacAdam)	3
Renk Sıcaklığı	2700K/3000K/4000K	Colour Temperature	2700K/3000K/4000K
Ömür	50000h	Life Time	50000h
Çalışma Sıcaklığı	25°C	Operating Temperature	25°C
LED	Osram/Samsung	LED	Osram/Samsung
Sürücü		Driver	
Uygunluk	EN 60598-1 EN 60598-2-2	Conformity	EN 60598-1 EN 60598-2-2

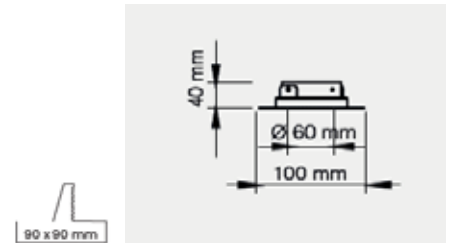

Ürün Kodu Product Code	Güç Power	Çıkış Işık Akısı Lumen Output	Verimlilik Efficiency	Işık Açısı Beam Angle	Işık Kaynağı Light Source	CRI	LxW (mm)	CUT (mm)	H (mm)
21401	5W	350Lm	92Lm/W	35°	GU 10	80	100x100	90x90	40
21402	8W	670Lm	83Lm/W	35°	GU 10	80	100x100	90x90	40
70026	8W	587Lm	83Lm/W	15°/30°	LED	80	100x100	90x90	40
70027	10W	654Lm	65Lm/W	15°/30°	LED	80	100x100	90x90	40



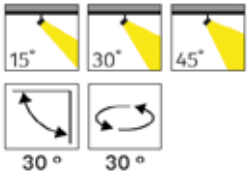

ÜRÜN ÖZELLİKLERİ/PRODUCT SPECIFICATIONS

Ürün Tanımı	Sıva Altı Spot	Product Description	Recessed Downlight
Gövde	Alüminyum Enjeksiyon	Body	Die-Cast Aluminum
Boya	Elektrostatik Toz Boya	Paint	Electrostatic Powder Coated
PCB		PCB	
Lens		Lens	
Reflektör	Yüksek Safılıkta Alüminyum	Reflector	High Purity Aluminum
Difüzör	Temperli Cam	Diffuser	Tempered Glass
SDCM (MacAdam)	3	SDCM (MacAdam)	3
Renk Sıcaklığı	2700K/3000K/4000K/6500K	Colour Temperature	2700K/3000K/4000K/6500K
Ömür	50000h	Life Time	50000h
Çalışma Sıcaklığı	25°C	Operating Temperature	25°C
LED	Osram/Samsung	LED	Osram/Samsung
Sürücü		Driver	
Uygunluk	EN 60598-1 EN 60598-2-2	Conformity	EN 60598-1 EN 60598-2-2

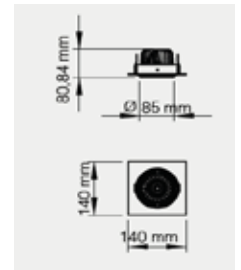

Ürün Kodu Product Code	Güç Power	Çıkış Işık Akısı Lumen Output	Verimlilik Efficiency	Işık Açısı Beam Angle	Işık Kaynağı Light Source	CRI	LxW (mm)	CUT (mm)	H (mm)
21018	15W	1442Lm	89,2Lm/W	15°/30°/45°	LED	80	140x140	120x120	80,84
21019	20W	1774Lm	89,2Lm/W	15°/30°/45°	LED	80	140x140	120x120	80,84



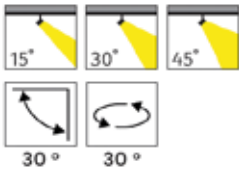

ÜRÜN ÖZELLİKLERİ/PRODUCT SPECIFICATIONS

Ürün Tanımı	Sıva Altı Spot	Product Descripton	Recessed Downlight
Gövde	Alüminyum Enjeksiyon	Body	Die-Cast Aluminum
Boya	Elektrostatik Toz Boya	Paint	Electrostatic Powder Coated
PCB		PCB	
Lens		Lens	
Reflektör	Yüksek Saflıkta Alüminyum	Reflector	High Purity Aluminum
Difüzör	Temperli Cam	Diffuser	Tempered Glass
SDCM (MacAdam)	3	SDCM (MacAdam)	3
Renk Sıcaklığı	2700K/3000K/4000K/6500K	Colour Temperature	2700K/3000K/4000K/6500K
Ömür	50000h	Life Time	50000h
Çalışma Sıcaklığı	25°C	Operating Temperature	25°C
LED	Osram/Samsung	LED	Osram/Samsung
Sürücü		Driver	
Uygunluk	EN 60598-1 EN 60598-2-2	Conformity	EN 60598-1 EN 60598-2-2

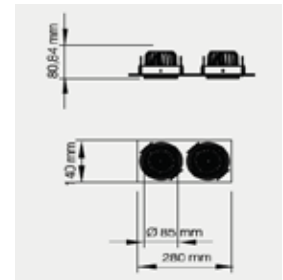

Ürün Kodu Product Code	Güç Power	Çıkış Işık Akısı Lumen Output	Verimlilik Efficiency	Işık Açısı Beam Angle	Işık Kaynağı Light Source	CRI	LxW (mm)	CUT (mm)	H (mm)
23069	30W	2530Lm	93Lm/W	15°/30°/45°	LED	80	280x140	120x265	80,84
23070	40W	3537Lm	85,3Lm/W	15°/30°/45°	LED	80	280x140	120x265	80,84



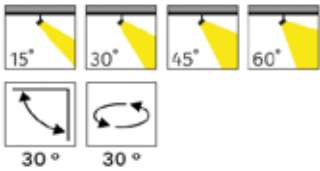

ÜRÜN ÖZELLİKLERİ/PRODUCT SPECIFICATIONS

Ürün Tanımı	Sıva Altı Spot	Product Description	Recessed Downlight
Gövde	Alüminyum Enjeksiyon	Body	Die-Cast Aluminum
Boya	Elektrostatik Toz Boya	Paint	Electrostatic Powder Coated
PCB		PCB	
Lens		Lens	
Reflektör	Yüksek Safılıkta Alüminyum	Reflector	High Purity Aluminum
Difüzör	Temperli Cam	Diffuser	Tempered Glass
SDCM (MacAdam)	3	SDCM (MacAdam)	3
Renk Sıcaklığı	2700K/3000K/4000K/6500K	Colour Temperature	2700K/3000K/4000K/6500K
Ömür	50000h	Life Time	50000h
Çalışma Sıcaklığı	25°C	Operating Temperature	25°C
LED	Osram/Samsung	LED	Osram/Samsung
Sürücü		Driver	
Uygunluk	EN 60598-1 EN 60598-2-2	Conformity	EN 60598-1 EN 60598-2-2

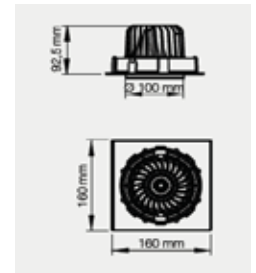

Ürün Kodu Product Code	Güç Power	Çıkış Işık Akısı Lumen Output	Verimlilik Efficiency	Işık Açısı Beam Angle	Işık Kaynağı Light Source	CRI	LxW (mm)	CUT (mm)	H (mm)
21406	20W	1774Lm	89,2Lm/W	15°/30°/45°/60°	LED	80	160x160	145x145	92,5
21407	30W	2938Lm	93Lm/W	15°/30°/45°/60°	LED	80	160x160	145x145	92,5



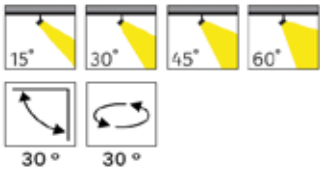

ÜRÜN ÖZELLİKLERİ/PRODUCT SPECIFICATIONS

Ürün Tanımı	Sıva Altı Spot	Product Descripton	Recessed Downlight
Gövde	Alüminyum Enjeksiyon	Body	Die-Cast Aluminum
Boya	Elektrostatik Toz Boya	Paint	Electrostatic Powder Coated
PCB		PCB	
Lens		Lens	
Reflektör	Yüksek Saflıkta Alüminyum	Reflector	High Purity Aluminum
Difüzör	Temperli Cam	Diffuser	Tempered Glass
SDCM (MacAdam)	3	SDCM (MacAdam)	3
Renk Sıcaklığı	2700K/3000K/4000K/6500K	Colour Temperature	2700K/3000K/4000K/6500K
Ömür	50000h	Life Time	50000h
Çalışma Sıcaklığı	25°C	Operating Temperature	25°C
LED	Osram/Samsung	LED	Osram/Samsung
Sürücü		Driver	
Uygunluk	EN 60598-1 EN 60598-2-2	Conformity	EN 60598-1 EN 60598-2-2

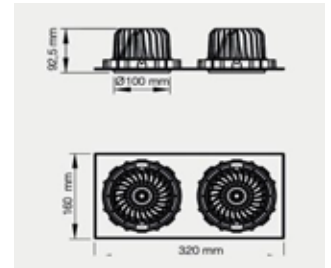

Ürün Kodu Product Code	Güç Power	Çıkış Işık Akısı Lumen Output	Verimlilik Efficiency	Işık Açısı Beam Angle	Işık Kaynağı Light Source	CRI	LxW (mm)	CUT (mm)	H (mm)
23067	40W	3548Lm	89,2Lm/W	15°/30°/45°/60°	LED	80	320x160	145x300	92,5
23068	60W	5876Lm	93Lm/W	15°/30°/45°/60°	LED	80	320x160	145x300	92,5



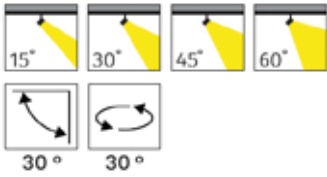

ÜRÜN ÖZELLİKLERİ/PRODUCT SPECIFICATIONS

Ürün Tanımı	Sıva Altı Spot	Product Description	Recessed Downlight
Gövde	Alüminyum Enjeksiyon	Body	Die-Cast Aluminum
Boya	Elektrostatik Toz Boya	Paint	Electrostatic Powder Coated
PCB		PCB	
Lens		Lens	
Reflektör	Yüksek Safılıkta Alüminyum	Reflector	High Purity Aluminum
Difüzör	Temperli Cam	Diffuser	Tempered Glass
SDCM (MacAdam)	3	SDCM (MacAdam)	3
Renk Sıcaklığı	2700K/3000K/4000K	Colour Temperature	2700K/3000K/4000K
Ömür	50000h	Life Time	50000h
Çalışma Sıcaklığı	25°C	Operating Temperature	25°C
LED	Osram/Samsung	LED	Osram/Samsung
Sürücü		Driver	
Uygunluk	EN 60598-1 EN 60598-2-2	Conformity	EN 60598-1 EN 60598-2-2

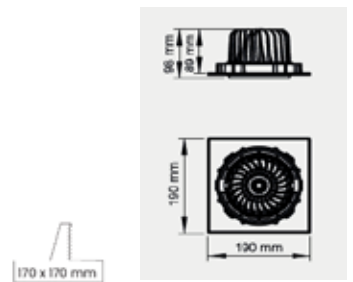

Ürün Kodu Product Code	Güç Power	Çıkış Işık Akısı Lumen Output	Verimlilik Efficiency	Işık Açısı Beam Angle	Işık Kaynağı Light Source	CRI	LxW (mm)	CUT (mm)	H (mm)
21051	15W	1455Lm	97Lm/W	15°/30°/45°/60°	LED	80	190x190	170x170	98
21052	20W	1940Lm	97Lm/W	15°/30°/45°/60°	LED	80	190x190	170x170	98
21053	30W	2938Lm	97Lm/W	15°/30°/45°/60°	LED	80	190x190	170x170	98
21054	35W	3256Lm	93Lm/W	15°/30°/45°/60°	LED	80	190x190	170x170	98



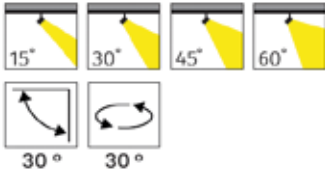

ÜRÜN ÖZELLİKLERİ/PRODUCT SPECIFICATIONS

Ürün Tanımı	Sıva Altı Spot	Product Description	Recessed Downlight
Gövde	Alüminyum Enjeksiyon	Body	Die-Cast Aluminum
Boya	Elektrostatik Toz Boya	Paint	Electrostatic Powder Coated
PCB		PCB	
Lens		Lens	
Reflektör	Yüksek Safılıkta Alüminyum	Reflector	High Purity Aluminum
Difüzör	Temperli Cam	Diffuser	Tempered Glass
SDCM (MacAdam)	3	SDCM (MacAdam)	3
Renk Sıcaklığı	2700K/3000K/4000K	Colour Temperature	2700K/3000K/4000K
Ömür	50000h	Life Time	50000h
Çalışma Sıcaklığı	25°C	Operating Temperature	25°C
LED	Osram/Samsung	LED	Osram/Samsung
Sürücü		Driver	
Uygunluk	EN 60598-1 EN 60598-2-2	Conformity	EN 60598-1 EN 60598-2-2

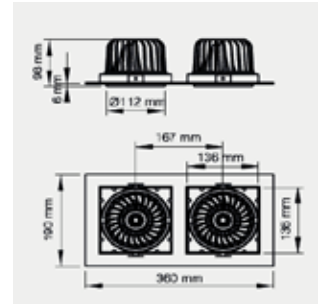

Ürün Kodu Product Code	Güç Power	Çıkış Işık Akısı Lumen Output	Verimlilik Efficiency	Işık Açısı Beam Angle	Işık Kaynağı Light Source	CRI	LxW (mm)	CUT (mm)	H (mm)
23024	2x15W	2x1455Lm	97Lm/W	15°/30°/45°/60°	LED	80	360x190	330x170	98
23025	2x20W	2x1940Lm	97Lm/W	15°/30°/45°/60°	LED	80	360x190	330x170	98
23026	2x25W	2x2425Lm	97Lm/W	15°/30°/45°/60°	LED	80	360x190	330x170	98
23027	2x30W	2x2938Lm	97Lm/W	15°/30°/45°/60°	LED	80	360x190	330x170	98
23028	2x35W	2x3256Lm	93Lm/W	15°/30°/45°/60°	LED	80	360x190	330x170	98



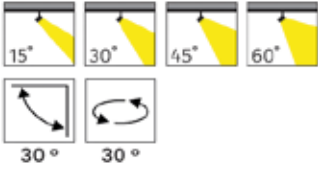

ÜRÜN ÖZELLİKLERİ/PRODUCT SPECIFICATIONS

Ürün Tanımı	Sıva Altı Spot	Product Descripton	Recessed Downlight
Gövde	Alüminyum Enjeksiyon	Body	Die-Cast Aluminum
Boya	Elektrostatik Toz Boya	Paint	Electrostatic Powder Coated
PCB		PCB	
Lens		Lens	
Reflektör	Yüksek Safılıkta Alüminyum	Reflector	High Purity Aluminum
Diffüzör	Temperli Cam	Diffuser	Tempered Glass
SDCM (MacAdam)	3	SDCM (MacAdam)	3
Renk Sıcaklığı	2700K/3000K/4000K	Colour Temperature	2700K/3000K/4000K
Ömür	50000h	Life Time	50000h
Çalışma Sıcaklığı	25°C	Operating Temperature	25°C
LED	Osram/Samsung	LED	Osram/Samsung
Sürücü		Driver	
Uygunluk	EN 60598-1 EN 60598-2-2	Conformity	EN 60598-1 EN 60598-2-2

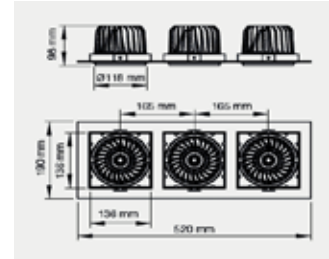

Ürün Kodu Product Code	Güç Power	Çıkış Işık Akısı Lumen Output	Verimlilik Efficiency	Işık Açısı Beam Angle	Işık Kaynağı Light Source	CRI	LxW (mm)	CUT (mm)	H (mm)
24019	3x15W	3x1455Lm	97Lm/W	15°/30°/45°/60°	LED	80	520x190	490x170	98
24020	3x20W	3x1940Lm	97Lm/W	15°/30°/45°/60°	LED	80	520x190	490x170	98
24021	3x25W	3x2425Lm	97Lm/W	15°/30°/45°/60°	LED	80	520x190	490x170	98
24022	3x30W	3x2938Lm	97Lm/W	15°/30°/45°/60°	LED	80	520x190	490x170	98
24023	3x35W	3x3256Lm	93Lm/W	15°/30°/45°/60°	LED	80	520x190	490x170	98



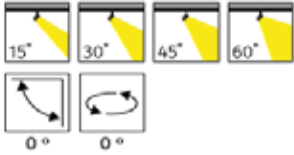

ÜRÜN ÖZELLİKLERİ/PRODUCT SPECIFICATIONS

Ürün Tanımı	Sıva Altı Spot	Product Description	Recessed Downlight
Gövde	Alüminyum Enjeksiyon	Body	Die-Cast Aluminum
Boya	Elektrostatik Toz Boya	Paint	Electrostatic Powder Coated
PCB		PCB	
Lens		Lens	
Reflektör	Yüksek Safılıkta Alüminyum	Reflector	High Purity Aluminum
Difüzör	Temperli Cam	Diffuser	Tempered Glass
SDCM (MacAdam)	3	SDCM (MacAdam)	3
Renk Sıcaklığı	2700K/3000K/4000K	Colour Temperature	2700K/3000K/4000K
Ömür	50000h	Life Time	50000h
Çalışma Sıcaklığı	25°C	Operating Temperature	25°C
LED	Osram/Samsung	LED	Osram/Samsung
Sürücü		Driver	
Uygunluk	EN 60598-1 EN 60598-2-2	Conformity	EN 60598-1 EN 60598-2-2

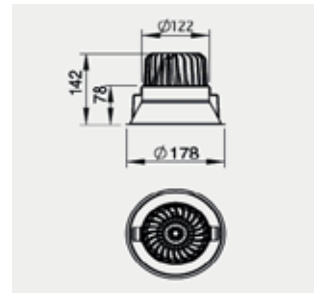

Ürün Kodu Product Code	Güç Power	Çıkış Işık Akısı Lumen Output	Verimlilik Efficiency	Işık Açısı Beam Angle	Işık Kaynağı Light Source	CRI	Ø (mm)	CUT (mm)	H (mm)
21044	15W	1455Lm	97Lm/W	15°/30°/45°/60°	LED	80	178	170	142
21045	20W	1940Lm	97Lm/W	15°/30°/45°/60°	LED	80	178	170	142
21156	25W	2425Lm	97Lm/W	15°/30°/45°/60°	LED	80	178	170	142
21046	30W	2938Lm	97Lm/W	15°/30°/45°/60°	LED	80	178	170	142



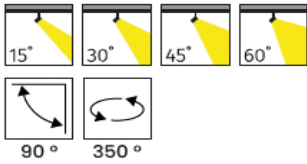

ÜRÜN ÖZELLİKLERİ/PRODUCT SPECIFICATIONS

Ürün Tanımı	Sıva Altı Spot	Product Description	Recessed Downlight
Gövde	Alüminyum Enjeksiyon	Body	Die-Cast Aluminum
Boya	Elektrostatik Toz Boya	Paint	Electrostatic Powder Coated
PCB		PCB	
Lens		Lens	
Reflektör	Yüksek Safılıkta Alüminyum	Reflector	High Purity Aluminum
Difüzör	Temperli Cam	Diffuser	Tempered Glass
SDCM (MacAdam)	3	SDCM (MacAdam)	3
Renk Sıcaklığı	2700K/3000K/4000K	Colour Temperature	2700K/3000K/4000K
Ömür	50000h	Life Time	50000h
Çalışma Sıcaklığı	25°C	Operating Temperature	25°C
LED	Osram/Samsung	LED	Osram/Samsung
Sürücü		Driver	
Uygunluk	EN 60598-1 EN 60598-2-2	Conformity	EN 60598-1 EN 60598-2-2

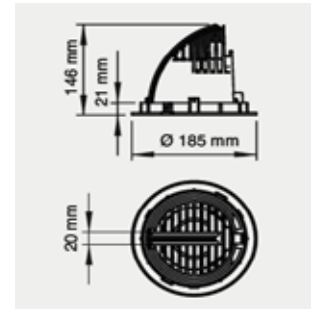

Ürün Kodu Product Code	Güç Power	Çıkış Işık Akısı Lumen Output	Verimlilik Efficiency	Işık Açısı Beam Angle	Işık Kaynağı Light Source	CRI	Ø (mm)	CUT (mm)	H (mm)
21040	15W	1455Lm	97Lm/W	15°/30°/45°/60°	LED	80	185	175	146
21041	20W	1940Lm	97Lm/W	15°/30°/45°/60°	LED	80	185	175	146
21042	30W	2938Lm	97Lm/W	15°/30°/45°/60°	LED	80	185	175	146
21043	35W	3256Lm	93Lm/W	15°/30°/45°/60°	LED	80	185	175	146





ÜRÜN ÖZELLİKLERİ/PRODUCT SPECIFICATIONS

Ürün Tanımı	Sıva Altı Spot	Product Description	Recessed Downlight
Gövde	Alüminyum Enjeksiyon	Body	Die-Cast Aluminum
Boya	Elektrostatik Toz Boya	Paint	Electrostatic Powder Coated
PCB		PCB	
Lens		Lens	
Reflektör	Yüksek Safılıkta Alüminyum	Reflector	High Purity Aluminum
Difüzör	Temperli Cam	Diffuser	Tempered Glass
SDCM (MacAdam)	3	SDCM (MacAdam)	3
Renk Sıcaklığı	2700K/3000K/4000K	Colour Temperature	2700K/3000K/4000K
Ömür	50000h	Life Time	50000h
Çalışma Sıcaklığı	25°C	Operating Temperature	25°C
LED	Osram/Tridonic/Nichia/Samsung/Cree	LED	Osram/Tridonic/Nichia/Samsung/Cree
Sürücü		Driver	
Uygunluk	EN 60598-1 EN 60598-2-2	Conformity	EN 60598-1 EN 60598-2-2



Ürün Kodu Product Code	Güç Power	Çıkış Işık Akısı Lumen Output	Verimlilik Efficiency	Işık Açısı Beam Angle	Işık Kaynağı Light Source	CRI	Ø (mm)	CUT (mm)	H (mm)
21291	20W	1774Lm	89Lm/W	15°/30°/45°	LED	80	180	170	72
21292	30W	2938Lm	93Lm/W	15°/30°/45°	LED	80	180	170	72





ÜRÜN ÖZELLİKLERİ/PRODUCT SPECIFICATIONS

Ürün Tanımı	Sıva Altı Spot	Product Description	Recessed Downlight
Gövde	Alüminyum Enjeksiyon	Body	Die-Cast Aluminum
Boya	Elektrostatik Toz Boya	Paint	Electrostatic Powder Coated
PCB		PCB	
Lens		Lens	
Reflektör	Yüksek Safılıkta Alüminyum	Reflector	High Purity Aluminum
Difüzör	Temperli Cam	Diffuser	Tempered Glass
SDCM (MacAdam)	3	SDCM (MacAdam)	3
Renk Sıcaklığı	2700K/3000K/4000K	Colour Temperature	2700K/3000K/4000K
Ömür	50000h	Life Time	50000h
Çalışma Sıcaklığı	25°C	Operating Temperature	25°C
LED	Osram/Samsung	LED	Osram/Samsung
Sürücü		Driver	
Uygunluk	EN 60598-1 EN 60598-2-2	Conformity	EN 60598-1 EN 60598-2-2



Ürün Kodu Product Code	Güç Power	Çıkış Işık Akısı Lumen Output	Verimlilik Efficiency	Işık Açısı Beam Angle	Işık Kaynağı Light Source	CRI	Ø (mm)	CUT (mm)	H (mm)
21022	15W	1455Lm	97Lm/W	15°/30°/45°/60°	LED	80	190	170	98
21023	20W	1940Lm	97Lm/W	15°/30°/45°/60°	LED	80	190	170	98
21150	25W	2425Lm	97Lm/W	15°/30°/45°/60°	LED	80	190	170	98
21024	30W	2790Lm	93Lm/W	15°/30°/45°/60°	LED	80	190	170	98
21025	35W	3256Lm	93Lm/W	15°/30°/45°/60°	LED	80	190	170	98



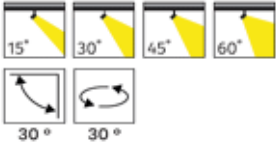

ÜRÜN ÖZELLİKLERİ/PRODUCT SPECIFICATIONS

Ürün Tanımı	Sıva Altı Spot	Product Description	Recessed Downlight
Gövde	Alüminyum Enjeksiyon	Body	Die-Cast Aluminum
Boya	Elektrostatik Toz Boya	Paint	Electrostatic Powder Coated
PCB		PCB	
Lens		Lens	
Reflektör	Yüksek Safılıkta Alüminyum	Reflector	High Purity Aluminum
Difüzör	Temperli Cam	Diffuser	Tempered Glass
SDCM (MacAdam)	3	SDCM (MacAdam)	3
Renk Sıcaklığı	2700K/3000K/4000K	Colour Temperature	2700K/3000K/4000K
Ömür	50000h	Life Time	50000h
Çalışma Sıcaklığı	25°C	Operating Temperature	25°C
LED	Osram/Samsung	LED	Osram/Samsung
Sürücü		Driver	
Uygunluk	EN 60598-1 EN 60598-2-2	Conformity	EN 60598-1 EN 60598-2-2

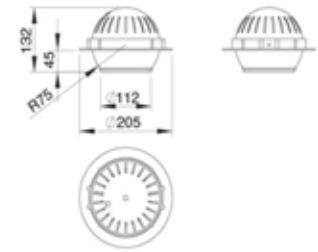

Ürün Kodu Product Code	Güç Power	Çıkış Işık Akısı Lumen Output	Verimlilik Efficiency	Işık Açısı Beam Angle	Işık Kaynağı Light Source	CRI	Ø (mm)	CUT (mm)	H (mm)
21026	15W	1455Lm	97Lm/W	15°/30°/45°/60°	LED	80	205	175	132
21027	20W	1940Lm	97Lm/W	15°/30°/45°/60°	LED	80	205	175	132
21151	25W	2425Lm	97Lm/W	15°/30°/45°/60°	LED	80	205	175	132
21028	30W	2790Lm	93Lm/W	15°/30°/45°/60°	LED	80	205	175	132



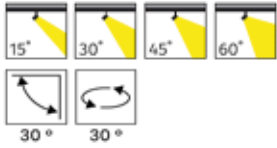

ÜRÜN ÖZELLİKLERİ/PRODUCT SPECIFICATIONS

Ürün Tanımı	Sıva Altı Spot	Product Description	Recessed Downlight
Gövde	Alüminyum Enjeksiyon	Body	Die-Cast Aluminum
Boya	Elektrostatik Toz Boya	Paint	Electrostatic Powder Coated
PCB		PCB	
Lens		Lens	
Reflektör	Yüksek Safılıkta Alüminyum	Reflector	High Purity Aluminum
Difüzör	Temperli Cam	Diffuser	Tempered Glass
SDCM (MacAdam)	3	SDCM (MacAdam)	3
Renk Sıcaklığı	2700K/3000K/4000K	Colour Temperature	2700K/3000K/4000K
Ömür	50000h	Life Time	50000h
Çalışma Sıcaklığı	25°C	Operating Temperature	25°C
LED	Osram/Samsung	LED	Osram/Samsung
Sürücü		Driver	
Uygunluk	EN 60598-1 EN 60598-2-2	Conformity	EN 60598-1 EN 60598-2-2

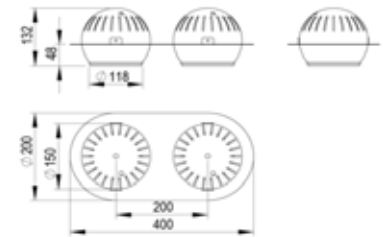

Ürün Kodu Product Code	Güç Power	Çıkış Işık Akısı Lumen Output	Verimlilik Efficiency	Işık Açısı Beam Angle	Işık Kaynağı Light Source	CRI	LxW (mm)	CUT (mm)	H (mm)
23037	2x15W	2x1455Lm	97Lm/W	15°/30°/45°/60°	LED	80	400x200	360x175	132
23010	2x20W	2x1940Lm	97Lm/W	15°/30°/45°/60°	LED	80	400x200	360x175	132
23011	2x25W	2x2425Lm	97Lm/W	15°/30°/45°/60°	LED	80	400x200	360x175	132
23012	2x30W	2x2790Lm	93Lm/W	15°/30°/45°/60°	LED	80	400x200	360x175	132
23013	2x35W	2x3256Lm	93Lm/W	15°/30°/45°/60°	LED	80	400x200	360x175	132



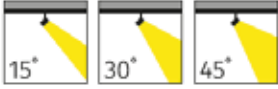

ÜRÜN ÖZELLİKLERİ/PRODUCT SPECIFICATIONS

Ürün Tanımı	Sıva Altı Spot	Product Description	Recessed Downlight
Gövde	Alüminyum Enjeksiyon	Body	Die-Cast Aluminum
Boya	Elektrostatik Toz Boya	Paint	Electrostatic Powder Coated
PCB		PCB	
Lens		Lens	
Reflektör	Yüksek Safılıkta Alüminyum	Reflector	High Purity Aluminum
Difüzör	Temperli Cam	Diffuser	Tempered Glass
SDCM (MacAdam)	3	SDCM (MacAdam)	3
Renk Sıcaklığı	2700K/3000K/4000K	Colour Temperature	2700K/3000K/4000K
Ömür	50000h	Life Time	50000h
Çalışma Sıcaklığı	25°C	Operating Temperature	25°C
LED	Osram/Samsung	LED	Osram/Samsung
Sürücü		Driver	
Uygunluk	EN 60598-1 EN 60598-2-2	Conformity	EN 60598-1 EN 60598-2-2

Ürün Kodu Product Code	Güç Power	Çıkış Işık Akısı Lumen Output	Verimlilik Efficiency	Işık Açısı Beam Angle	Işık Kaynağı Light Source	CRI	LxW (mm)	CUT (mm)	H (mm)
21351	15W	1455Lm	97Lm/W	15°/30°/45°	LED	80	125X125	100X100	87
21352	20W	1940Lm	97Lm/W	15°/30°/45°	LED	80	125X125	100X100	87
21353	25W	2425Lm	97Lm/W	15°/30°/45°	LED	80	125X125	100X100	87



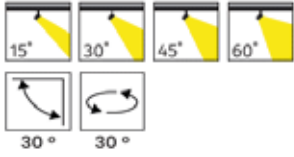

ÜRÜN ÖZELLİKLERİ/PRODUCT SPECIFICATIONS

Ürün Tanımı	Sıva Altı Spot	Product Description	Recessed Downlight
Gövde	Alüminyum Enjeksiyon	Body	Die-Cast Aluminum
Boya	Elektrostatik Toz Boya	Paint	Electrostatic Powder Coated
PCB		PCB	
Lens		Lens	
Reflektör	Yüksek Safılıkta Alüminyum	Reflector	High Purity Aluminum
Difüzör	Temperli Cam	Diffuser	Tempered Glass
SDCM (MacAdam)	3	SDCM (MacAdam)	3
Renk Sıcaklığı	2700K/3000K/4000K	Colour Temperature	2700K/3000K/4000K
Ömür	50000h	Life Time	50000h
Çalışma Sıcaklığı	25°C	Operating Temperature	25°C
LED	Osram/Samsung	LED	Osram/Samsung
Sürücü		Driver	
Uygunluk	EN 60598-1 EN 60598-2-2	Conformity	EN 60598-1 EN 60598-2-2

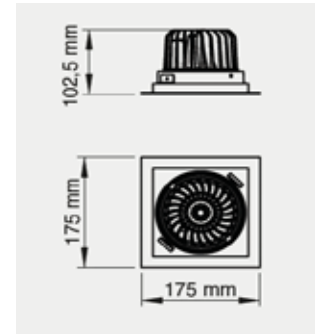

Ürün Kodu Product Code	Güç Power	Çıkış Işık Akısı Lumen Output	Verimlilik Efficiency	Işık Açısı Beam Angle	Işık Kaynağı Light Source	CRI	LxW (mm)	CUT (mm)	H (mm)
21032	15W	1455Lm	97Lm/W	15°/30°/45°/60°	LED	80	175x175	155x155	102,5
21033	20W	1940Lm	97Lm/W	15°/30°/45°/60°	LED	80	175x175	155x155	102,5
21154	25W	2425Lm	97Lm/W	15°/30°/45°/60°	LED	80	175x175	155x155	102,5
21034	30W	2910Lm	97Lm/W	15°/30°/45°/60°	LED	80	175x175	155x155	102,5
21035	35W	3256Lm	93Lm/W	15°/30°/45°/60°	LED	80	175x175	155x155	102,5



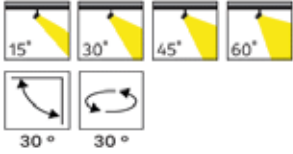

ÜRÜN ÖZELLİKLERİ/PRODUCT SPECIFICATIONS

Ürün Tanımı	Sıva Altı Spot	Product Description	Recessed Downlight
Gövde	Alüminyum Enjeksiyon	Body	Die-Cast Aluminum
Boya	Elektrostatik Toz Boya	Paint	Electrostatic Powder Coated
PCB		PCB	
Lens		Lens	
Reflektör	Yüksek Safılıkta Alüminyum	Reflector	High Purity Aluminum
Difüzör	Temperli Cam	Diffuser	Tempered Glass
SDCM (MacAdam)	3	SDCM (MacAdam)	3
Renk Sıcaklığı	2700K/3000K/4000K	Colour Temperature	2700K/3000K/4000K
Ömür	50000h	Life Time	50000h
Çalışma Sıcaklığı	25°C	Operating Temperature	25°C
LED	Osram/Samsung	LED	Osram/Samsung
Sürücü		Driver	
Uygunluk	EN 60598-1 EN 60598-2-2	Conformity	EN 60598-1 EN 60598-2-2

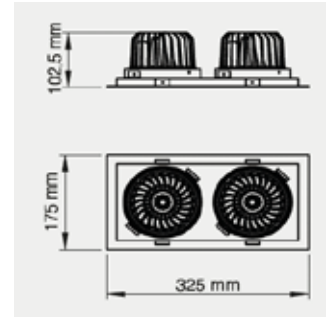

Ürün Kodu Product Code	Güç Power	Çıkış Işık Akısı Lumen Output	Verimlilik Efficiency	Işık Açısı Beam Angle	Işık Kaynağı Light Source	CRI	LxW (mm)	CUT (mm)	H (mm)
23019	2x15W	2x1455Lm	97Lm/W	15°/30°/45°/60°	LED	80	325x175	305x155	102,5
23020	2x20W	2x1940Lm	97Lm/W	15°/30°/45°/60°	LED	80	325x175	305x155	102,5
23021	2x25W	2x2425Lm	97Lm/W	15°/30°/45°/60°	LED	80	325x175	305x155	102,5
23022	2x30W	2x2938Lm	97Lm/W	15°/30°/45°/60°	LED	80	325x175	305x155	102,5
23023	2x35W	2x3256Lm	93Lm/W	15°/30°/45°/60°	LED	80	325x175	305x155	102,5



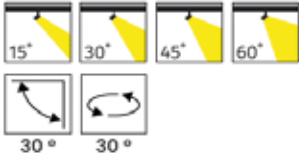

ÜRÜN ÖZELLİKLERİ/PRODUCT SPECIFICATIONS

Ürün Tanımı	Sıva Altı Spot	Product Descripton	Recessed Downlight
Gövde	Alüminyum Enjeksiyon	Body	Die-Cast Aluminum
Boya	Elektrostatik Toz Boya	Paint	Electrostatic Powder Coated
PCB		PCB	
Lens		Lens	
Reflektör	Yüksek Safılıkta Alüminyum	Reflector	High Purity Aluminum
Difüzör	Temperli Cam	Diffuser	Tempered Glass
SDCM (MacAdam)	3	SDCM (MacAdam)	3
Renk Sıcaklığı	2700K/3000K/4000K	Colour Temperature	2700K/3000K/4000K
Ömür	50000h	Life Time	50000h
Çalışma Sıcaklığı	25°C	Operating Temperature	25°C
LED	Osram/Samsung	LED	Osram/Samsung
Sürücü		Driver	
Uygunluk	EN 60598-1 EN 60598-2-2	Conformity	EN 60598-1 EN 60598-2-2

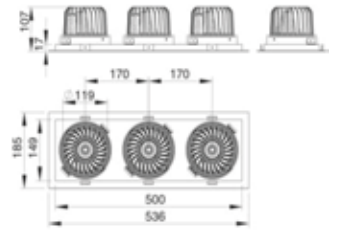
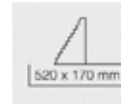

Ürün Kodu Product Code	Güç Power	Çıkış Işık Akısı Lumen Output	Verimlilik Efficiency	Işık Açısı Beam Angle	Işık Kaynağı Light Source	CRI	LxW (mm)	CUT (mm)	H (mm)
24014	3x15W	3x1455Lm	97Lm/W	15°/30°/45°/60°	LED	80	536x185	520x170	107
24015	3x20W	3x1940Lm	97Lm/W	15°/30°/45°/60°	LED	80	536x185	520x170	107
24016	3x25W	3x2425Lm	97Lm/W	15°/30°/45°/60°	LED	80	536x185	520x170	107
24017	3x30W	3x2938Lm	97Lm/W	15°/30°/45°/60°	LED	80	536x185	520x170	107
24018	3x35W	3x3256Lm	93Lm/W	15°/30°/45°/60°	LED	80	536x185	520x170	107



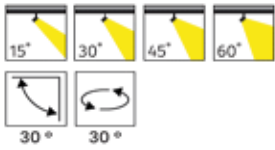

ÜRÜN ÖZELLİKLERİ/PRODUCT SPECIFICATIONS

Ürün Tanımı	Sıva Altı Spot	Product Description	Recessed Downlight
Gövde	Alüminyum Enjeksiyon	Body	Die-Cast Aluminum
Boya	Elektrostatik Toz Boya	Paint	Electrostatic Powder Coated
PCB		PCB	
Lens		Lens	
Reflektör	Yüksek Safılıkta Alüminyum	Reflector	High Purity Aluminum
Difüzör	Temperli Cam	Diffuser	Tempered Glass
SDCM (MacAdam)	3	SDCM (MacAdam)	3
Renk Sıcaklığı	2700K/3000K/4000K	Colour Temperature	2700K/3000K/4000K
Ömür	50000h	Life Time	50000h
Çalışma Sıcaklığı	25°C	Operating Temperature	25°C
LED	Osram/Samsung	LED	Osram/Samsung
Sürücü		Driver	
Uygunluk	EN 60598-1 EN 60598-2-2	Conformity	EN 60598-1 EN 60598-2-2

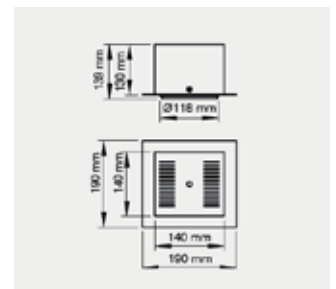

Ürün Kodu Product Code	Güç Power	Çıkış Işık Akısı Lumen Output	Verimlilik Efficiency	Işık Açısı Beam Angle	Işık Kaynağı Light Source	CRI	LxW (mm)	CUT (mm)	H (mm)
21152	15W	1455Lm	97Lm/W	15°/30°/45°/60°	LED	80	190x190	160x160	139
21029	20W	1455Lm	97Lm/W	15°/30°/45°/60°	LED	80	190x190	160x160	139
21153	25W	2425Lm	97Lm/W	15°/30°/45°/60°	LED	80	190x190	160x160	139
21030	30W	2938Lm	97Lm/W	15°/30°/45°/60°	LED	80	190x190	160x160	139
21031	35W	3256Lm	97Lm/W	15°/30°/45°/60°	LED	80	190x190	160x160	139



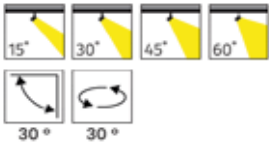

ÜRÜN ÖZELLİKLERİ/PRODUCT SPECIFICATIONS

Ürün Tanımı	Sıva Altı Spot	Product Description	Recessed Downlight
Gövde	Alüminyum Enjeksiyon	Body	Die-Cast Aluminum
Boya	Elektrostatik Toz Boya	Paint	Electrostatic Powder Coated
PCB		PCB	
Lens		Lens	
Reflektör	Yüksek Safılıkta Alüminyum	Reflector	High Purity Aluminum
Difüzör	Temperli Cam	Diffuser	Tempered Glass
SDCM (MacAdam)	3	SDCM (MacAdam)	3
Renk Sıcaklığı	2700K/3000K/4000K	Colour Temperature	2700K/3000K/4000K
Ömür	50000h	Life Time	50000h
Çalışma Sıcaklığı	25°C	Operating Temperature	25°C
LED	Osram/Samsung	LED	Osram/Samsung
Sürücü		Driver	
Uygunluk	EN 60598-1 EN 60598-2-2	Conformity	EN 60598-1 EN 60598-2-2

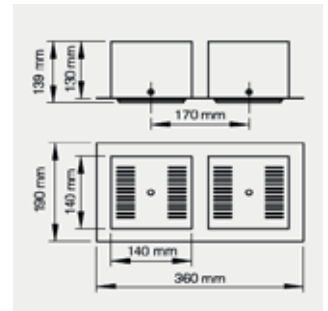

Ürün Kodu Product Code	Güç Power	Çıkış Işık Akısı Lumen Output	Verimlilik Efficiency	Işık Açısı Beam Angle	Işık Kaynağı Light Source	CRI	LxW (mm)	CUT (mm)	H (mm)
23014	2x15W	2x1455Lm	97Lm/W	15°/30°/45°/60°	LED	80	360x190	330x160	139
23015	2x20W	2x1940Lm	97Lm/W	15°/30°/45°/60°	LED	80	360x190	330x160	139
23016	2x25W	2x2425Lm	97Lm/W	15°/30°/45°/60°	LED	80	360x190	330x160	139
23017	2x30W	2x2938Lm	97Lm/W	15°/30°/45°/60°	LED	80	360x190	330x160	139
23018	2x35W	2x3256Lm	93Lm/W	15°/30°/45°/60°	LED	80	360x190	330x160	139





ÜRÜN ÖZELLİKLERİ/PRODUCT SPECIFICATIONS

Ürün Tanımı	Sıva Altı Spot	Product Description	Recessed Downlight
Gövde	Alüminyum Enjeksiyon	Body	Die-Cast Aluminum
Boya	Elektrostatik Toz Boya	Paint	Electrostatic Powder Coated
PCB		PCB	
Lens		Lens	
Reflektör	Yüksek Safılıkta Alüminyum	Reflector	High Purity Aluminum
Difüzör	Temperli Cam	Diffuser	Tempered Glass
SDCM (MacAdam)	3	SDCM (MacAdam)	3
Renk Sıcaklığı	2700K/3000K/4000K	Colour Temperature	2700K/3000K/4000K
Ömür	50000h	Life Time	50000h
Çalışma Sıcaklığı	25°C	Operating Temperature	25°C
LED	Osram/Samsung	LED	Osram/Samsung
Sürücü		Driver	
Uygunluk	EN 60598-1 EN 60598-2-2	Conformity	EN 60598-1 EN 60598-2-2

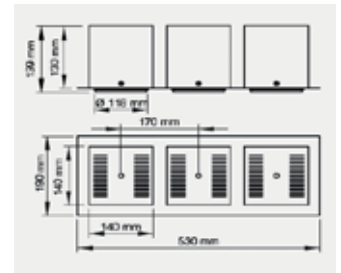

Ürün Kodu Product Code	Güç Power	Çıkış Işık Akısı Lumen Output	Verimlilik Efficiency	Işık Açısı Beam Angle	Işık Kaynağı Light Source	CRI	LxW (mm)	CUT (mm)	H (mm)
24009	3x15W	3x1455Lm	97Lm/W	15°/30°/45°/60°	LED	80	530x190	500x160	139
24010	3x20W	3x1940Lm	97Lm/W	15°/30°/45°/60°	LED	80	530x190	500x160	139
24011	3x25W	3x2425Lm	97Lm/W	15°/30°/45°/60°	LED	80	530x190	500x160	139
24012	3x30W	3x2938Lm	97Lm/W	15°/30°/45°/60°	LED	80	530x190	500x160	139
24012	3x35W	3x3256Lm	93Lm/W	15°/30°/45°/60°	LED	80	530x190	500x160	139



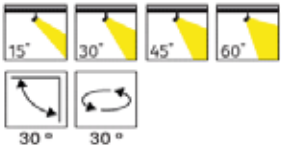

ÜRÜN ÖZELLİKLERİ/PRODUCT SPECIFICATIONS

Ürün Tanımı	Sıva Altı Spot	Product Description	Recessed Downlight
Gövde	Alüminyum Enjeksiyon	Body	Die-Cast Aluminum
Boya	Elektrostatik Toz Boya	Paint	Electrostatic Powder Coated
PCB		PCB	
Lens		Lens	
Reflektör	Yüksek Safılıkta Alüminyum	Reflector	High Purity Aluminum
Difüzör	Temperli Cam	Diffuser	Tempered Glass
SDCM (MacAdam)	3	SDCM (MacAdam)	3
Renk Sıcaklığı	2700K/3000K/4000K	Colour Temperature	2700K/3000K/4000K
Ömür	50000h	Life Time	50000h
Çalışma Sıcaklığı	25°C	Operating Temperature	25°C
LED	Osram/Samsung	LED	Osram/Samsung
Sürücü		Driver	
Uygunluk	EN 60598-1 EN 60598-2-2	Conformity	EN 60598-1 EN 60598-2-2

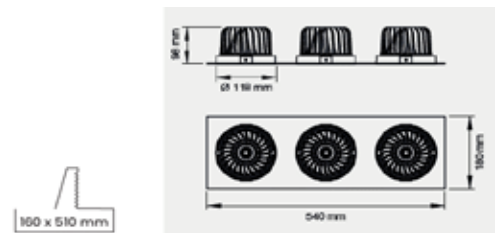

Ürün Kodu Product Code	Güç Power	Çıkış Işık Akısı Lumen Output	Verimlilik Efficiency	Işık Açısı Beam Angle	Işık Kaynağı Light Source	CRI	LxW (mm)	CUT (mm)	H (mm)
24032	3x15W	3x1455Lm	97Lm/W	15°/30°/45°/60°	LED	80	540x180	510x160	98
24001	3x20W	3x1940Lm	97Lm/W	15°/30°/45°/60°	LED	80	540x180	510x160	98
24002	3x25W	3x2425Lm	97Lm/W	15°/30°/45°/60°	LED	80	540x180	510x160	98
24003	3x30W	3x2938Lm	97Lm/W	15°/30°/45°/60°	LED	80	540x180	510x160	98
24004	3x35W	3x3256Lm	93Lm/W	15°/30°/45°/60°	LED	80	540x180	510x160	98



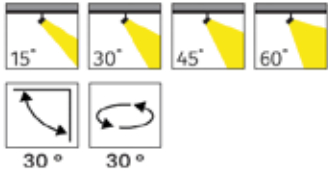

ÜRÜN ÖZELLİKLERİ/PRODUCT SPECIFICATIONS

Ürün Tanımı	Sıva Altı Spot	Product Description	Recessed Downlight
Gövde	Alüminyum Enjeksiyon	Body	Die-Cast Aluminum
Boya	Elektrostatik Toz Boya	Paint	Electrostatic Powder Coated
PCB		PCB	
Lens		Lens	
Reflektör	Yüksek Safılıkta Alüminyum	Reflector	High Purity Aluminum
Difüzör	Temperli Cam	Diffuser	Tempered Glass
SDCM (MacAdam)	3	SDCM (MacAdam)	3
Renk Sıcaklığı	2700K/3000K/4000K	Colour Temperature	2700K/3000K/4000K
Ömür	50000h	Life Time	50000h
Çalışma Sıcaklığı	25°C	Operating Temperature	25°C
LED	Osram/Samsung	LED	Osram/Samsung
Sürücü		Driver	
Uygunluk	EN 60598-1 EN 60598-2-2	Conformity	EN 60598-1 EN 60598-2-2

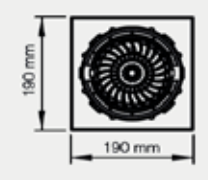

Ürün Kodu Product Code	Güç Power	Çıkış Işık Akısı Lumen Output	Verimlilik Efficiency	Işık Açısı Beam Angle	Işık Kaynağı Light Source	CRI	LxW (mm)	CUT (mm)	H (mm)
21018	15W	1455Lm	97Lm/W	15°/30°/45°/60°	LED	80	190x190	170x170	98
21019	20W	1940Lm	97Lm/W	15°/30°/45°/60°	LED	80	190x190	170x170	98
21149	25W	2425Lm	97Lm/W	15°/30°/45°/60°	LED	80	190x190	170x170	98
21020	30W	2938Lm	97Lm/W	15°/30°/45°/60°	LED	80	190x190	170x170	98
21021	35W	3256Lm	93Lm/W	15°/30°/45°/60°	LED	80	190x190	170x170	98



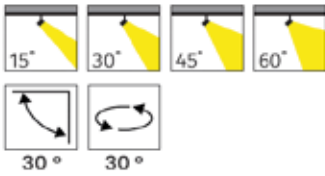

ÜRÜN ÖZELLİKLERİ/PRODUCT SPECIFICATIONS

Ürün Tanımı	Sıva Altı Spot	Product Description	Recessed Downlight
Gövde	Alüminyum Enjeksiyon	Body	Die-Cast Aluminum
Boya	Elektrostatik Toz Boya	Paint	Electrostatic Powder Coated
PCB		PCB	
Lens		Lens	
Reflektör	Yüksek Safılıkta Alüminyum	Reflector	High Purity Aluminum
Difüzör	Temperli Cam	Diffuser	Tempered Glass
SDCM (MacAdam)	3	SDCM (MacAdam)	3
Renk Sıcaklığı	2700K/3000K/4000K	Colour Temperature	2700K/3000K/4000K
Ömür	50000h	Life Time	50000h
Çalışma Sıcaklığı	25°C	Operating Temperature	25°C
LED	Osram/Samsung	LED	Osram/Samsung
Sürücü		Driver	
Uygunluk	EN 60598-1 EN 60598-2-2	Conformity	EN 60598-1 EN 60598-2-2

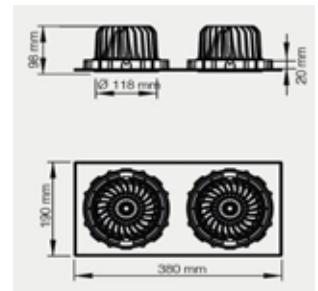

Ürün Kodu Product Code	Güç Power	Çıkış Işık Akısı Lumen Output	Verimlilik Efficiency	Işık Açısı Beam Angle	Işık Kaynağı Light Source	CRI	LxW (mm)	CUT (mm)	H (mm)
23036	2x15W	2x1455Lm	97Lm/W	15°/30°/45°/60°	LED	80	380x190	170x360	98
23006	2x20W	2x1940Lm	97Lm/W	15°/30°/45°/60°	LED	80	380x190	170x360	98
23007	2x25W	2x2425Lm	97Lm/W	15°/30°/45°/60°	LED	80	380x190	170x360	98
23008	2x30W	2x2938Lm	97Lm/W	15°/30°/45°/60°	LED	80	380x190	170x360	98
23009	2x35W	2x3256Lm	93Lm/W	15°/30°/45°/60°	LED	80	380x190	170x360	98





ÜRÜN ÖZELLİKLERİ/PRODUCT SPECIFICATIONS

Ürün Tanımı	Sıva Altı Spot	Product Description	Recessed Downlight
Gövde	Alüminyum Enjeksiyon	Body	Die-Cast Aluminum
Boya	Elektrostatik Toz Boya	Paint	Electrostatic Powder Coated
PCB		PCB	
Lens		Lens	
Reflektör	Yüksek Safılıkta Alüminyum	Reflector	High Purity Aluminum
Difüzör	Temperli Cam	Diffuser	Tempered Glass
SDCM (MacAdam)	3	SDCM (MacAdam)	3
Renk Sıcaklığı	2700K/3000K/4000K	Colour Temperature	2700K/3000K/4000K
Ömür	50000h	Life Time	50000h
Çalışma Sıcaklığı	25°C	Operating Temperature	25°C
LED	Osram/Samsung	LED	Osram/Samsung
Sürücü		Driver	
Uygunluk	EN 60598-1 EN 60598-2-2	Conformity	EN 60598-1 EN 60598-2-2

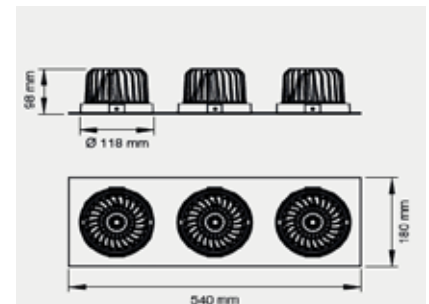

Ürün Kodu Product Code	Güç Power	Çıkış Işık Akısı Lumen Output	Verimlilik Efficiency	Işık Açısı Beam Angle	Işık Kaynağı Light Source	CRI	LxW (mm)	CUT (mm)	H (mm)
24028	90W	8814Lm	98Lm/W	15°/30°/45°/60°	LED	80	540x180	160x510	98
24029	105W	9768Lm	93Lm/W	15°/30°/45°/60°	LED	80	540x180	160x510	98



Sıva Altı GU10 Spot



Recessed GU10 Spot



ÜRÜN ÖZELLİKLERİ/PRODUCT SPECIFICATIONS

Ürün Tanımı	Siva Altı Spot	Product Description	Recessed Spotlight
Gövde	Alüminyum Buzlu Cam	Body	Aluminum Housing Frosted Glass
Boya	Elektrostatik Toz Boya	Paint	Elektrostatic Powder Coated
PCB		PCB	
Lens		Lens	
Reflektör		Reflector	
Difüzör		Diffuser	
SDCM (MacAdam)	3	SDCM (MacAdam)	3
Renk Sıcaklığı	3000K	Colour Temperature	3000K
Ömür	50000h	Life Time	50000h
Çalışma Sıcaklığı	25°C	Operating Temperature	25°C
LED		LED	
Sürücü		Driver	
Uygunluk	EN 60598-1 EN 60598-2-2	Conformity	EN 60598-1 EN 60598-2-2

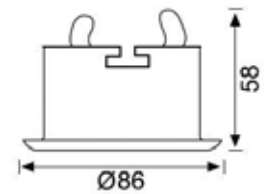

Ürün Kodu Product Code	Güç Power	Çıkış Işık Akısı Lumen Output	Verimlilik Efficiency	Işık Açısı Beam Angle	Işık Kaynağı Light Source	CRI	Ø (mm)	Ø CUT (mm)	H (mm)
63003	5W	350Lm	70Lm/W	35°	GU10	80	86	72	58



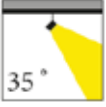

ÜRÜN ÖZELLİKLERİ/PRODUCT SPECIFICATIONS

Ürün Tanımı	Sıva Altı Spot	Product Description	Recessed Spotlight
Gövde	Alüminyum	Body	Aluminum Housing
Boya	Elektrostatik Toz Boya	Paint	Elektrostatic Powder Coated
PCB		PCB	
Lens		Lens	
Reflektör		Reflector	
Difüzör		Diffuser	
SDCM (MacAdam)	3	SDCM (MacAdam)	3
Renk Sıcaklığı	2700K/3000K/4000K	Colour Temperature	2700K/3000K/4000K
Ömür	50000h	Life Time	50000h
Çalışma Sıcaklığı	25°C	Operating Temperature	25°C
LED		LED	
Sürücü		Driver	
Uygunluk	EN 60598-1 EN 60598-2-2	Conformity	EN 60598-1 EN 60598-2-2

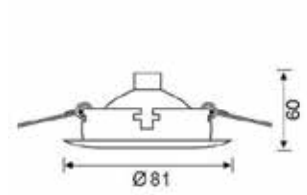

Ürün Kodu Product Code	Güç Power	Çıkış Işık Akısı Lumen Output	Verimlilik Efficiency	Işık Açısı Beam Angle	Işık Kaynağı Light Source	CRI	Ø (mm)	CUT (mm)	H (mm)
21065	5W	350lm	70lm/W	35°	GU10	80	81	68	60



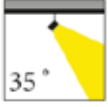

ÜRÜN ÖZELLİKLERİ/PRODUCT SPECIFICATIONS

Ürün Tanımı	Sıva Altı Spot	Product Description	Recessed Downlight
Gövde	Alüminyum Enjeksiyon	Body	Die-Cast Aluminum Housing
Boya	Önden Ampul Değişirme	Paint	Bulb Replacable From Front
PCB		PCB	
Lens		Lens	
Reflektör		Reflector	
Difüzör		Diffuser	
SDCM (MacAdam)	3	SDCM (MacAdam)	3
Renk Sıcaklığı	2700K/3000K/4000K	Colour Temperature	2700K/3000K/4000K
Ömür	50000h	Life Time	50000h
Çalışma Sıcaklığı	25°C	Operating Temperature	25°C
LED		LED	
Sürücü		Driver	
Uygunluk	EN 60598-1 EN 60598-2-2	Conformity	EN 60598-1 EN 60598-2-2

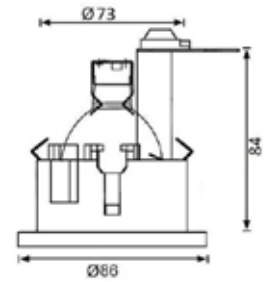

Ürün Kodu Product Code	Güç Power	Çıkış Işık Akısı Lumen Output	Verimlilik Efficiency	Işık Açısı Beam Angle	Işık Kaynağı Light Source	CRI	Ø (mm)	CUT (mm)	H (mm)
21078	5W	350Lm	70Lm/W	35°	GU10	80	86	73	84



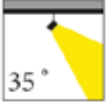

ÜRÜN ÖZELLİKLERİ/PRODUCT SPECIFICATIONS

Ürün Tanımı	Sıva Altı Spot	Product Description	Recessed Downlight
Gövde	Alüminyum	Body	Aluminum
Boya		Paint	
PCB		PCB	
Lens		Lens	
Reflektör	Plastik	Reflector	Plastic
Difüzör		Diffuser	
SDCM (MacAdam)	6	SDCM (MacAdam)	6
Renk Sıcaklığı	2700K	Colour Temperature	2700K
Ömür	15000h	Life Time	15000h
Çalışma Sıcaklığı	25°C	Operating Temperature	25°C
LED		LED	
Sürücü		Driver	
Uygunluk	EN 60598-1 EN 60598-2-2	Conformity	EN 60598-1 EN 60598-2-2

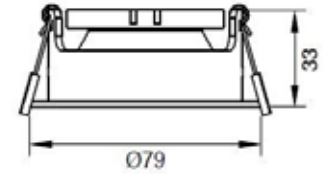

Ürün Kodu Product Code	Güç Power	Çıkış Işık Akısı Lumen Output	Verimlilik Efficiency	Işık Açısı Beam Angle	Işık Kaynağı Light Source	CRI	Ø (mm)	CUT (mm)	H (mm)
21072	5W	350Lm	70Lm/W	35°	GU10	80	79	72	33





ÜRÜN ÖZELLİKLERİ/PRODUCT SPECIFICATIONS

Ürün Tanımı	Sıva Altı Hareketli Spot	Product Description	Recessed Adjustable Downlight
Gövde	Alüminyum	Body	Aluminum Housing
Boya	Elektrostatik Toz Boya	Paint	Electrostatic Powder Coated
PCB		PCB	
Lens		Lens	
Reflektör		Reflector	
Difüzör		Diffuser	
SDCM (MacAdam)	3	SDCM (MacAdam)	3
Renk Sıcaklığı	2700K/3000K/4000K	Colour Temperature	2700K/3000K/4000K
Ömür	50000h	Life Time	50000h
Çalışma Sıcaklığı	25°C	Operating Temperature	25°C
LED		LED	
Sürücü		Driver	
Uygunluk	EN 60598-1 EN 60598-2-2	Conformity	EN 60598-1 EN 60598-2-2

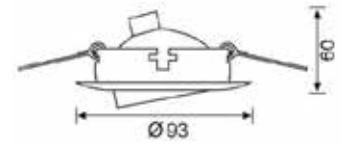

Ürün Kodu Product Code	Güç Power	Çıkış Işık Akısı Lumen Output	Verimlilik Efficiency	Işık Açısı Beam Angle	Işık Kaynağı Light Source	CRI	Ø (mm)	CUT (mm)	H (mm)
21066	5W	350Lm	70Lm/W	35°	GU10	80	93	80	60





1



2



3



4



ÜRÜN ÖZELLİKLERİ/PRODUCT SPECIFICATIONS

Ürün Tanımı	Sıva Altı Hareketli Spot	Product Descripton	Recessed Adjustable Downlight
Gövde	Elektrostatik Toz Boya	Body	Elektrostatik Powder Coated
Boya		Paint	
PCB		PCB	
Lens		Lens	
Reflektör		Reflector	
Difüzör		Diffuser	
SDCM (MacAdam)	3	SDCM (MacAdam)	3
Renk Sıcaklığı	2700K/3000K/4000K	Colour Temperature	2700K/3000K/4000K
Ömür	50000h	Life Time	50000h
Çalışma Sıcaklığı	25°C	Operating Temperature	25°C
LED		LED	
Sürücü		Driver	
Uygunluk	EN 60598-1 EN 60598-2-2	Conformity	EN 60598-1 EN 60598-2-2

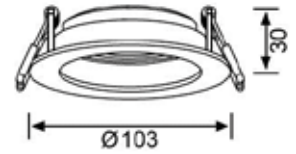

Ürün Kodu Product Code	Güç Power	Çıkış Işık Akısı Lumen Output	Verimlilik Efficiency	Işık Açısı Beam Angle	Işık Kaynağı Light Source	CRI	Ø (mm)	CUT (mm)	H (mm)
21067-X	5W	350Lm	70Lm/W	35°	GU10	80	103	85	30





ÜRÜN ÖZELLİKLERİ/PRODUCT SPECIFICATIONS

Ürün Tanımı	Sıva Altı Hareketli Spot	Product Description	Recessed Adjustable Downlight
Gövde	Alüminyum Enjeksiyon	Body	Die-Cast Aluminum
Boya		Paint	
PCB		PCB	
Lens		Lens	
Reflektör		Reflector	
Difüzör		Diffuser	
SDCM (MacAdam)	3	SDCM (MacAdam)	3
Renk Sıcaklığı	2700K/3000K/4000K	Colour Temperature	2700K/3000K/4000K
Ömür	50000h	Life Time	50000h
Çalışma Sıcaklığı	25°C	Operating Temperature	25°C
LED		LED	
Sürücü		Driver	
Uygunluk	EN 60598-1 EN 60598-2-2	Conformity	EN 60598-1 EN 60598-2-2

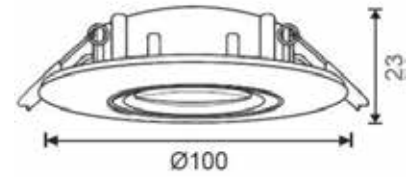

Ürün Kodu Product Code	Güç Power	Çıkış Işık Akısı Lumen Output	Verimlilik Efficiency	Işık Açısı Beam Angle	Işık Kaynağı Light Source	CRI	Ø (mm)	CUT (mm)	H (mm)
21159	5W	350lm	70lm/W	35°	GU10	80	100	75	23





ÜRÜN ÖZELLİKLERİ/PRODUCT SPECIFICATIONS

Ürün Tanımı	Sıva Altı Hareketli Spot	Product Description	Recessed Adjustable Downlight
Gövde	Alüminyum Enjeksiyon	Body	Die-Cast Aluminum
Boya		Paint	
PCB		PCB	
Lens		Lens	
Reflektör		Reflector	
Difüzör		Diffuser	
SDCM (MacAdam)	3	SDCM (MacAdam)	3
Renk Sıcaklığı	2700K/3000K/4000K	Colour Temperature	2700K/3000K/4000K
Ömür	50000h	Life Time	50000h
Çalışma Sıcaklığı	25°C	Operating Temperature	25°C
LED		LED	
Sürücü		Driver	
Uygunluk	EN 60598-1 EN 60598-2-2	Conformity	EN 60598-1 EN 60598-2-2

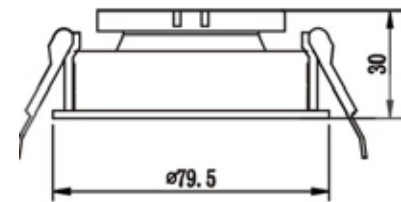

Ürün Kodu Product Code	Güç Power	Çıkış Işık Akısı Lumen Output	Verimlilik Efficiency	Işık Açısı Beam Angle	Işık Kaynağı Light Source	CRI	Ø (mm)	CUT (mm)	H (mm)
21289 B	5W	350Lm	70Lm/W	35°	GU10	80	79	72	30
21290 S	5W	350Lm	70Lm/W	35°	GU10	80	79	72	30



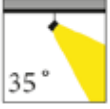

ÜRÜN ÖZELLİKLERİ/PRODUCT SPECIFICATIONS

Ürün Tanımı	Siva Altı Hareketli Spot	Product Descripton	Recessed Adjustable Downlight
Gövde	Elektrostatik Toz Boya	Body	Elektrostatik Powder Coated
Boya		Paint	
PCB		PCB	
Lens		Lens	
Reflektör		Reflector	
Difüzör		Diffuser	
SDCM (MacAdam)	3	SDCM (MacAdam)	3
Renk Sıcaklığı	2700K/3000K/4000K	Colour Temperature	2700K/3000K/4000K
Ömür	50000h	Life Time	50000h
Çalışma Sıcaklığı	25°C	Operating Temperature	25°C
LED		LED	
Sürücü		Driver	
Uygunluk	EN 60598-1 EN 60598-2-2	Conformity	EN 60598-1 EN 60598-2-2

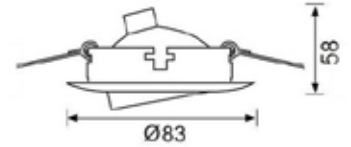

Ürün Kodu Product Code	Güç Power	Çıkış Işık Akısı Lumen Output	Verimlilik Efficiency	Işık Açısı Beam Angle	Işık Kaynağı Light Source	CRI	Ø (mm)	CUT (mm)	H (mm)
21160	5W	350Lm	70Lm/W	35°	GU10	80	83	70	58





ÜRÜN ÖZELLİKLERİ/PRODUCT SPECIFICATIONS

Ürün Tanımı	Siva Alti Spot	Product Descripton	Recessed Downlight
Gövde	Alüminyum	Body	Aluminum
Boya		Paint	
PCB		PCB	
Lens		Lens	
Reflektör	Plastik	Reflector	Plastic
Difüzör		Diffuser	
SDCM (MacAdam)	6	SDCM (MacAdam)	6
Renk Sıcaklığı	2700K	Colour Temperature	2700K
Ömür	15000h	Life Time	15000h
Çalışma Sıcaklığı	25°C	Operating Temperature	25°C
LED		LED	
Sürücü		Driver	
Uygunluk	EN 60598-1 EN 60598-2-2	Conformity	EN 60598-1 EN 60598-2-2

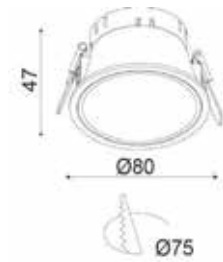

Ürün Kodu Product Code	Güç Power	Çıkış Işık Akısı Lumen Output	Verimlilik Efficiency	Işık Açısı Beam Angle	Işık Kaynağı Light Source	CRI	Ø (mm)	CUT (mm)	H (mm)
21071	5W	350Lm	70Lm/W	35°	GU10	80	80	75	47



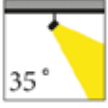

ÜRÜN ÖZELLİKLERİ/PRODUCT SPECIFICATIONS

Ürün Tanımı	Sıva Altı Spot	Product Description	Recessed Downlight
Gövde	Alüminyum Gövde	Body	Aluminum Housing
Boya	Elektrostatik Toz Boya	Paint	Elektrostatic Powder Coated
PCB		PCB	
Lens		Lens	
Reflektör		Reflector	
Difüzör		Diffuser	
SDCM (MacAdam)	3	SDCM (MacAdam)	3
Renk Sıcaklığı	2700K/3000K/4000K	Colour Temperature	2700K/3000K/4000K
Ömür	50000h	Life Time	50000h
Çalışma Sıcaklığı	25°C	Operating Temperature	25°C
LED		LED	
Sürücü		Driver	
Uygunluk	EN 60598-1 EN 60598-2-2	Conformity	EN 60598-1 EN 60598-2-2

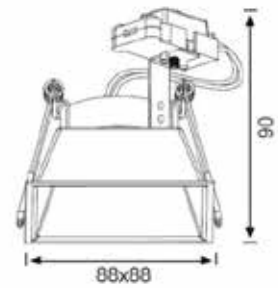

Ürün Kodu Product Code	Güç Power	Çıkış Işık Akısı Lumen Output	Verimlilik Efficiency	Işık Açısı Beam Angle	Işık Kaynağı Light Source	CRI	LxW (mm)	CUT (mm)	H (mm)
21010	5W	350lm	70Lm/W	35°	GU10	80	88x88	75x75	90





21069 GOLD



21070 BLACK



ÜRÜN ÖZELLİKLERİ/PRODUCT SPECIFICATIONS

Ürün Tanımı	Sıva Altı Spot	Product Description	Recessed Downlight
Gövde	Zamak Gövde	Body	Die-Cast Zinc Housing
Boya	Elektrostatik Toz Boya	Paint	Elektrostatic Powder Coated
PCB		PCB	
Lens		Lens	
Reflektör	Altın Renkli Plastik Plastik	Reflector	Plastic In Gold Colour
Difüzör		Diffuser	
SDCM (MacAdam)	3	SDCM (MacAdam)	3
Renk Sıcaklığı	2700K/3000K/4000K	Colour Temperature	2700K/3000K/4000K
Ömür	50000h	Life Time	50000h
Çalışma Sıcaklığı	25°C	Operating Temperature	25°C
LED		LED	
Sürücü		Driver	
Uygunluk	EN 60598-1 EN 60598-2-2	Conformity	EN 60598-1 EN 60598-2-2

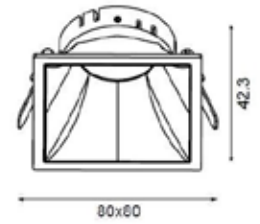

Ürün Kodu Product Code	Güç Power	Çıkış Işık Akısı Lumen Output	Verimlilik Efficiency	Işık Açısı Beam Angle	Işık Kaynağı Light Source	CRI	LxW (mm)	CUT (mm)	H (mm)
21069	5W	350Lm	70Lm/W	35°	GU10	80	80x80	75x75	42,3
21070	5W	350Lm	70Lm/W	35°	GU10	80	80x80	75x75	42,3



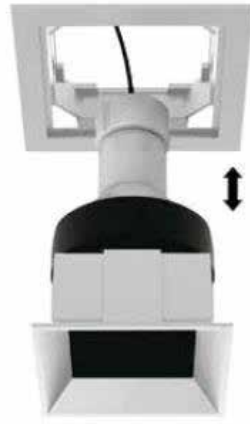
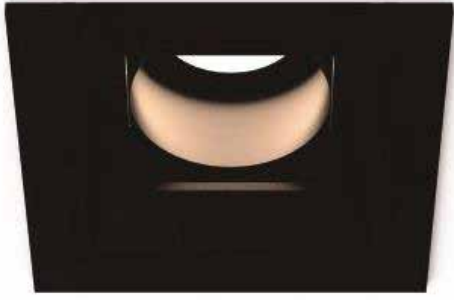

ÜRÜN ÖZELLİKLERİ/PRODUCT SPECIFICATIONS

Ürün Tanımı	Sıva Altı Spot	Product Description	Recessed Downlight
Gövde	Alüminyum Enjeksiyon	Body	Die-Cast Aluminum Housing
Boya	Elektrostatik Toz Boya	Paint	Elektrostatic Powder Coated
PCB		PCB	
Lens		Lens	
Reflektör		Reflector	
Difüzör		Diffuser	
SDCM (MacAdam)	6	SDCM (MacAdam)	6
Renk Sıcaklığı	2700K	Colour Temperature	2700K
Ömür	15000h	Life Time	15000h
Çalışma Sıcaklığı	25°C	Operating Temperature	25°C
LED		LED	
Sürücü		Driver	
Uygunluk	EN 60598-1 EN 60598-2-2	Conformity	EN 60598-1 EN 60598-2-2

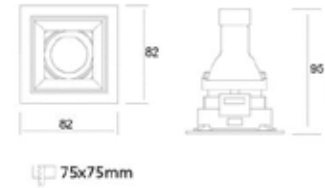

Ürün Kodu Product Code	Güç Power	Çıkış Işık Akısı Lumen Output	Verimlilik Efficiency	Işık Açısı Beam Angle	Işık Kaynağı Light Source	CRI	LxW (mm)	CUT (mm)	H (mm)
21168	5W	350lm	70lm/W	35°	GU10	80	82x82	75x75	95





ÜRÜN ÖZELLİKLERİ/PRODUCT SPECIFICATIONS

Ürün Tanımı	Sıva Altı Spot	Product Description	Recessed Downlight
Gövde	Alüminyum Enjeksiyon	Body	Die-Cast Aluminum
Boya	Elektrostatik Toz Boya	Paint	Elektrostatic Powder Coated
PCB		PCB	
Lens		Lens	
Reflektör	Yüksek Safılıkta Alüminyum	Reflector	High Purity Aluminum
Difüzör		Diffuser	
SDCM (MacAdam)	3	SDCM (MacAdam)	3
Renk Sıcaklığı	2700K/3000K/4000K	Colour Temperature	2700K/3000K/4000K
Ömür	50000h	Life Time	50000h
Çalışma Sıcaklığı	25°C	Operating Temperature	25°C
LED	Osram/Tridonic/Nichia/Samsung/Cree	LED	Osram/Tridonic/Nichia/Samsung/Cree
Sürücü		Driver	
Uygunluk	EN 60598-1 EN 60598-2-2	Conformity	EN 60598-1 EN 60598-2-2

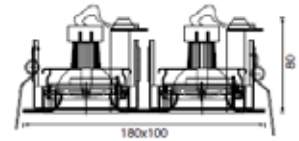

Ürün Kodu Product Code	Güç Power	Çıkış Işık Akısı Lumen Output	Verimlilik Efficiency	Işık Açısı Beam Angle	Işık Kaynağı Light Source	CRI	LxW (mm)	CUT (mm)	H (mm)
23039	2x5W	2x460Lm	92Lm/W	35°	GU10	80	180	100	80



Sıva Üstü

Spot



SOHO
Light Design

Surface Mounted

Spot



25007



25008

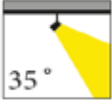

ÜRÜN ÖZELLİKLERİ/PRODUCT SPECIFICATIONS

Ürün Tanımı	Sıva Üstü Spot	Product Description	Surface Mounted Downlight
Gövde	Alüminyum	Body	Aluminum Housing
Boya	Elektrostatik Toz Boya	Paint	Elektrostatic Powder Coated
PCB		PCB	
Lens		Lens	
Reflektör	Siyah Renkli Alüminyum	Reflector	Aluminum in Black Colour
Difüzör		Diffuser	
SDCM (MacAdam)	3	SDCM (MacAdam)	3
Renk Sıcaklığı	2700K/3000K/4000K	Colour Temperature	2700K/3000K/4000K
Ömür	50000h	Life Time	50000h
Çalışma Sıcaklığı	25°C	Operating Temperature	25°C
LED		LED	
Uygunluk	EN 60598-1 EN 60598-2-2	Conformity	EN 60598-1 EN 60598-2-2

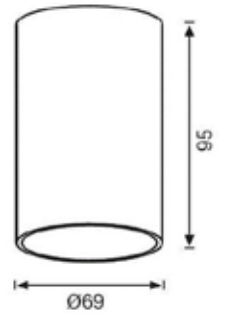

Ürün Kodu Product Code	Güç Power	Çıkış Işık Akısı Lumen Output	Verimlilik Efficiency	Işık Açısı Beam Angle	Işık Kaynağı Light Source	CRI	L (mm)	W (mm)	H (mm)
25007	5W	350Lm	70Lm/W	35°	GU10	80	69	68	95
25008	5W	350Lm	70Lm/W	35°	GU10	80	69	68	95



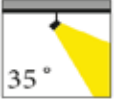

ÜRÜN ÖZELLİKLERİ/PRODUCT SPECIFICATIONS

Ürün Tanımı	Sıva Üstü Spot	Product Descripton	Surface Mounted
Gövde	Alüminyum Enjeksiyon	Body	Die-Cast Aluminum
Boya		Paint	
PCB		PCB	
Lens		Lens	
Reflektör	Yüksek Saflıkta Alüminyum	Reflector	High Purity Aluminum
Difüzör	Temperli Cam	Diffuser	Tempered Glass
SDCM (MacAdam)	3	SDCM (MacAdam)	3
Renk Sıcaklığı	2700K/3000K/4000K	Colour Temperature	2700K/3000K/4000K
Ömür	50000h	Life Time	50000h
Çalışma Sıcaklığı	25°C	Operating Temperature	25°C
LED	Osram/Samsung	LED	Osram/Samsung
Sürücü		Driver	
Uygunluk	EN 60598-1 EN 60598-2-2	Conformity	EN 60598-1 EN 60598-2-2

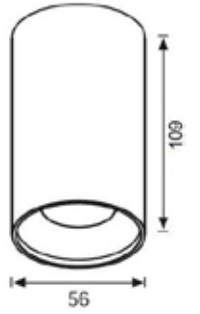

Ürün Kodu Product Code	Güç Power	Çıkış Işık Akısı Lumen Output	Verimlilik Efficiency	Işık Açısı Beam Angle	Işık Kaynağı Light Source	CRI	L (mm)	W (mm)	H (mm)
25077	5W	350Lm	70Lm/W	35°	GU10	80	56	56	109



SIVA ÜSTÜ SPOT / SURFACE MOUNTED DOWNLIGHT

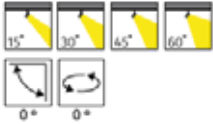

ÜRÜN ÖZELLİKLERİ/PRODUCT SPECIFICATIONS

Ürün Tanımı	Sıva Üstü Spot	Product Descripton	Surface Mounted
Gövde	Alüminyum Enjeksiyon	Body	Die-Cast Aluminum
Boya	Elektrostatik Toz Boya	Paint	Electrostatic Powder Coated
PCB		PCB	
Lens		Lens	
Reflektör	Yüksek Safılıkta Alüminyum	Reflector	High Purity Aluminum
Difüzör		Diffuser	
SDCM (MacAdam)	3	SDCM (MacAdam)	3
Renk Sıcaklığı	2700K/3000K/4000K/6500K	Colour Temperature	2700K/3000K/4000K/6500K
Ömür	50000h	Life Time	50000h
Çalışma Sıcaklığı	25°C	Operating Temperature	25°C
LED	Osram/Samsung	LED	Osram/Samsung
Sürücü		Driver	
Uygunluk	EN 60598-1 EN 60598-2-2	Conformity	EN 60598-1 EN 60598-2-2

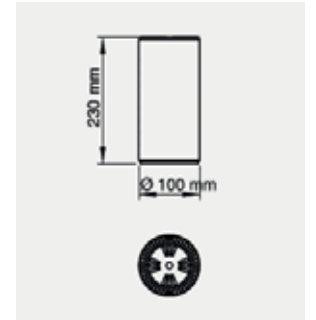

Ürün Kodu Product Code	Güç Power	Çıkış Işık Akısı Lumen Output	Verimlilik Efficiency	Işık Açısı Beam Angle	Işık Kaynağı Light Source	CRI	L (mm)	W (mm)	H (mm)
25122	20W	1774Lm	89Lm/W	15°/30°/45°/60°	LED	80	100	100	230
25123	30W	2938Lm	98Lm/W	15°/30°/45°/60°	LED	80	100	100	230



SIVA ÜSTÜ SPOT / SURFACE MOUNTED DOWNLIGHT

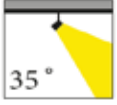

ÜRÜN ÖZELLİKLERİ/PRODUCT SPECIFICATIONS

Ürün Tanımı	Sıva Üstü Spot	Product Descripton	Surface Mounted
Gövde	Alüminyum Enjeksiyon	Body	Die-Cast Aluminum
Boya		Paint	
PCB		PCB	
Lens		Lens	
Reflektör	Yüksek Safılıkta Alüminyum	Reflector	High Purity Aluminum
Difüzör	Temperli Cam	Diffuser	Tempered Glass
SDCM (MacAdam)	3	SDCM (MacAdam)	3
Renk Sıcaklığı	2700K/3000K/4000K	Colour Temperature	2700K/3000K/4000K
Ömür	50000h	Life Time	50000h
Çalışma Sıcaklığı	25°C	Operating Temperature	25°C
LED	Osram/Samsung	LED	Osram/Samsung
Sürücü		Driver	
Uygunluk	EN 60598-1 EN 60598-2-2	Conformity	EN 60598-1 EN 60598-2-2



Ürün Kodu Product Code	Güç Power	Çıkış Işık Akısı Lumen Output	Verimlilik Efficiency	Işık Açısı Beam Angle	Işık Kaynağı Light Source	CRI	L (mm)	W (mm)	H (mm)
25032	5W	350lm	70Lm/W	35°	GU10	80	60	60	127





ÜRÜN ÖZELLİKLERİ/PRODUCT SPECIFICATIONS

Ürün Tanımı	Siva Üstü Spot	Product Description	Surface Mounted Downlight
Gövde	Metal Kaplama	Body	Metal Plating
Boya	Elektrostatik Toz Boya	Paint	Electrostatic Powder Coated
PCB		PCB	
Lens		Lens	
Reflektör	Yüksek Safılıkta Alüminyum	Reflector	High Purity Aluminum
Difüzör		Diffuser	
SDCM (MacAdam)	3	SDCM (MacAdam)	3
Renk Sıcaklığı	2700K/3000K/4000K	Colour Temperature	2700K/3000K/4000K
Ömür	50000h	Life Time	50000h
Çalışma Sıcaklığı	25°C	Operating Temperature	25°C
LED		LED	
Sürücü		Driver	
Uygunluk	EN 60598-1 EN 60598-2-2	Conformity	EN 60598-1 EN 60598-2-2

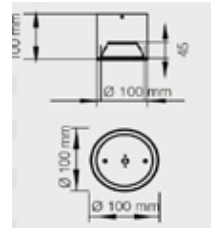

Ürün Kodu Product Code	Güç Power	Çıkış Işık Akısı Lumen Output	Verimlilik Efficiency	Işık Açısı Beam Angle	Işık Kaynağı Light Source	CRI	L (mm)	W (mm)	H (mm)
25080	5W	460Lm	92Lm/W	15°/30°/45°/60°	GU10	80	100	100	100
25081	8W	670Lm	83Lm/W	15°/30°/45°/60°	GU10	80	100	100	100



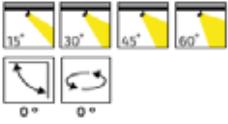

ÜRÜN ÖZELLİKLERİ/PRODUCT SPECIFICATIONS

Ürün Tanımı	Sıva Üstü Spot	Product Descripton	Surface Mounted
Gövde	Alüminyum Enjeksiyon	Body	Die-Cast Aluminum
Boya	Elektrostatik Toz Boya	Paint	Electrostatic Powder Coated
PCB		PCB	
Lens		Lens	
Reflektör	Yüksek Safılıkta Alüminyum	Reflector	High Purity Aluminum
Difüzör	Temperli Cam	Diffuser	Tempered Glass
SDCM (MacAdam)	3	SDCM (MacAdam)	3
Renk Sıcaklığı	2700K/3000K/4000K/6500K	Colour Temperature	2700K/3000K/4000K/6500K
Ömür	50000h	Life Time	50000h
Çalışma Sıcaklığı	25°C	Operating Temperature	25°C
LED	Osram/Samsung	LED	Osram/Samsung
Sürücü		Driver	
Uygunluk	EN 60598-1 EN 60598-2-2	Conformity	EN 60598-1 EN 60598-2-2

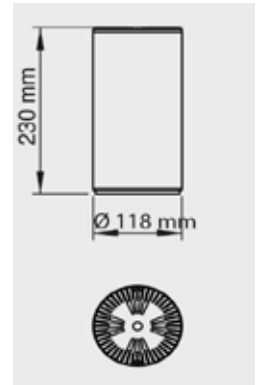

Ürün Kodu Product Code	Güç Power	Çıkış Işık Akısı Lumen Output	Verimlilik Efficiency	Işık Açısı Beam Angle	Işık Kaynağı Light Source	CRI	L (mm)	W (mm)	H (mm)
25015	30W	2938Lm	74Lm/W	15°/30°/45°/60°	LED	80	118	118	230
	35W	3256Lm	74Lm/W	15°/30°/45°/60°	LED	80	118	118	230



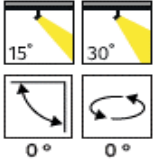

ÜRÜN ÖZELLİKLERİ/PRODUCT SPECIFICATIONS

Ürün Tanımı	Sıva Üstü Spot	Product Description	Surface Mounted Downlight
Gövde	Metal Kaplama	Body	Metal Plating
Boya	Elektrostatik Toz Boya	Paint	Elektrostatic Powder Coated
PCB		PCB	
Lens		Lens	
Reflektör	Yüksek Safılıkta Alüminyum	Reflector	High Purity Aluminum
Difüzör		Diffuser	
SDCM (MacAdam)	3	SDCM (MacAdam)	3
Renk Sıcaklığı	2700K/3000K/4000K	Colour Temperature	2700K/3000K/4000K
Ömür	50000h	Life Time	50000h
Çalışma Sıcaklığı	25°C	Operating Temperature	25°C
LED		LED	
Sürücü		Driver	
Uygunluk	EN 60598-1 EN 60598-2-2	Conformity	EN 60598-1 EN 60598-2-2

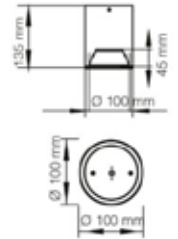

Ürün Kodu Product Code	Güç Power	Çıkış Işık Akısı Lumen Output	Verimlilik Efficiency	Işık Açısı Beam Angle	Işık Kaynağı Light Source	CRI	L (mm)	W (mm)	H (mm)
25086	5W	460Lm	92Lm/W	15°/30°	GU10	80	100	100	135
25087	8W	670Lm	83Lm/W	15°/30°	GU10	80	100	100	135
25088	8W	587Lm	73Lm/W	15°/30°	LED	80	100	100	135
25089	10W	654Lm	65Lm/W	15°/30°	LED	80	100	100	135



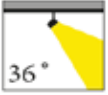
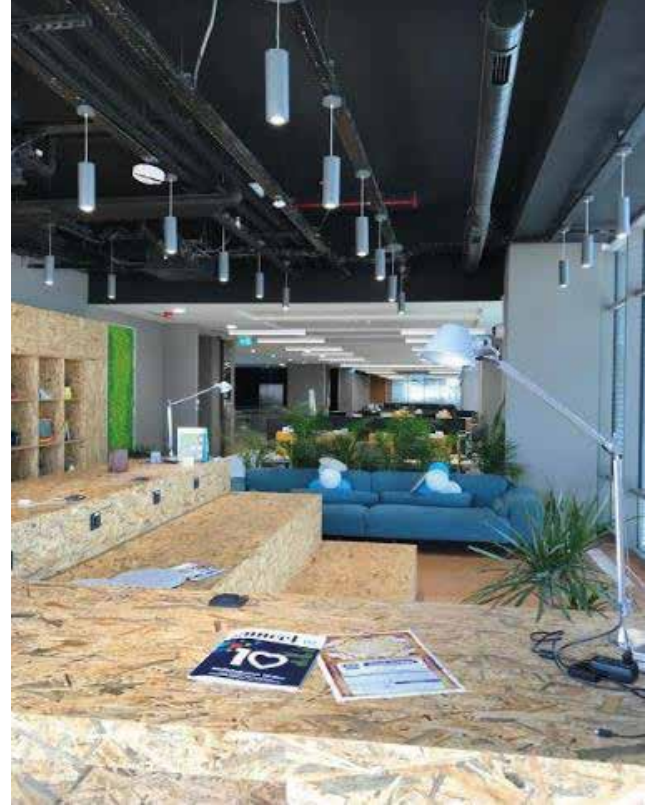

ÜRÜN ÖZELLİKLERİ/PRODUCT SPECIFICATIONS

Ürün Tanımı	Sarkit Armatür	Product Descripton	Suspension Luminaire
Gövde	Alüminyum Gövde	Body	Aluminum Housing
Boya		Paint	
PCB		PCB	
Lens		Lens	
Reflektör		Reflector	
Difüzör		Diffuser	
SDCM (MacAdam)	3	SDCM (MacAdam)	3
Renk Sıcaklığı	2700K/3000K/4000K	Colour Temperature	2700K/3000K/4000K
Ömür	15000h	Life Time	15000h
Çalışma Sıcaklığı	25°C	Operating Temperature	25°C
LED	Osram/Tridonic/Nichia/Samsung/ Cree	LED	Osram/Tridonic/Nichia/Samsung/ Cree
Sürücü		Driver	
Uygunluk	EN 60598-1 EN 60598-2-1	Conformity	EN 60598-1 EN 60598-2-1

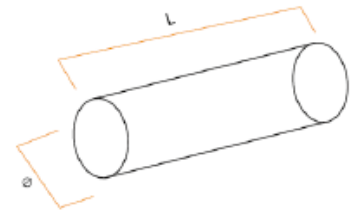

Ürün Kodu Product Code	Güç Power	Çıkış Işık Akısı Lumen Output	Verimlilik Efficiency	Işık Açısı Beam Angle	Işık Kaynağı Light Source	CRI	Ø (mm)	L (mm)
13036	5W	350Lm	70Lm/W	36°	GU10	80	85	300
13037	5W	350Lm	70Lm/W	36°	GU10	80	85	450
13038	5W	350Lm	70Lm/W	36°	GU10	80	85	600
13039	5W	350Lm	70Lm/W	36°	GU10	80	85	∞



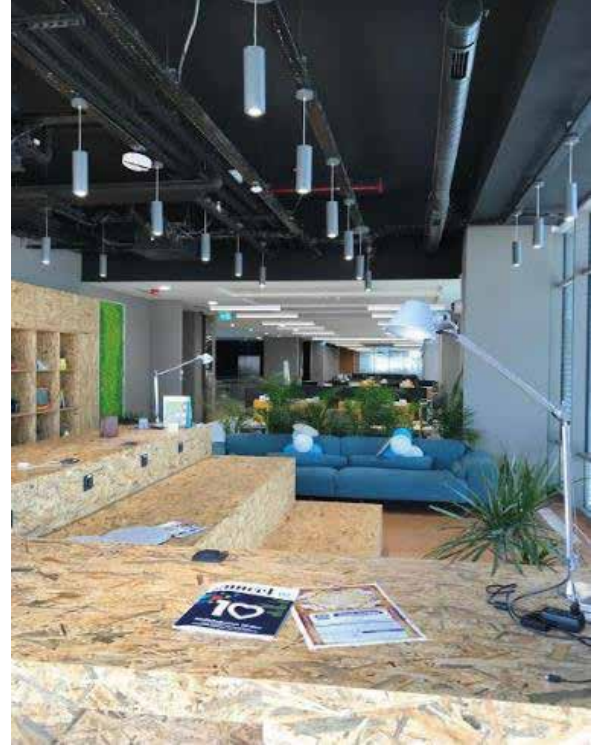

ÜRÜN ÖZELLİKLERİ/PRODUCT SPECIFICATIONS

Ürün Tanımı	Sarkit Armatür	Product Descripton	Suspension Luminaire
Gövde	Alüminyum Gövde	Body	Aluminum Housing
Boya		Paint	
PCB		PCB	
Lens		Lens	
Reflektör	Alüminyum	Reflector	Aluminum
Difüzör		Diffuser	
SDCM (MacAdam)	3	SDCM (MacAdam)	3
Renk Sıcaklığı	2700K/3000K/4000K	Colour Temperature	2700K/3000K/4000K
Ömür	50000h	Life Time	50000h
Çalışma Sıcaklığı	25°C	Operating Temperature	25°C
LED	Osram/Tridonic/Nichia/Samsung/Cree	LED	Osram/Tridonic/Nichia/Samsung/Cree
Sürücü		Driver	
Uygunluk	EN 60598-1 EN 60598-2-1	Conformity	EN 60598-1 EN 60598-2-1

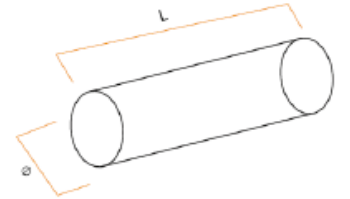
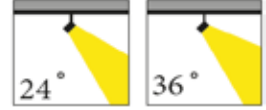

Ürün Kodu Product Code	Güç Power	Çıkış Işık Akısı Lumen Output	Verimlilik Efficiency	Işık Açısı Beam Angle	Işık Kaynağı Light Source	CRI	Ø (mm)	L (mm)
13040	8W	688Lm	86Lm/W	24°/36°	LED	80	85	300
13041	8W	688Lm	86Lm/W	24°/36°	LED	80	85	450
13042	8W	688Lm	86Lm/W	24°/36°	LED	80	85	600
13043	8W	688Lm	86Lm/W	24°/36°	LED	80	85	∞
13044	10W	860Lm	86Lm/W	24°/36°	LED	80	85	300
13045	10W	860Lm	86Lm/W	24°/36°	LED	80	85	450
13046	10W	860Lm	86Lm/W	24°/36°	LED	80	85	600
13047	10W	860Lm	86Lm/W	24°/36°	LED	80	85	∞
13048	15W	1290Lm	86Lm/W	24°/36°	LED	80	85	300
13049	15W	1290Lm	86Lm/W	24°/36°	LED	80	85	450
13050	15W	1290Lm	86Lm/W	24°/36°	LED	80	85	600
13051	15W	1290Lm	86Lm/W	24°/36°	LED	80	85	∞



SIVA ÜSTÜ SPOT / SURFACE MOUNTED DOWNLIGHT



ÜRÜN ÖZELLİKLERİ/PRODUCT SPECIFICATIONS

Ürün Tanımı	Siva Üstü Spot	Product Description	Surface Mounted
Gövde	Alüminyum Ekstrüzyon	Body	Aluminum Extrusion
Boya	Elektrostatik Toz Boya	Paint	Electrostatic Powder Coated
PCB		PCB	
Lens		Lens	
Reflektör		Reflector	
Difüzör	Polikarbon Cam	Diffuser	Polycarbonate Glass
SDCM (MacAdam)	3	SDCM (MacAdam)	3
Renk Sıcaklığı	2700K/6500K	Colour Temperature	2700K/6500K
Ömür	50000h	Life Time	50000h
Çalışma Sıcaklığı	25°C	Operating Temperature	25°C
LED	Samsung	LED	Samsung
Sürücü		Driver	
Uygunluk	EN 60598-1 EN 60598-2-2	Conformity	EN 60598-1 EN 60598-2-2

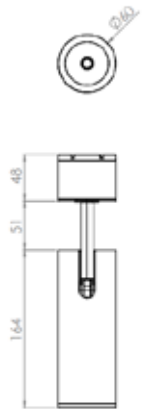

Ürün Kodu Product Code	Güç Power	Çıkış Işık Akısı Lumen Output	Verimlilik Efficiency	Işık Açısı Beam Angle	Işık Kaynağı Light Source	CRI	Ø (mm)	H (mm)
25110	9W	1120lm	124lm/W	24°/36°	LED	80	60	164
25111	14W	1820lm	124lm/W	24°/36°	LED	80	76	165
25112	20W	2480lm	124lm/W	24°/36°	LED	80	100	177





ÜRÜN ÖZELLİKLERİ/PRODUCT SPECIFICATIONS

Ürün Tanımı	Sıva Üstü Spot	Product Description	Surface Mounted
Gövde	Alüminyum Enjeksiyon	Body	Die-Cast Aluminum
Boya	Elektrostatik Toz Boya	Paint	Elektrostatic Powder Coated
PCB		PCB	
Lens		Lens	
Reflektör	Yüksek Safılıkta Alüminyum	Reflector	High Purity Aluminum
Difüzör	Temperli Cam	Diffuser	Tempered Glass
SDCM (MacAdam)	3	SDCM (MacAdam)	3
Renk Sıcaklığı	2700K/3000K/4000K	Colour Temperature	2700K/3000K/4000K
Ömür	50000h	Life Time	50000h
Çalışma Sıcaklığı	25°C	Operating Temperature	25°C
LED	Osram/Tridonic/Nichia/Samsung/Cree	LED	Osram/Tridonic/Nichia/Samsung/Cree
Sürücü		Driver	
Uygunluk	EN 60598-1 EN 60598-2-2	Conformity	EN 60598-1 EN 60598-2-2

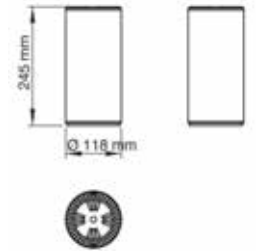

Ürün Kodu Product Code	Güç Power	Çıkış Işık Akısı Lumen Output	Verimlilik Efficiency	Işık Açısı Beam Angle	Işık Kaynağı Light Source	CRI	L (mm)	W (mm)	H (mm)
25016	15W	1455Lm	97Lm/W	15°/30°/45°	LED	80	118	118	245
25017	20W	1940Lm	97Lm/W	15°/30°/45°	LED	80	118	118	245
25018	25W	2425Lm	97Lm/W	15°/30°/45°	LED	80	118	118	245
25019	30W	2938Lm	97Lm/W	15°/30°/45°	LED	80	118	118	245
25020	35W	3256Lm	93Lm/W	15°/30°/45°	LED	80	118	118	245



SIVA ÜSTÜ SPOT / SURFACE MOUNTED DOWNLIGHT



ÜRÜN ÖZELLİKLERİ/PRODUCT SPECIFICATIONS

Ürün Tanımı	Sıva Üstü Spot	Product Description	Surface Mounted
Gövde	Alüminyum Enjeksiyon	Body	Die-Cast Aluminum
Boya	Elektrostatik Toz Boya	Paint	Electrostatic Powder Coated
PCB		PCB	
Lens		Lens	
Reflektör	Yüksek Safılıkta Alüminyum	Reflector	High Purity Aluminum
Difüzör	Temperli Cam	Diffuser	Tempered Glass
SDCM (MacAdam)	3	SDCM (MacAdam)	3
Renk Sıcaklığı	2700K/3000K/4000K	Colour Temperature	2700K/3000K/4000K
Ömür	50000h	Life Time	50000h
Çalışma Sıcaklığı	25°C	Operating Temperature	25°C
LED	Osram/Tridonic/Nichia/ Samsung/Cree	LED	Osram/Tridonic/Nichia/ Samsung/Cree
Sürücü		Driver	
Uygunluk	EN 60598-1 EN 60598-2-2	Conformity	EN 60598-1 EN 60598-2-2

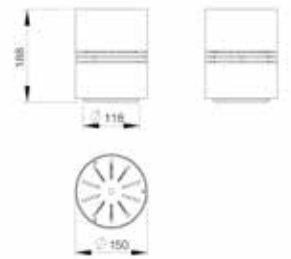

Ürün Kodu Product Code	Güç Power	Çıkış Işık Akısı Lumen Output	Verimlilik Efficiency	Işık Açısı Beam Angle	Işık Kaynağı Light Source	CRI	L (mm)	W (mm)	H (mm)
25021	15W	1455Lm	97Lm/W	15°/30°/45°/60°	LED	80	118	118	188
25022	20W	1940Lm	97Lm/W	15°/30°/45°/60°	LED	80	118	118	188
25023	25W	2425Lm	97Lm/W	15°/30°/45°/60°	LED	80	118	118	188
25024	30W	2938Lm	97Lm/W	15°/30°/45°/60°	LED	80	118	118	188
25025	35W	3256Lm	93Lm/W	15°/30°/45°/60°	LED	80	118	118	188
25026	40W	3537Lm	85Lm/W	15°/30°/45°/60°	LED	80	118	118	188



SIVA ÜSTÜ SPOT / SURFACE MOUNTED DOWNLIGHT



25009



25010

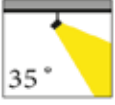

ÜRÜN ÖZELLİKLERİ/PRODUCT SPECIFICATIONS

Ürün Tanımı	Sıva Üstü Spot	Product Description	Surface Mounted Downlight
Gövde	Alüminyum	Body	Aluminum Housing
Boya	Elektrostatik Toz Boya	Paint	Elektrostatic Powder Coated
PCB		PCB	
Lens		Lens	
Reflektör	Siyah Renkli Alüminyum	Reflector	Aluminum in Black Colour
Difüzör		Diffuser	
SDCM (MacAdam)	3	SDCM (MacAdam)	3
Renk Sıcaklığı	2700K/3000K/4000K	Colour Temperature	2700K/3000K/4000K
Ömür	50000h	Life Time	50000h
Çalışma Sıcaklığı	25°C	Operating Temperature	25°C
LED		LED	
Uygunluk	EN 60598-1 EN 60598-2-2	Conformity	EN 60598-1 EN 60598-2-2

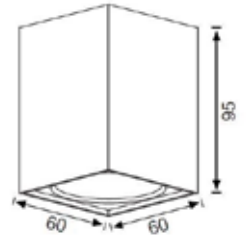

Ürün Kodu Product Code	Güç Power	Çıkış Işık Akısı Lumen Output	Verimlilik Efficiency	Işık Açısı Beam Angle	Işık Kaynağı Light Source	CRI	L (mm)	W (mm)	H (mm)
25009	5W	350Lm	70Lm/W	35°	GU10	80	60	60	100
25010	5W	350Lm	70Lm/W	35°	GU10	80	60	60	100



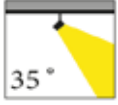

ÜRÜN ÖZELLİKLERİ/PRODUCT SPECIFICATIONS

Ürün Tanımı	Sıva Üstü Spot	Product Description	Surface Mounted Downlight
Gövde	Alüminyum	Body	Aluminum Housing
Boya	Elektrostatik Toz Boya	Paint	Elektrostatic Powder Coated
PCB		PCB	
Lens		Lens	
Reflektör	Altın Renkli Alüminyum	Reflector	Aluminum in Gold Colour
Difüzör		Diffuser	
SDCM (MacAdam)	3	SDCM (MacAdam)	3
Renk Sıcaklığı	2700K/3000K/4000K	Colour Temperature	2700K/3000K/4000K
Ömür	50000h	Life Time	50000h
Çalışma Sıcaklığı	25°C	Operating Temperature	25°C
LED		LED	
Sürücü		Driver	
Uygunluk	EN 60598-1 EN 60598-2-2	Conformity	EN 60598-1 EN 60598-2-2



Ürün Kodu Product Code	Güç Power	Çıkış Işık Akısı Lumen Output	Verimlilik Efficiency	Işık Açısı Beam Angle	Işık Kaynağı Light Source	CRI	L (mm)	W (mm)	H (mm)
25005-1	5W	350Lm	70Lm/W	35°	GU10	80	97	97	102
25005-2	5W	350Lm	70Lm/W	35°	GU10	80	97	97	102





ÜRÜN ÖZELLİKLERİ/PRODUCT SPECIFICATIONS

Ürün Tanımı	Siva Üstü Spot	Product Description	Surface Mounted Downlight
Gövde	Alüminyum Gövde	Body	Aluminum Head
Boya	Elektrostatik Toz Boya	Paint	Electrostatic Powder Coated
PCB		PCB	
Lens		Lens	
Reflektör		Reflector	
Difüzör		Diffuser	
SDCM (MacAdam)	3	SDCM (MacAdam)	3
Renk Sıcaklığı	2700K/3000K/4000K	Colour Temperature	2700K/3000K/4000K
Ömür	50000h	Life Time	50000h
Çalışma Sıcaklığı	25°C	Operating Temperature	25°C
LED		LED	
Sürücü		Driver	
Uygunluk	EN 60598-1 EN 60598-2-2	Conformity	EN 60598-1 EN 60598-2-2

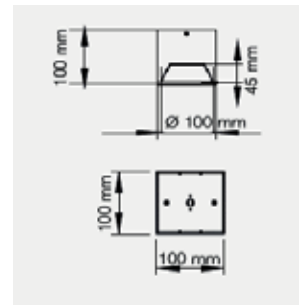

Ürün Kodu Product Code	Güç Power	Çıkış Işık Akısı Lumen Output	Verimlilik Efficiency	Işık Açısı Beam Angle	Işık Kaynağı Light Source	CRI	L (mm)	W (mm)	H (mm)
25078	5W	460Lm	92Lm/W	15°/30°	GU10	80	100	100	100
25079	8W	670Lm	83Lm/W	15°/30°	GU10	80	100	100	100



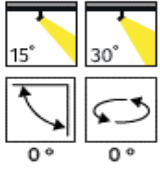

ÜRÜN ÖZELLİKLERİ/PRODUCT SPECIFICATIONS

Ürün Tanımı	Sıva Üstü Spot	Product Description	Surface Mounted Downlight
Gövde	Alüminyum Gövde	Body	Aluminum Head
Boya	Elektrostatik Toz Boya	Paint	Electrostatic Powder Coated
PCB		PCB	
Lens		Lens	
Reflektör	Yüksek Safılıkta Alüminyum	Reflector	High Purity Aluminum
Difüzör		Diffuser	
SDCM (MacAdam)	3	SDCM (MacAdam)	3
Renk Sıcaklığı	2700K/3000K/4000K	Colour Temperature	2700K/3000K/4000K
Ömür	50000h	Life Time	50000h
Çalışma Sıcaklığı	25°C	Operating Temperature	25°C
LED		LED	
Sürücü		Driver	
Uygunluk	EN 60598-1 EN 60598-2-2	Conformity	EN 60598-1 EN 60598-2-2

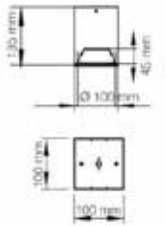

Ürün Kodu Product Code	Güç Power	Çıkış Işık Akısı Lumen Output	Verimlilik Efficiency	Işık Açısı Beam Angle	Işık Kaynağı Light Source	CRI	L (mm)	W (mm)	H (mm)
25082	5W	460Lm	92Lm/W	15°/30°	GU10	80	100	100	135
25083	8W	670Lm	83Lm/W	15°/30°	GU10	80	100	100	135
25084	8W	587Lm	73Lm/W	15°/30°	LED	80	100	100	135
25085	10W	654Lm	65Lm/W	15°/30°	LED	80	100	100	135



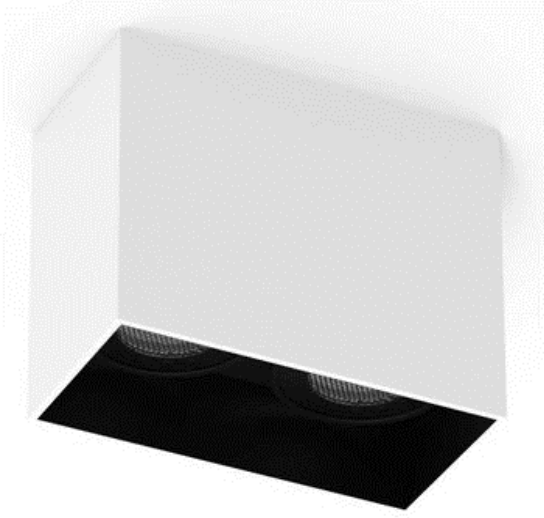

26002

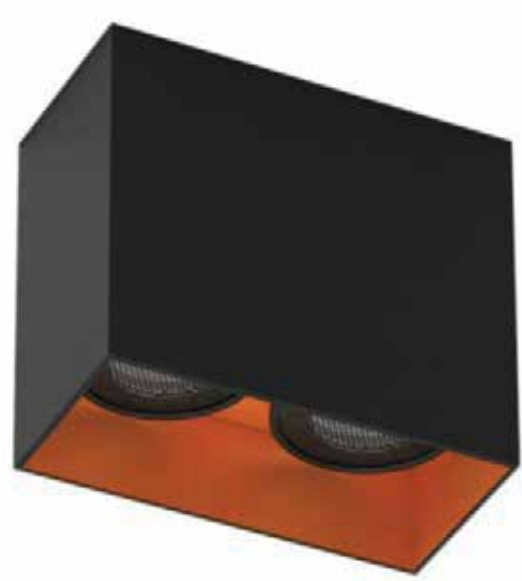

26003



ÜRÜN ÖZELLİKLERİ/PRODUCT SPECIFICATIONS

Ürün Tanımı	Sıva Üstü Spot	Product Description	Surface Mounted Downlight
Gövde	Alüminyum	Body	Aluminum Housing
Boya	Elektrostatik Toz Boya	Paint	Electrostatic Powder Coated
PCB		PCB	
Lens		Lens	
Reflektör		Reflector	
Difüzör		Diffuser	
SDCM (MacAdam)	3	SDCM (MacAdam)	3
Renk Sıcaklığı	2700K/3000K/4000K	Colour Temperature	2700K/3000K/4000K
Ömür	50000h	Life Time	50000h
Çalışma Sıcaklığı	25°C	Operating Temperature	25°C
LED		LED	
Uygunluk	EN 60598-1 EN 60598-2-2	Conformity	EN 60598-1 EN 60598-2-2

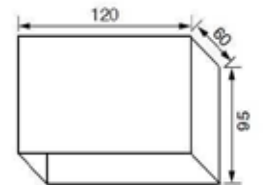

Ürün Kodu Product Code	Güç Power	Çıkış Işık Akısı Lumen Output	Verimlilik Efficiency	Işık Açısı Beam Angle	Işık Kaynağı Light Source	CRI	L (mm)	W (mm)	H (mm)
26002	2x5W	2x350Lm	70Lm/W	35°	GU10	80	120	60	95
26003	2x5W	2x350Lm	70Lm/W	35°	GU10	80	120	60	95



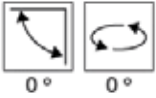

ÜRÜN ÖZELLİKLERİ/PRODUCT SPECIFICATIONS

Ürün Tanımı	Siva Üstü Spot	Product Description	Surface Mounted
Gövde	Alüminyum Enjeksiyon	Body	Die-Cast Aluminum
Boya	Elektrostatik Toz Boya	Paint	Elektrostatic Powder Coated
PCB		PCB	
Lens		Lens	
Reflektör	Parlak bitişli ve kamaşma önleyici, simetrik ışık çıkışı sağlayan dar, orta ve geniş açı seçeneekli	Reflector	High polished antiglare, narrow, medium and wide beam angle options available with rotationally symmetric light distribution
Difüzör		Diffuser	
SDCM (MacAdam)	3	SDCM (MacAdam)	3
Renk Sıcaklığı	2700K/3000K/4000K	Colour Temperature	2700K/3000K/4000K
Ömür	50000h	Life Time	50000h
Çalışma Sıcaklığı	25°C	Operating Temperature	25°C
LED	Samsung	LED	Samsung
Sürücü		Driver	
Uygunluk	EN 60598-1 EN 60598-2-2	Conformity	EN 60598-1 EN 60598-2-2

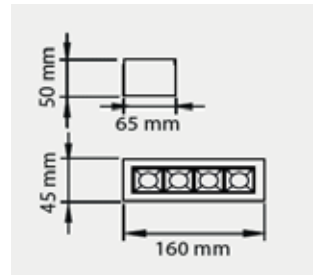

Ürün Kodu Product Code	Güç Power	Çıkış Işık Akısı Lumen Output	Verimlilik Efficiency	Işık Açısı Beam Angle	Işık Kaynağı Light Source	CRI	L (mm)	W (mm)	H (mm)
25119	5,93W	1040Lm	175Lm/W		LED	80	160	45	50



SIVA ÜSTÜ SPOT / SURFACE MOUNTED DOWNLIGHT

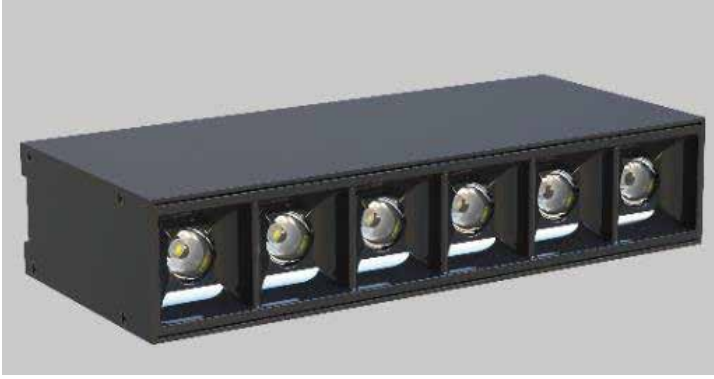

ÜRÜN ÖZELLİKLERİ/PRODUCT SPECIFICATIONS

Ürün Tanımı	Sıva Üstü Spot	Product Description	Surface Mounted
Gövde	Alüminyum Enjeksiyon	Body	Die-Cast Aluminum
Boya	Elektrostatik Toz Boya	Paint	Electrostatic Powder Coated
PCB		PCB	
Lens		Lens	
Reflektör		Reflector	
Difüzör		Diffuser	
SDCM (MacAdam)	3	SDCM (MacAdam)	3
Renk Sıcaklığı	2700K/3000K/4000K	Colour Temperature	2700K/3000K/4000K
Ömür	50000h	Life Time	50000h
Çalışma Sıcaklığı	25°C	Operating Temperature	25°C
LED	Samsung	LED	Samsung
Sürücü		Driver	
Uygunluk	EN 60598-1 EN 60598-2-2	Conformity	EN 60598-1 EN 60598-2-2

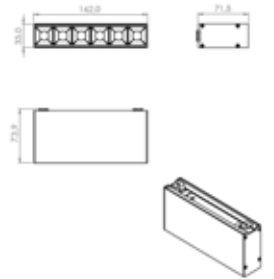

Ürün Kodu Product Code	Güç Power	Çıkış Işık Akısı Lumen Output	Verimlilik Efficiency	Işık Açısı Beam Angle	Işık Kaynağı Light Source	CRI	L (mm)	W (mm)	H (mm)
43011	10W	1100lm	110lm/W	15°/36°/48°/60°	LED	80	162	33	73,9
43013	20W	2200lm	110lm/W	15°/36°/48°/60°	LED	80	324	33	73,9



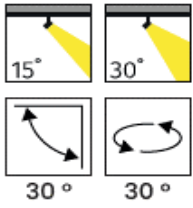

ÜRÜN ÖZELLİKLERİ/PRODUCT SPECIFICATIONS

Ürün Tanımı	Sıva Üstü Spot	Product Description	Surface Mounted
Gövde	Alüminyum Enjeksiyon	Body	Die-Cast Aluminum
Boya	Elektrostatik Toz Boya	Paint	Electrostatic Powder Coated
PCB		PCB	
Lens		Lens	
Reflektör	Yüksek Safılıkta Alüminyum	Reflector	High Purity Aluminum
Difüzör		Diffuser	
SDCM (MacAdam)	3	SDCM (MacAdam)	3
Renk Sıcaklığı	2700K/3000K/4000K	Colour Temperature	2700K/3000K/4000K
Ömür	50000h	Life Time	50000h
Çalışma Sıcaklığı	25°C	Operating Temperature	25°C
LED	Osram/Tridonic/Nichia/Samsung/Cree	LED	Osram/Tridonic/Nichia/Samsung/Cree
Sürücü		Driver	
Uygunluk	EN 60598-1 EN 60598-2-1	Conformity	EN 60598-1 EN 60598-2-1

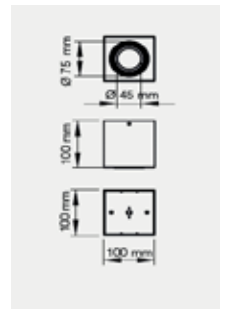

Ürün Kodu Product Code	Güç Power	Çıkış Işık Akısı Lumen Output	Verimlilik Efficiency	Işık Açısı Beam Angle	Işık Kaynağı Light Source	CRI	L (mm)	W (mm)	H (mm)
25002	10W	1000Lm	100Lm/W	15°/30°	LED	80	100	100	100
25042	5W	350Lm	70Lm/W	35°	GU10	80	100	100	100



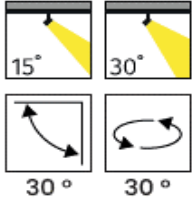

ÜRÜN ÖZELLİKLERİ/PRODUCT SPECIFICATIONS

Ürün Tanımı	Sıva Üstü Spot	Product Description	Surface Mounted
Gövde	Alüminyum Enjeksiyon	Body	Die-Cast Aluminum
Boya	Elektrostatik Toz Boya	Paint	Electrostatic Powder Coated
PCB		PCB	
Lens		Lens	
Reflektör	Yüksek Safılıkta Alüminyum	Reflector	High Purity Aluminum
Difüzör		Diffuser	
SDCM (MacAdam)	3	SDCM (MacAdam)	3
Renk Sıcaklığı	2700K/3000K/4000K	Colour Temperature	2700K/3000K/4000K
Ömür	50000h	Life Time	50000h
Çalışma Sıcaklığı	25°C	Operating Temperature	25°C
LED	Osram/Tridonic/Nichia/Samsung/Cree	LED	Osram/Tridonic/Nichia/Samsung/Cree
Sürücü		Driver	
Uygunluk	EN 60598-1 EN 60598-2-1	Conformity	EN 60598-1 EN 60598-2-1

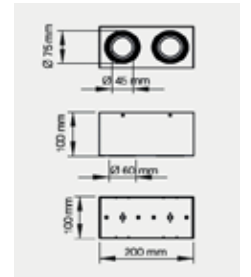

Ürün Kodu Product Code	Güç Power	Çıkış Işık Akısı Lumen Output	Verimlilik Efficiency	Işık Açısı Beam Angle	Işık Kaynağı Light Source	CRI	L (mm)	W (mm)	H (mm)
26009	2x8W	2x654Lm	81Lm/W	15°/30°	LED	80	200	100	100
26001	2x5W	2x350Lm	70Lm/W	35°	GU10	80	200	100	100



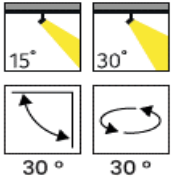

ÜRÜN ÖZELLİKLERİ/PRODUCT SPECIFICATIONS

Ürün Tanımı	Sıva Üstü Spot	Product Description	Surface Mounted
Gövde	Alüminyum Enjeksiyon	Body	Die-Cast Aluminum
Boya	Elektrostatik Toz Boya	Paint	Electrostatic Powder Coated
PCB		PCB	
Lens		Lens	
Reflektör	Yüksek Safılıkta Alüminyum	Reflector	High Purity Aluminum
Difüzör	Temperli Cam	Diffuser	Tempered Glass
SDCM (MacAdam)	3	SDCM (MacAdam)	3
Renk Sıcaklığı	2700K/3000K/4000K	Colour Temperature	2700K/3000K/4000K
Ömür	50000h	Life Time	50000h
Çalışma Sıcaklığı	25°C	Operating Temperature	25°C
LED	Osram/Tridonic/Nichia/Samsung/Cree	LED	Osram/Tridonic/Nichia/Samsung/Cree
Sürücü		Driver	
Uygunluk	EN 60598-1 EN 60598-2-2	Conformity	EN 60598-1 EN 60598-2-2

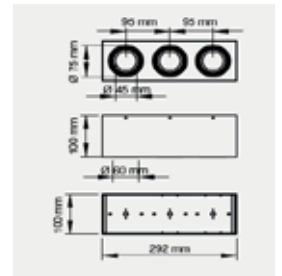

Ürün Kodu Product Code	Güç Power	Çıkış Işık Akısı Lumen Output	Verimlilik Efficiency	Işık Açısı Beam Angle	Işık Kaynağı Light Source	CRI	L (mm)	W (mm)	H (mm)
27006	3x8W	3x654Lm	81Lm/W	15°/30°	LED	80	292	100	100
27007	3x5W	3x350Lm	70Lm/W	35°	GU10	80	292	100	100



SIVA ÜSTÜ SPOT / SURFACE MOUNTED DOWNLIGHT

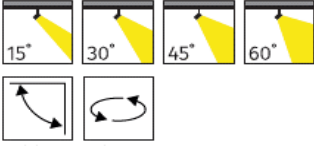

ÜRÜN ÖZELLİKLERİ/PRODUCT SPECIFICATIONS

Ürün Tanımı	Sıva Üstü Spot	Product Description	Surface Mounted
Gövde	Alüminyum Enjeksiyon	Body	Die-Cast Aluminum
Boya	Elektrostatik Toz Boya	Paint	Electrostatic Powder Coated
PCB		PCB	
Lens		Lens	
Reflektör	Yüksek Safılıkta Alüminyum	Reflector	High Purity Aluminum
Difüzör	Temperli Cam	Diffuser	Tempered Glass
SDCM (MacAdam)	3	SDCM (MacAdam)	3
Renk Sıcaklığı	2700K/3000K/4000K	Colour Temperature	2700K/3000K/4000K
Ömür	50000h	Life Time	50000h
Çalışma Sıcaklığı	25°C	Operating Temperature	25°C
LED	Osram/Tridonic/Nichia/ Samsung/Cree	LED	Osram/Tridonic/Nichia/ Samsung/Cree
Sürücü		Driver	
Uygunluk	EN 60598-1 EN 60598-2-2	Conformity	EN 60598-1 EN 60598-2-2

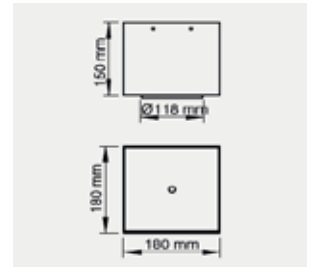

Ürün Kodu Product Code	Güç Power	Çıkış Işık Akısı Lumen Output	Verimlilik Efficiency	Işık Açısı Beam Angle	Işık Kaynağı Light Source	CRI	L (mm)	W (mm)	H (mm)
25027	15W	1455Lm	97Lm/W	15°/30°/45°/60°	LED	80	180	180	150
25028	20W	1940Lm	97Lm/W	15°/30°/45°/60°	LED	80	180	180	150
25029	25W	2425Lm	97Lm/W	15°/30°/45°/60°	LED	80	180	180	150
25030	30W	2938Lm	97Lm/W	15°/30°/45°/60°	LED	80	180	180	150
25031	35W	3256Lm	93Lm/W	15°/30°/45°/60°	LED	80	180	180	150





ÜRÜN ÖZELLİKLERİ/PRODUCT SPECIFICATIONS

Ürün Tanımı	Sıva Üstü Spot	Product Description	Surface Mounted
Gövde	Alüminyum Enjeksiyon	Body	Die-Cast Aluminum
Boya	Elektrostatik Toz Boya	Paint	Elektrostatic Powder Coated
PCB		PCB	
Lens		Lens	
Reflektör	Yüksek Safılıkta Alüminyum	Reflector	High Purity Aluminum
Difüzör	Temperli Cam	Diffuser	Tempered Glass
SDCM (MacAdam)	3	SDCM (MacAdam)	3
Renk Sıcaklığı	2700K/3000K/4000K	Colour Temperature	2700K/3000K/4000K
Ömür	50000h	Life Time	50000h
Çalışma Sıcaklığı	25°C	Operating Temperature	25°C
LED	Osram/Tridonic/Nichia/Samsung/Cree	LED	Osram/Tridonic/Nichia/Samsung/Cree
Sürücü		Driver	
Uygunluk	EN 60598-1 EN 60598-2-2	Conformity	EN 60598-1 EN 60598-2-2

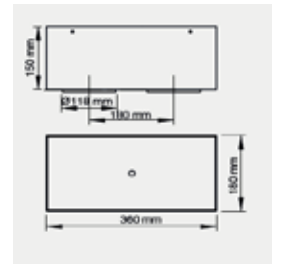

Ürün Kodu Product Code	Güç Power	Çıkış Işık Akısı Lumen Output	Verimlilik Efficiency	Işık Açısı Beam Angle	Işık Kaynağı Light Source	CRI	L (mm)	W (mm)	H (mm)
26004	2x15W	2x1455Lm	97Lm/W	15°/30°/45°/60°	LED	80	360	180	150
26005	2x20W	2x1940Lm	97Lm/W	15°/30°/45°/60°	LED	80	360	180	150
26006	2x25W	2x2425Lm	97Lm/W	15°/30°/45°/60°	LED	80	360	180	150
26007	2x30W	2x2938Lm	97Lm/W	15°/30°/45°/60°	LED	80	360	180	150
26008	2x35W	2x3256Lm	93Lm/W	15°/30°/45°/60°	LED	80	360	180	150



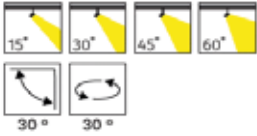
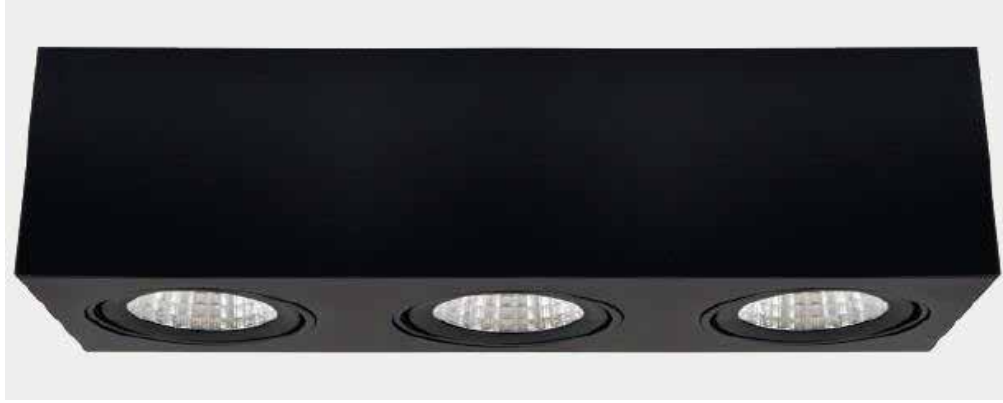

ÜRÜN ÖZELLİKLERİ/PRODUCT SPECIFICATIONS

Ürün Tanımı	Sıva Üstü Spot	Product Description	Surface Mounted
Gövde	Alüminyum Enjeksiyon	Body	Die-Cast Aluminum
Boya	Elektrostatik Toz Boya	Paint	Elektrostatic Powder Coated
PCB		PCB	
Lens		Lens	
Reflektör	Yüksek Safılıkta Alüminyum	Reflector	High Purity Aluminum
Difüzör	Temperli Cam	Diffuser	Tempered Glass
SDCM (MacAdam)	3	SDCM (MacAdam)	3
Renk Sıcaklığı	2700K/3000K/4000K	Colour Temperature	2700K/3000K/4000K
Ömür	50000h	Life Time	50000h
Çalışma Sıcaklığı	25°C	Operating Temperature	25°C
LED	Osram/Tridonic/Nichia/Samsung/Cree	LED	Osram/Tridonic/Nichia/Samsung/Cree
Sürücü		Driver	
Uygunluk	EN 60598-1 EN 60598-2-2	Conformity	EN 60598-1 EN 60598-2-2

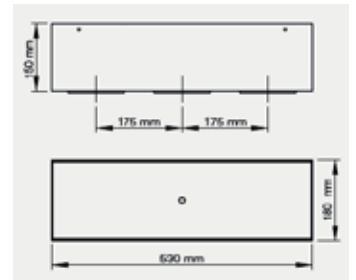

Ürün Kodu Product Code	Güç Power	Çıkış Işık Akısı Lumen Output	Verimlilik Efficiency	Işık Açısı Beam Angle	Işık Kaynağı Light Source	CRI	L (mm)	W (mm)	H (mm)
27001	3x15W	3x1455Lm	97Lm/W	15°/30°/45°/60°	LED	80	530	180	150
27002	3x20W	3x1940Lm	97Lm/W	15°/30°/45°/60°	LED	80	530	180	150
27003	3x25W	3x2425Lm	97Lm/W	15°/30°/45°/60°	LED	80	530	180	150
27004	3x30W	3x2938Lm	97Lm/W	15°/30°/45°/60°	LED	80	530	180	150
27005	3x35W	3x3256Lm	93Lm/W	15°/30°/45°/60°	LED	80	530	180	150



Downlights



Downlights

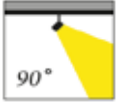
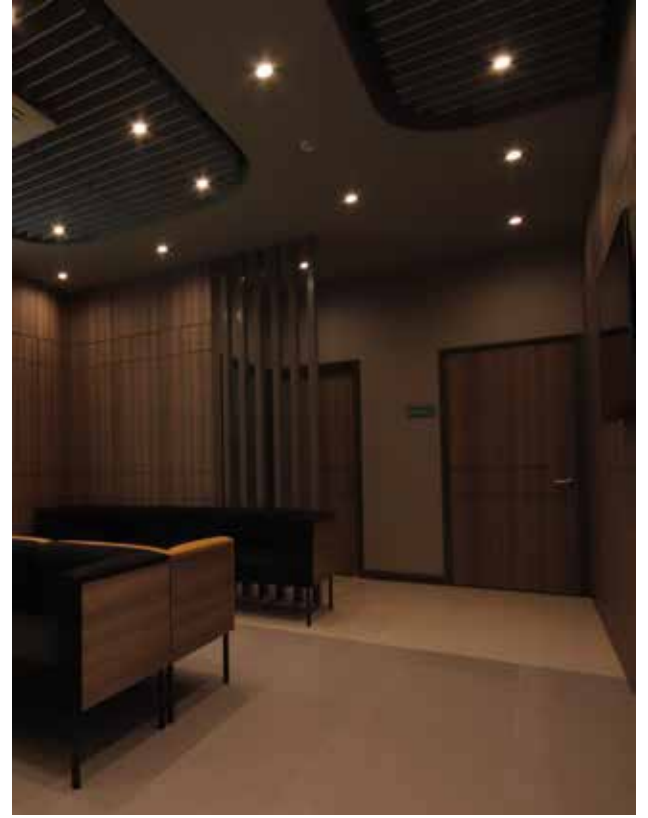
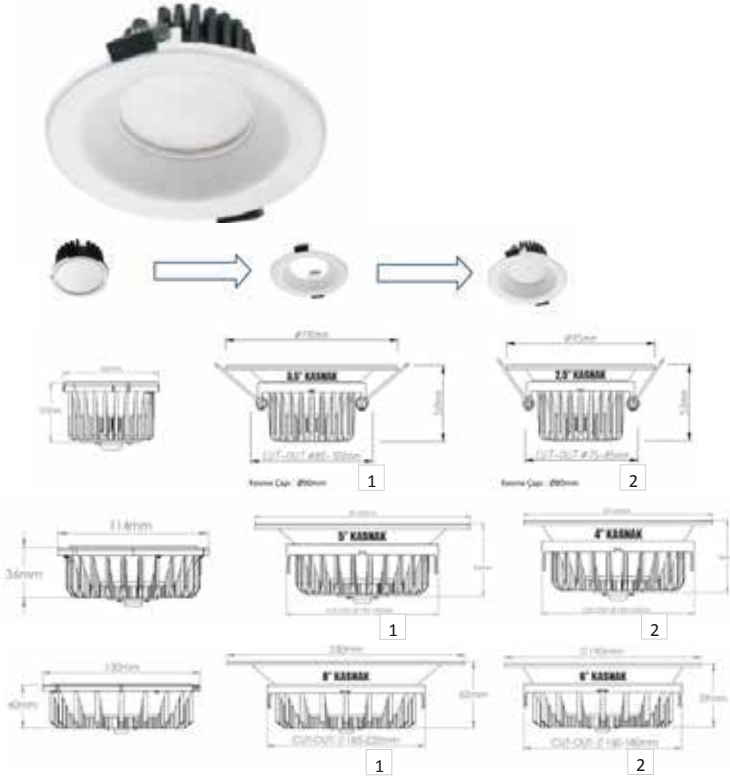

ÜRÜN ÖZELLİKLERİ/PRODUCT SPECIFICATIONS

Ürün Tanımı	Sıva Altı Downlight	Product Description	Recessed Downlight
Gövde	Alüminyum Enjeksiyon	Body	Die-Cast Aluminum
Boya		Paint	
PCB		PCB	
Lens		Lens	
Reflektör		Reflector	
Difüzör	Opal	Diffuser	Opal
SDCM (MacAdam)	3	SDCM (MacAdam)	3
Renk Sıcaklığı	2700K/3000K/4000K/6500K	Colour Temperature	2700K/3000K/4000K/6500K
Ömür	50000h	Life Time	50000h
Çalışma Sıcaklığı	25°C	Operating Temperature	25°C
LED	Osram	LED	Osram
Sürücü	Tridonic	Driver	Tridonic
Uygunluk	EN 60598-1 EN 60598-2-2	Conformity	EN 60598-1 EN 60598-2-2

Ürün Kodu Product Code	Güç Power	Çıkış Işık Akısı Lumen Output	Verimlilik Efficiency	Işık Açısı Beam Angle	Işık Kaynağı Light Source	CRI	Ø (mm)	CUT (mm)	H (mm)
17009-1	5W	450Lm	90Lm/W	90°	LED	80	110	80-100	50
17009-2	5W	450Lm	90Lm/W	90°	LED	80	95	75-85	50
17005-1	10W	925Lm	92,5Lm/W	90°	LED	80	110	80-100	50
17005-2	10W	925Lm	92,5Lm/W	90°	LED	80	95	75-85	50
17011-1	12W	1189Lm	99Lm/W	90°	LED	80	165	130-150	54
17011-2	12W	1189Lm	99Lm/W	90°	LED	80	145	125-135	54
17001-1	15W	1430Lm	95Lm/W	90°	LED	80	165	130-150	54
17001-2	15W	1430Lm	95Lm/W	90°	LED	80	145	125-135	54
17012-1	20W	2050Lm	102,5Lm/W	90°	LED	80	230	185-220	62
17012-2	20W	2050Lm	102,5Lm/W	90°	LED	80	190	160-180	59
17013-1	30W	2960Lm	99Lm/W	90°	LED	80	230	185-220	62
17013-2	30W	2960Lm	99Lm/W	90°	LED	80	190	160-180	59



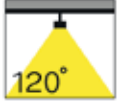

ÜRÜN ÖZELLİKLERİ/PRODUCT SPECIFICATIONS

Ürün Tanımı	Downlight Armatür	Product Descripton	Downlight Luminaire
Gövde	Alüminyum Enjeksiyon	Body	Die-Cast Aluminum
Boya		Paint	
PCB	Isı İletkenliği Yüksek PCB	PCB	High Conductive Heat -Resistance PCB
Lens		Lens	
Reflektör		Reflector	
Difüzör	Opal	Diffuser	Opal
SDCM (MacAdam)	3	SDCM (MacAdam)	3
Renk Sıcaklığı	2700K-6500K	Colour Temperature	2700K-6500K
Ömür	50000h	Life Time	50000h
Çalışma Sıcaklığı	0°C- +40°C	Operating Temperature	0°C- +40°C
LED	Osram/Philips/Cree	LED	Osram/Philips/Cree
Sürücü	Tridonic/Eaglerise	Driver	Tridonic/Eaglerise
Uygunluk	EN 60598-2-2	Conformity	EN 60598-2-2

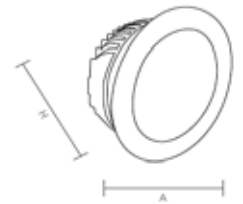

Ürün Kodu Product Code	Güç Power	Çıkış Işık Akısı Lumen Output	Verimlilik Efficiency	Işık Açısı Beam Angle	Işık Kaynağı Light Source	CRI	A (mm)	Ø CUT (mm)	H (mm)
17063	8W	800Lm	100Lm/W	120°	LED	80	108	90	65
17064	10W	1000Lm	100Lm/W	120°	LED	80	128	105	55
17065	15W	1500Lm	100Lm/W	120°	LED	80	150	130	55
17066	18W	1800Lm	100Lm/W	120°	LED	80	180	160	55
17067	25W	2500Lm	100Lm/W	120°	LED	80	200	180	55
17068	30W	3000Lm	100Lm/W	120°	LED	80	240	210	55





ÜRÜN ÖZELLİKLERİ/PRODUCT SPECIFICATIONS

Ürün Tanımı	Downlight Armatür	Product Descripton	Downlight Luminaire
Gövde	Alüminyum Enjeksiyon	Body	Die-Cast Aluminum
Boya		Paint	
PCB	Isı İletkenliği Yüksek PCB	PCB	High Conductive Heat -Resistance PCB
Lens		Lens	
Reflektör		Reflector	
Difüzör	Opal	Diffuser	Opal
SDCM (MacAdam)	3	SDCM (MacAdam)	3
Renk Sıcaklığı	2700K-6500K	Colour Temperature	2700K-6500K
Ömür	50000h	Life Time	50000h
Çalışma Sıcaklığı	0°C- +40°C	Operating Temperature	0°C- +40°C
LED	Osram/Philips/Cree	LED	Osram/Philips/Cree
Sürücü	Tridonic/Eaglerise	Driver	Tridonic/Eaglerise
Uygunluk	EN 60598-2-2	Conformity	EN 60598-2-2

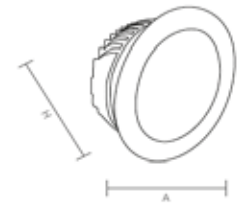

Ürün Kodu Product Code	Güç Power	Çıkış Işık Akısı Lumen Output	Verimlilik Efficiency	Işık Açısı Beam Angle	Işık Kaynağı Light Source	CRI	A (mm)	Ø CUT (mm)	H (mm)
17069	8W	800Lm	100Lm/W	120°	LED	80	97	85	55
17070	10W	1000Lm	100Lm/W	120°	LED	80	117	105	48
17071	15W	1500Lm	100Lm/W	120°	LED	80	147	130	54
17072	18W	1800Lm	100Lm/W	120°	LED	80	175	160	58
17073	25W	2500Lm	100Lm/W	120°	LED	80	192	175	55
17074	30W	3000Lm	100Lm/W	120°	LED	80	227	210	58



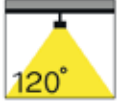

ÜRÜN ÖZELLİKLERİ/PRODUCT SPECIFICATIONS

Ürün Tanımı	Downlight Armatür	Product Descripton	Downlight Luminaire
Gövde	Alüminyum Enjeksiyon	Body	Die-Cast Aluminum
Boya		Paint	
PCB	Isı İletkenliği Yüksek PCB	PCB	High Conductive Heat -Resistance PCB
Lens		Lens	
Reflektör		Reflector	
Difüzör	Opal	Diffuser	Opal
SDCM (MacAdam)	3	SDCM (MacAdam)	3
Renk Sıcaklığı	2700K-6500K	Colour Temperature	2700K-6500K
Ömür	50000h	Life Time	50000h
Çalışma Sıcaklığı	0°C- +40°C	Operating Temperature	0°C- +40°C
LED	Osram/Philips/Cree	LED	Osram/Philips/Cree
Sürücü	Tridonic/Eaglerise	Driver	Tridonic/Eaglerise
Uygunluk	EN 60598-2-2	Conformity	EN 60598-2-2

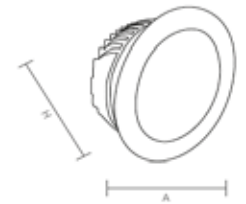

Ürün Kodu Product Code	Güç Power	Çıkış Işık Akısı Lumen Output	Verimlilik Efficiency	Işık Açısı Beam Angle	Işık Kaynağı Light Source	CRI	A (mm)	Ø CUT (mm)	H (mm)
17075	10W	1000Lm	100Lm/W	120°	LED	80	128	105	25
17076	15W	1500Lm	100Lm/W	120°	LED	80	150	130	25
17077	25W	2500Lm	100Lm/W	120°	LED	80	200	180	25
17078	30W	3000Lm	100Lm/W	120°	LED	80	240	210	25





ÜRÜN ÖZELLİKLERİ/PRODUCT SPECIFICATIONS

Ürün Tanımı	Downlight Armatür	Product Descripton	Downlight Luminaire
Gövde	Alüminyum Enjeksiyon	Body	Die-Cast Aluminum
Boya		Paint	
PCB	Isı İletkenliği Yüksek PCB	PCB	High Conductive Heat -Resistance PCB
Lens		Lens	
Reflektör		Reflector	
Difüzör	Opal	Diffuser	Opal
SDCM (MacAdam)	3	SDCM (MacAdam)	3
Renk Sıcaklığı	2700K-6500K	Colour Temperature	2700K-6500K
Ömür	50000h	Life Time	50000h
Çalışma Sıcaklığı	0°C- +40°C	Operating Temperature	0°C- +40°C
LED	Osram/Philips/Cree	LED	Osram/Philips/Cree
Sürücü	Tridonic/Eaglerise	Driver	Tridonic/Eaglerise
Uygunluk	EN 60598-2-2	Conformity	EN 60598-2-2

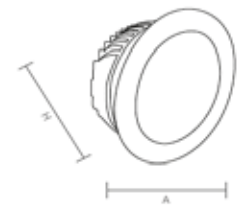

Ürün Kodu Product Code	Güç Power	Çıkış Işık Akısı Lumen Output	Verimlilik Efficiency	Işık Açısı Beam Angle	Işık Kaynağı Light Source	CRI	A (mm)	Ø CUT (mm)	H (mm)
17079	8W	800Lm	100Lm/W	120°	LED	80	97	85	70
17080	10W	1000Lm	100Lm/W	120°	LED	80	117	105	70
17081	12W	1200Lm	100Lm/W	120°	LED	80	147	130	75
17082	15W	1500Lm	100Lm/W	120°	LED	80	175	160	85
17083	20W	2000Lm	100Lm/W	120°	LED	80	192	175	85
17084	25W	2500Lm	100Lm/W	120°	LED	80	227	210	85





ÜRÜN ÖZELLİKLERİ/PRODUCT SPECIFICATIONS

Ürün Tanımı	Downlight Armatür	Product Descripton	Downlight Luminaire
Gövde	Alüminyum Enjeksiyon	Body	Die-Cast Aluminum
Boya		Paint	
PCB	Isı İletkenliği Yüksek PCB	PCB	High Conductive Heat -Resistance PCB
Lens		Lens	
Reflektör		Reflector	
Difüzör	Opal	Diffuser	Opal
SDCM (MacAdam)	3	SDCM (MacAdam)	3
Renk Sıcaklığı	2700K-6500K	Colour Temperature	2700K-6500K
Ömür	50000h	Life Time	50000h
Çalışma Sıcaklığı	0°C- +40°C	Operating Temperature	0°C- +40°C
LED	Osram/Philips/Cree	LED	Osram/Philips/Cree
Sürücü	Tridonic/Eaglerise	Driver	Tridonic/Eaglerise
Uygunluk	EN 60598-2-2	Conformity	EN 60598-2-2

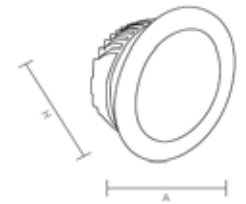

Ürün Kodu Product Code	Güç Power	Çıkış Işık Akısı Lumen Output	Verimlilik Efficiency	Işık Açısı Beam Angle	Işık Kaynağı Light Source	CRI	A (mm)	Ø CUT (mm)	H (mm)
17085	8W	800Lm	100Lm/W	120°	LED	80	97	85	70
17086	10W	1000Lm	100Lm/W	120°	LED	80	117	105	70
17087	12W	1200Lm	100Lm/W	120°	LED	80	147	130	75
17088	15W	1500Lm	100Lm/W	120°	LED	80	175	160	85
17089	20W	2000Lm	100Lm/W	120°	LED	80	192	175	85
17090	25W	2500Lm	100Lm/W	120°	LED	80	227	210	85





ÜRÜN ÖZELLİKLERİ/PRODUCT SPECIFICATIONS

Ürün Tanımı	Downlight Armatür	Product Descripton	Downlight Luminaire
Gövde	Alüminyum Enjeksiyon	Body	Die-Cast Aluminum
Boya		Paint	
PCB	Isı İletkenliği Yüksek PCB	PCB	High Conductive Heat -Resistance PCB
Lens		Lens	
Reflektör		Reflector	
Difüzör	Opal	Diffuser	Opal
SDCM (MacAdam)	3	SDCM (MacAdam)	3
Renk Sıcaklığı	2700K-6500K	Colour Temperature	2700K-6500K
Ömür	50000h	Life Time	50000h
Çalışma Sıcaklığı	0°C- +40°C	Operating Temperature	0°C- +40°C
LED	Osram/Philips/Cree	LED	Osram/Philips/Cree
Sürücü	Tridonic/Eaglerise	Driver	Tridonic/Eaglerise
Uygunluk	EN 60598-2-2	Conformity	EN 60598-2-2

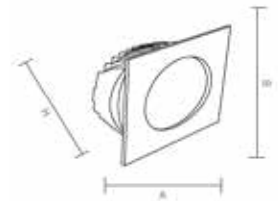

Ürün Kodu Product Code	Güç Power	Çıkış Işık Akısı Lumen Output	Verimlilik Efficiency	Işık Açısı Beam Angle	Işık Kaynağı Light Source	CRI	A/B (mm)	Ø CUT (mm)	H (mm)
17091	8W	800Lm	100Lm/W	120°	LED	80	108X108	90	65
17092	10W	1000Lm	100Lm/W	120°	LED	80	128X128	105	55
17093	15W	1500Lm	100Lm/W	120°	LED	80	150X150	130	55
17094	18W	1800Lm	100Lm/W	120°	LED	80	180X180	160	55
17095	25W	2500Lm	100Lm/W	120°	LED	80	200X200	180	55
17096	30W	3000Lm	100Lm/W	120°	LED	80	240X240	210	58





ÜRÜN ÖZELLİKLERİ/PRODUCT SPECIFICATIONS

Ürün Tanımı	Downlight Armatür	Product Descripton	Downlight Luminaire
Gövde	Alüminyum Enjeksiyon	Body	Die-Cast Aluminum
Boya		Paint	
PCB	Isı İletkenliği Yüksek PCB	PCB	High Conductive Heat -Resistance PCB
Lens		Lens	
Reflektör		Reflector	
Difüzör	Opal	Diffuser	Opal
SDCM (MacAdam)	3	SDCM (MacAdam)	3
Renk Sıcaklığı	2700K-6500K	Colour Temperature	2700K-6500K
Ömür	50000h	Life Time	50000h
Çalışma Sıcaklığı	0°C- +40°C	Operating Temperature	0°C- +40°C
LED	Osram/Philips/Cree	LED	Osram/Philips/Cree
Sürücü	Tridonic/Eaglerise	Driver	Tridonic/Eaglerise
Uygunluk	EN 60598-2-2	Conformity	EN 60598-2-2

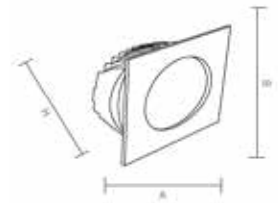

Ürün Kodu Product Code	Güç Power	Çıkış Işık Akısı Lumen Output	Verimlilik Efficiency	Işık Açısı Beam Angle	Işık Kaynağı Light Source	CRI	A/B (mm)	Ø CUT (mm)	H (mm)
17097	8W	800Lm	100Lm/W	120°	LED	80	97X97	85	55
17098	10W	1000Lm	100Lm/W	120°	LED	80	117X117	105	48
17099	15W	1500Lm	100Lm/W	120°	LED	80	147X147	130	54
17100	18W	1800Lm	100Lm/W	120°	LED	80	175X175	160	58
17101	25W	2500Lm	100Lm/W	120°	LED	80	195X195	180	55
17102	30W	3000Lm	100Lm/W	120°	LED	80	227X227	210	58



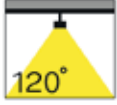

ÜRÜN ÖZELLİKLERİ/PRODUCT SPECIFICATIONS

Ürün Tanımı	Downlight Armatür	Product Descripton	Downlight Luminaire
Gövde	Alüminyum Enjeksiyon	Body	Die-Cast Aluminum
Boya		Paint	
PCB	Isı İletkenliği Yüksek PCB	PCB	High Conductive Heat -Resistance PCB
Lens		Lens	
Reflektör		Reflector	
Difüzör	Opal	Diffuser	Opal
SDCM (MacAdam)	3	SDCM (MacAdam)	3
Renk Sıcaklığı	2700K-6500K	Colour Temperature	2700K-6500K
Ömür	50000h	Life Time	50000h
Çalışma Sıcaklığı	0°C- +40°C	Operating Temperature	0°C- +40°C
LED	Osram/Philips/Cree	LED	Osram/Philips/Cree
Sürücü	Tridonic/Eaglerise	Driver	Tridonic/Eaglerise
Uygunluk	EN 60598-2-2	Conformity	EN 60598-2-2

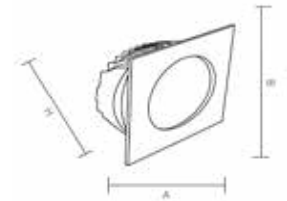

Ürün Kodu Product Code	Güç Power	Çıkış Işık Akısı Lumen Output	Verimlilik Efficiency	Işık Açısı Beam Angle	Işık Kaynağı Light Source	CRI	A/B (mm)	Ø CUT (mm)	H (mm)
17103	8W	800Lm	100Lm/W	120°	LED	80	97X97	85	70
17104	10W	1000Lm	100Lm/W	120°	LED	80	117X117	105	70
17105	12W	1200Lm	100Lm/W	120°	LED	80	147X147	130	75
17106	15W	1500Lm	100Lm/W	120°	LED	80	175X175	160	85
17107	20W	2000Lm	100Lm/W	120°	LED	80	195X195	180	85
17108	25W	2500Lm	100Lm/W	120°	LED	80	227X227	210	85



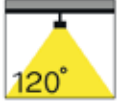

ÜRÜN ÖZELLİKLERİ/PRODUCT SPECIFICATIONS

Ürün Tanımı	Downlight Armatür	Product Descripton	Downlight Luminaire
Gövde	Alüminyum Enjeksiyon	Body	Die-Cast Aluminum
Boya		Paint	
PCB	Isı İletkenliği Yüksek PCB	PCB	High Conductive Heat -Resistance PCB
Lens		Lens	
Reflektör		Reflector	
Difüzör	Opal	Diffuser	Opal
SDCM (MacAdam)	3	SDCM (MacAdam)	3
Renk Sıcaklığı	2700K-6500K	Colour Temperature	2700K-6500K
Ömür	50000h	Life Time	50000h
Çalışma Sıcaklığı	0°C- +40°C	Operating Temperature	0°C- +40°C
LED	Osram/Philips/Cree	LED	Osram/Philips/Cree
Sürücü	Tridonic/Eaglerise	Driver	Tridonic/Eaglerise
Uygunluk	EN 60598-2-2	Conformity	EN 60598-2-2

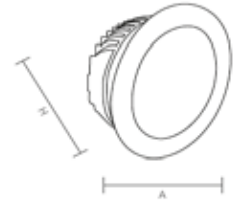

Ürün Kodu Product Code	Güç Power	Çıkış Işık Akısı Lumen Output	Verimlilik Efficiency	Işık Açısı Beam Angle	Işık Kaynağı Light Source	CRI	A (mm)	Ø CUT (mm)	H (mm)
17109	7W	700Lm	100Lm/W	120°	LED	80	108	85	65
17110	9W	900Lm	100Lm/W	120°	LED	80	128	105	55
17111	12,5W	1250Lm	100Lm/W	120°	LED	80	150	130	55
17112	25W	2500Lm	100Lm/W	120°	LED	80	200	180	55
17113	30W	3000Lm	100Lm/W	120°	LED	80	240	210	58



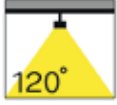

ÜRÜN ÖZELLİKLERİ/PRODUCT SPECIFICATIONS

Ürün Tanımı	Downlight Armatür	Product Descripton	Downlight Luminaire
Gövde	Alüminyum Enjeksiyon	Body	Die-Cast Aluminum
Boya		Paint	
PCB	Isı İletkenliği Yüksek PCB	PCB	High Conductive Heat -Resistance PCB
Lens		Lens	
Reflektör		Reflector	
Difüzör	Opal	Diffuser	Opal
SDCM (MacAdam)	3	SDCM (MacAdam)	3
Renk Sıcaklığı	2700K-6500K	Colour Temperature	2700K-6500K
Ömür	50000h	Life Time	50000h
Çalışma Sıcaklığı	0°C- +40°C	Operating Temperature	0°C- +40°C
LED	Osram/Philips/Cree	LED	Osram/Philips/Cree
Sürücü	Tridonic/Eaglerise	Driver	Tridonic/Eaglerise
Uygunluk	EN 60598-2-2	Conformity	EN 60598-2-2

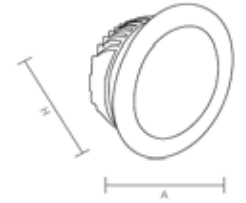

Ürün Kodu Product Code	Güç Power	Çıkış Işık Akısı Lumen Output	Verimlilik Efficiency	Işık Açısı Beam Angle	Işık Kaynağı Light Source	CRI	A (mm)	Ø CUT (mm)	H (mm)
17114	7W	700Lm	100Lm/W	120°	LED	80	97	85	55
17115	9W	900Lm	100Lm/W	120°	LED	80	117	105	48
17116	12,5W	1250Lm	100Lm/W	120°	LED	80	147	130	54
17117	25W	2500Lm	100Lm/W	120°	LED	80	192	175	55
17118	30W	3000Lm	100Lm/W	120°	LED	80	227	210	58





ÜRÜN ÖZELLİKLERİ/PRODUCT SPECIFICATIONS

Ürün Tanımı	Downlight Armatür	Product Descripton	Downlight Luminaire
Gövde	Alüminyum Enjeksiyon	Body	Die-Cast Aluminum
Boya		Paint	
PCB	Isı İletkenliği Yüksek PCB	PCB	High Conductive Heat -Resistance PCB
Lens		Lens	
Reflektör		Reflector	
Difüzör	Opal	Diffuser	Opal
SDCM (MacAdam)	3	SDCM (MacAdam)	3
Renk Sıcaklığı	2700K-6500K	Colour Temperature	2700K-6500K
Ömür	50000h	Life Time	50000h
Çalışma Sıcaklığı	0°C- +40°C	Operating Temperature	0°C- +40°C
LED	Osram/Philips/Cree	LED	Osram/Philips/Cree
Sürücü	Tridonic/Eaglerise	Driver	Tridonic/Eaglerise
Uygunluk	EN 60598-2-2	Conformity	EN 60598-2-2

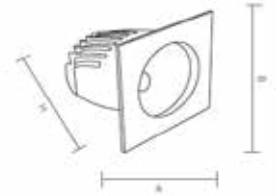

Ürün Kodu Product Code	Güç Power	Çıkış Işık Akısı Lumen Output	Verimlilik Efficiency	Işık Açısı Beam Angle	Işık Kaynağı Light Source	CRI	A/B (mm)	Ø CUT (mm)	H (mm)
17119	7W	700Lm	100Lm/W	120°	LED	80	108X108	90	65
17120	9W	900Lm	100Lm/W	120°	LED	80	128X128	105	55
17121	12,5W	1250Lm	100Lm/W	120°	LED	80	150X150	130	55
17122	25W	2500Lm	100Lm/W	120°	LED	80	200X200	180	55
17123	30W	3000Lm	100Lm/W	120°	LED	80	240X240	210	58





ÜRÜN ÖZELLİKLERİ/PRODUCT SPECIFICATIONS

Ürün Tanımı	Downlight Armatür	Product Descripton	Downlight Luminaire
Gövde	Alüminyum Enjeksiyon	Body	Die-Cast Aluminum
Boya		Paint	
PCB	Isı İletkenliği Yüksek PCB	PCB	High Conductive Heat -Resistance PCB
Lens		Lens	
Reflektör		Reflector	
Difüzör	Opal	Diffuser	Opal
SDCM (MacAdam)	3	SDCM (MacAdam)	3
Renk Sıcaklığı	2700K-6500K	Colour Temperature	2700K-6500K
Ömür	50000h	Life Time	50000h
Çalışma Sıcaklığı	0°C- +40°C	Operating Temperature	0°C- +40°C
LED	Osram/Philips/Cree	LED	Osram/Philips/Cree
Sürücü	Tridonic/Eaglerise	Driver	Tridonic/Eaglerise
Uygunluk	EN 60598-2-2	Conformity	EN 60598-2-2

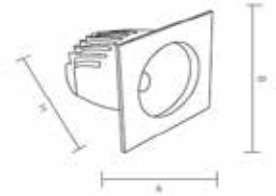

Ürün Kodu Product Code	Güç Power	Çıkış Işık Akısı Lumen Output	Verimlilik Efficiency	Işık Açısı Beam Angle	Işık Kaynağı Light Source	CRI	A/B (mm)	Ø CUT (mm)	H (mm)
17124	7W	700Lm	100Lm/W	120°	LED	80	97X97	85	55
17125	9W	900Lm	100Lm/W	120°	LED	80	117X117	105	48
17126	12,5W	1250Lm	100Lm/W	120°	LED	80	147X147	130	54
17127	25W	2500Lm	100Lm/W	120°	LED	80	195X195	180	55
17128	30W	3000Lm	100Lm/W	120°	LED	80	227X227	210	58



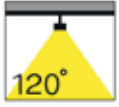

ÜRÜN ÖZELLİKLERİ/PRODUCT SPECIFICATIONS

Ürün Tanımı	Downlight Armatür	Product Descripton	Downlight Luminaire
Gövde	Alüminyum Enjeksiyon	Body	Die-Cast Aluminum
Boya		Paint	
PCB	Isı İletkenliği Yüksek PCB	PCB	High Conductive Heat -Resistance PCB
Lens		Lens	
Reflektör		Reflector	
Difüzör	Opal	Diffuser	Opal
SDCM (MacAdam)	3	SDCM (MacAdam)	3
Renk Sıcaklığı	2700K-6500K	Colour Temperature	2700K-6500K
Ömür	50000h	Life Time	50000h
Çalışma Sıcaklığı	0°C- +40°C	Operating Temperature	0°C- +40°C
LED	Osram/Philips/Cree	LED	Osram/Philips/Cree
Sürücü	Tridonic/Eaglerise	Driver	Tridonic/Eaglerise
Uygunluk	EN 60598-2-2	Conformity	EN 60598-2-2

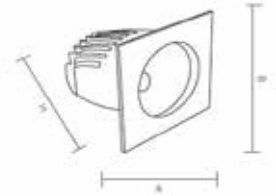

Ürün Kodu Product Code	Güç Power	Çıkış Işık Akısı Lumen Output	Verimlilik Efficiency	Işık Açısı Beam Angle	Işık Kaynağı Light Source	CRI	A/B (mm)	Ø CUT (mm)	H (mm)
17129	7W	700Lm	100Lm/W	120°	LED	80	97X97	85	70
17130	9W	900Lm	100Lm/W	120°	LED	80	117X117	105	70
17131	12,5W	1250Lm	100Lm/W	120°	LED	80	147X147	130	75
17132	12,5W	1250Lm	100Lm/W	120°	LED	80	175X175	160	85
17133	18W	1800Lm	100Lm/W	120°	LED	80	195X195	180	85
17134	25W	2500Lm	100Lm/W	120°	LED	81	227X227	210	85



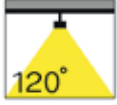

ÜRÜN ÖZELLİKLERİ/PRODUCT SPECIFICATIONS

Ürün Tanımı	Downlight Armatür	Product Descripton	Downlight Luminaire
Gövde	Alüminyum Enjeksiyon	Body	Die-Cast Aluminum
Boya		Paint	
PCB	Isı İletkenliği Yüksek PCB	PCB	High Conductive Heat -Resistance PCB
Lens		Lens	
Reflektör		Reflector	
Difüzör	Opal	Diffuser	Opal
SDCM (MacAdam)	3	SDCM (MacAdam)	3
Renk Sıcaklığı	2700K-6500K	Colour Temperature	2700K-6500K
Ömür	50000h	Life Time	50000h
Çalışma Sıcaklığı	0°C- +40°C	Operating Temperature	0°C- +40°C
LED	Osram/Philips/Cree	LED	Osram/Philips/Cree
Sürücü	Tridonic/Eaglerise	Driver	Tridonic/Eaglerise
Uygunluk	EN 60598-2-2	Conformity	EN 60598-2-2

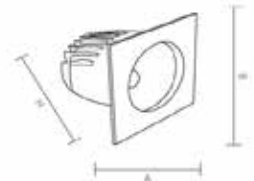

Ürün Kodu Product Code	Güç Power	Çıkış Işık Akısı Lumen Output	Verimlilik Efficiency	Işık Açısı Beam Angle	Işık Kaynağı Light Source	CRI	A/B (mm)	Ø CUT (mm)	H (mm)
17135	7W	700Lm	100Lm/W	120°	LED	80	108x108	90	65
17136	9W	900Lm	100Lm/W	120°	LED	80	128x128	105	55
17137	12,5W	1250Lm	100Lm/W	120°	LED	80	150x150	130	55
17138	25W	2500Lm	100Lm/W	120°	LED	80	200x200	180	55
17139	30W	3000Lm	100Lm/W	120°	LED	80	240x240	210	58



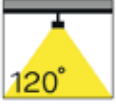

ÜRÜN ÖZELLİKLERİ/PRODUCT SPECIFICATIONS

Ürün Tanımı	Downlight Armatür	Product Description	Downlight Luminaire
Gövde	Alüminyum Döküm	Body	Aluminum Casting
Boya	Elektrostatik Toz Boya	Paint	Electrostatic Powder Coated
PCB	Isı İletkenliği Yüksek PCB	PCB	High Conductive Heat -Resistance PCB
Lens		Lens	
Reflektör		Reflector	
Difüzör	Opal	Diffuser	Opal
SDCM (MacAdam)	3	SDCM (MacAdam)	3
Renk Sıcaklığı	2700K-6500K	Colour Temperature	2700K-6500K
Ömür	50000h	Life Time	50000h
Çalışma Sıcaklığı	0°C- +40°C	Operating Temperature	0°C- +40°C
LED	Samsung	LED	Samsung
Sürücü		Driver	
Uygunluk	EN 60598-2-2	Conformity	EN 60598-2-2

Ürün Kodu Product Code	Güç Power	Çıkış Işık Akısı Lumen Output	Verimlilik Efficiency	Işık Açısı Beam Angle	Işık Kaynağı Light Source	CRI	Ø (mm)	CUT (mm)	H (mm)
92078	6W	504Lm	84Lm/W	120°	LED	80	120	104	10
92079	9W	756Lm	84Lm/W	120°	LED	80	145	130	10
92080	12W	1008Lm	84Lm/W	120°	LED	80	174	154	10
92081	18W	1512Lm	84Lm/W	120°	LED	81	225	201	10





ÜRÜN ÖZELLİKLERİ/PRODUCT SPECIFICATIONS

Ürün Tanımı	Downlight Armatür	Product Descripton	Downlight Luminaire
Gövde	Alüminyum Döküm	Body	Aluminum Casting
Boya		Paint	
PCB	Isı İletkenliği Yüksek PCB	PCB	High Conductive Heat -Resistance PCB
Lens		Lens	
Reflektör		Reflector	
Difüzör	Opal	Diffuser	Opal
SDCM (MacAdam)	3	SDCM (MacAdam)	3
Renk Sıcaklığı	2700K-6500K	Colour Temperature	2700K-6500K
Ömür	50000h	Life Time	50000h
Çalışma Sıcaklığı	0°C- +40°C	Operating Temperature	0°C- +40°C
LED	Osram/Nichia	LED	Osram/Nichia
Sürücü	Tridonic/Philips	Driver	Tridonic/Philips
Uygunluk	EN 60598-2-2	Conformity	EN 60598-2-2

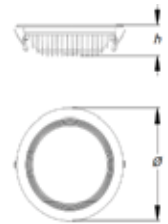

Ürün Kodu Product Code	Güç Power	Çıkış Işık Akısı Lumen Output	Verimlilik Efficiency	Işık Açısı Beam Angle	Işık Kaynağı Light Source	CRI	Ø (mm)	Ø CUT (mm)	H (mm)
17016	10W	1044Lm	104Lm/W	120°	LED	80	95	73-80	42
17017	15W	1402Lm	94Lm/W	120°	LED	80	127	97-108	46
17018	20W	2325Lm	116Lm/W	120°	LED	80	194	161-175	58
17019	30W	3235Lm	108Lm/W	120°	LED	80	222,5	193-207	54,5



Sıva Üstü Lineer



Surface Mounted Linear

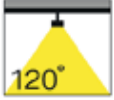

ÜRÜN ÖZELLİKLERİ/PRODUCT SPECIFICATIONS

Ürün Tanımı	Sıva Üstü Lineer Armatür	Product Description	Surface Mounted
Gövde	Alüminyum Ekstrüzyon Profil	Body	Aluminum Extrusion Profile
Boya / Kapak	Alüminyum Enjeksiyon	Paint / Cap	Aluminum Injection
Diğer Özellik		Other	
Lens		Lens	
Reflektör		Reflector	
Difüzör	Pleksi	Diffuser	Plexy
SDCM (MacAdam)	3	SDCM (MacAdam)	3
Renk Sıcaklığı	2700K/3000K/4000K	Colour Temperature	2700K/3000K/4000K
Ömür	50000h	Life Time	50000h
Çalışma Sıcaklığı	25°C	Operating Temperature	25°C
LED	Osram/Tridonic/Nichia Samsung/Cree	LED	Osram/Tridonic/Nichia Samsung/Cree
Sürücü		Sürücü	
Uygunluk	EN 60598-1 EN 60598-2-1	Conformity	EN 60598-1 EN 60598-2-1

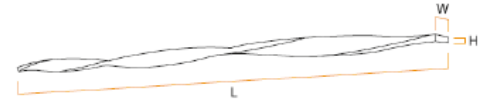

Ürün Kodu Product Code	Güç Power	Çıkış Işık Akısı Lumen Output	Verimlilik Efficiency	Işık Açısı Beam Angle	Işık Kaynağı Light Source	CRI	L (mm)	W (mm)	H (mm)
31244	26W	2600Lm	100Lm/W	120°	LED	80	1000	62	20
31245	31,2W	3120Lm	100Lm/W	120°	LED	80	1200	62	20
31246	39W	3900Lm	100Lm/W	120°	LED	80	1500	62	77
31247	52W	5200Lm	100Lm/W	120°	LED	80	2000	62	77
31248	78W	7800Lm	100Lm/W	120°	LED	80	3000	62	77
31249	26W/m	2600Lm/m	100Lm/W	120°	LED	80	∞	62	77

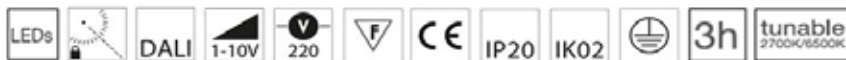

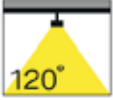

ÜRÜN ÖZELLİKLERİ/PRODUCT SPECIFICATIONS

Ürün Tanımı	Sıva Üstü Lineer Armatür	Product Description	Surface Mounted Lineer Luminaire
Gövde	Alüminyum Ekstrüzyon Profil	Body	Aluminum Extrusion Profile
Boya / Kapak	Alüminyum Enjeksiyon	Paint / Cap	Aluminum Injection
Diğer Özellik		Other	
Lens		Lens	
Reflektör		Reflector	
Difüzör	Pleksi	Diffuser	Plexy
SDCM (MacAdam)	3	SDCM (MacAdam)	3
Renk Sıcaklığı	2700K/3000K/4000K	Colour Temperature	2700K/3000K/4000K
Ömür	50000h	Life Time	50000h
Çalışma Sıcaklığı	25°C	Operating Temperature	25°C
LED	Osram/Tridonic/Nichia Samsung/Cree	LED	Osram/Tridonic/Nichia Samsung/Cree
Sürücü		Sürücü	
Uygunluk	EN 60598-1 EN 60598-2-1	Conformity	EN 60598-1 EN 60598-2-1

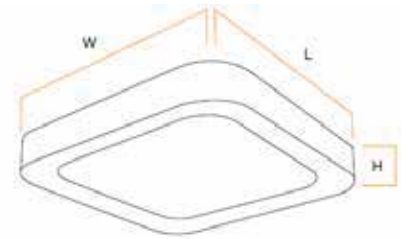

Ürün Kodu Product Code	Güç Power	Çıkış Işık Akısı Lumen Output	Verimlilik Efficiency	Işık Açısı Beam Angle	Işık Kaynağı Light Source	CRI	L (mm)	W (mm)	H (mm)
32046	10x2W	1900Lm	95Lm/W	120°	LED	80	600	600	77
32047	20x2W	3800Lm	95Lm/W	120°	LED	80	1200	1200	77
32048			90Lm/W	120°	LED	80	∞	∞	77



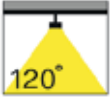
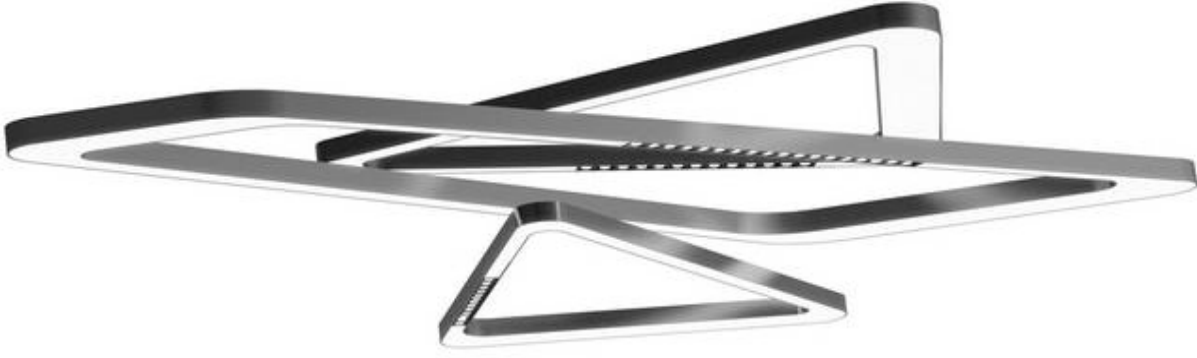

ÜRÜN ÖZELLİKLERİ/PRODUCT SPECIFICATIONS

Ürün Tanımı	Sıva Üstü Lineer Armatür	Product Descripton	Surface Mounted Lineer Luminaire
Gövde	Alüminyum Ekstrüzyon Profil	Body	Aluminum Extrusion Profile
Boya / Kapak	Alüminyum Enjeksiyon	Paint / Cap	Aluminum Injection
Diğer Özellik		Other	
Lens		Lens	
Reflektör		Reflector	
Difüzör	Pleksi	Diffuser	Plexy
SDCM (MacAdam)	3	SDCM (MacAdam)	3
Renk Sıcaklığı	2700K/3000K/4000K	Colour Temperature	2700K/3000K/4000K
Ömür	50000h	Life Time	50000h
Çalışma Sıcaklığı	25°C	Operating Temperature	25°C
LED	Osram/Tridonic/Nichia Samsung/Cree	LED	Osram/Tridonic/Nichia Samsung/Cree
Sürücü		Sürücü	
Uygunluk	EN 60598-1 EN 60598-2-1	Conformity	EN 60598-1 EN 60598-2-1



Ürün Kodu Product Code	Güç Power	Çıkış Işık Akısı Lumen Output	Verimlilik Efficiency	Işık Açısı Beam Angle	Işık Kaynağı Light Source	CRI	L/L1 (mm)	W/W1 (mm)	H (mm)
31298	45W	4095Lm	91Lm/W	120°	LED	80	720	900	50
31299	58W	5265Lm	91Lm/W	120°	LED	80	1100	990	50
31300	65W	5850Lm	90Lm/W	120°	LED	80	2200	700	50



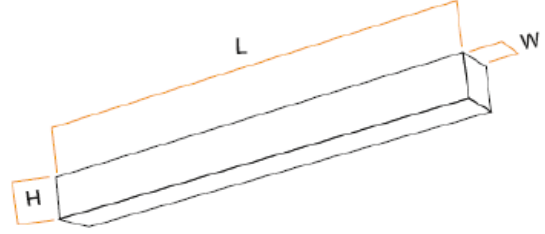

ÜRÜN ÖZELLİKLERİ/PRODUCT SPECIFICATIONS

Ürün Tanımı	Sıva Üstü Lineer Armatür	Product Description	Surface Mounted Lineer Luminaire
Gövde	Alüminyum Ekstrüzyon Profil	Body	Aluminum Extrusion Profile
Boya / Kapak	Alüminyum Enjeksiyon	Paint / Cap	Aluminum Injection
Diğer Özellik		Other	
Lens		Lens	
Reflektör		Reflector	
Difüzör	Pleksi	Diffuser	Plexi
SDCM (MacAdam)	3	SDCM (MacAdam)	3
Renk Sıcaklığı	2700K/3000K/4000K	Colour Temperature	2700K/3000K/4000K
Ömür	50000h	Life Time	50000h
Çalışma Sıcaklığı	25°C	Operating Temperature	25°C
LED	Osram/Tridonic/Nichia Samsung/Cree	LED	Osram/Tridonic/Nichia Samsung/Cree
Sürücü		Sürücü	
Uygunluk	EN 60598-1 EN 60598-2-1	Conformity	EN 60598-1 EN 60598-2-1

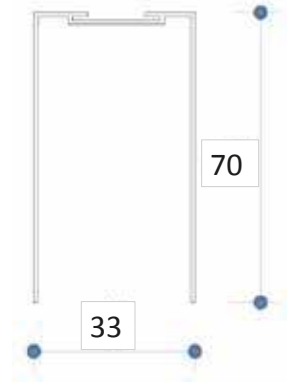

Ürün Kodu Product Code	Güç Power	Çıkış Işık Akısı Lumen Output	Verimlilik Efficiency	Işık Açısı Beam Angle	Işık Kaynağı Light Source	CRI	L (mm)	W (mm)	H (mm)
32084	2X5W	1100Lm	110Lm/W	30°	LED	80	1000	33	70
32085	3X5W	1650Lm	110Lm/W	30°	LED	80	1000	33	70
32086	4X5W	2200Lm	110Lm/W	30°	LED	80	1000	33	70
32087	4X5W	2200Lm	110Lm/W	30°	LED	80	1200	33	70
32088	5X5W	2750Lm	110Lm/W	30°	LED	80	1200	33	70
32089	6X5W	3300Lm	110Lm/W	30°	LED	80	1500	33	70
32090	∞X5W	∞XXXLm	110Lm/W	30°	LED	80	∞	33	70

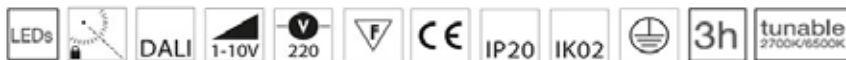

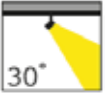
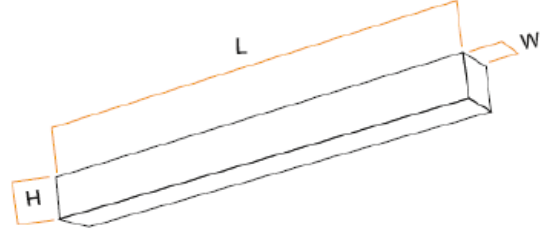

ÜRÜN ÖZELLİKLERİ/PRODUCT SPECIFICATIONS

Ürün Tanımı	Sıva Üstü Lineer Armatür	Product Description	Surface Mounted Lineer Luminaire
Gövde	Alüminyum Ekstrüzyon Profil	Body	Aluminum Extrusion Profile
Boya / Kapak	Alüminyum Enjeksiyon	Paint / Cap	Aluminum Injection
Diğer Özellik		Other	
Lens		Lens	
Reflektör		Reflector	
Difüzör	Pleksi	Diffuser	Plexy
SDCM (MacAdam)	3	SDCM (MacAdam)	3
Renk Sıcaklığı	2700K/3000K/4000K	Colour Temperature	2700K/3000K/4000K
Ömür	50000h	Life Time	50000h
Çalışma Sıcaklığı	25°C	Operating Temperature	25°C
LED	Osram/Tridonic/Nichia Samsung/Cree	LED	Osram/Tridonic/Nichia Samsung/Cree
Sürücü		Sürücü	
Uygunluk	EN 60598-1 EN 60598-2-1	Conformity	EN 60598-1 EN 60598-2-1



Ürün Kodu Product Code	Güç Power	Çıkış Işık Akısı Lumen Output	Verimlilik Efficiency	Işık Açısı Beam Angle	Işık Kaynağı Light Source	CRI	L (mm)	W (mm)	H (mm)
32062	2X7,5W	1650Lm	110Lm/W	30°	LED	80	1000	42	75
32063	3X7,5W	2475Lm	110Lm/W	30°	LED	80	1000	42	75
32064	4X7,5W	3300Lm	110Lm/W	30°	LED	80	1000	42	75
32065	4X7,5W	3300Lm	110Lm/W	30°	LED	80	1200	42	75
32066	5X7,5W	4125Lm	110Lm/W	30°	LED	80	1200	42	75
32067	6X7,5W	4950Lm	110Lm/W	30°	LED	80	1500	42	75
32068	∞X7,5W	∞XXXLm	110Lm/W	30°	LED	80	∞	42	75

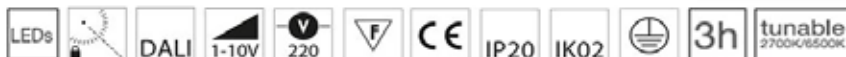

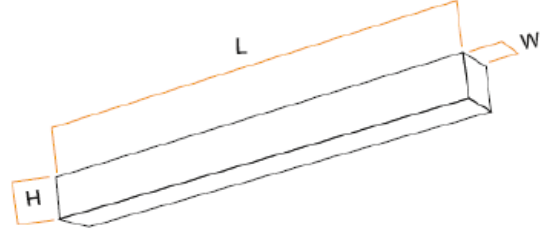

ÜRÜN ÖZELLİKLERİ/PRODUCT SPECIFICATIONS

Ürün Tanımı	Sıva Üstü Lineer Armatür	Product Description	Surface Mounted Lineer Luminaire
Gövde	Alüminyum Ekstrüzyon Profil	Body	Aluminum Extrusion Profile
Boya / Kapak	Alüminyum Enjeksiyon	Paint / Cap	Aluminum Injection
Diğer Özellik		Other	
Lens		Lens	
Reflektör		Reflector	
Difüzör	Pleksi	Diffuser	Plexy
SDCM (MacAdam)	3	SDCM (MacAdam)	3
Renk Sıcaklığı	2700K/3000K/4000K	Colour Temperature	2700K/3000K/4000K
Ömür	50000h	Life Time	50000h
Çalışma Sıcaklığı	25°C	Operating Temperature	25°C
LED	Osram/Tridonic/Nichia Samsung/Cree	LED	Osram/Tridonic/Nichia Samsung/Cree
Sürücü		Sürücü	
Uygunluk	EN 60598-1 EN 60598-2-1	Conformity	EN 60598-1 EN 60598-2-1

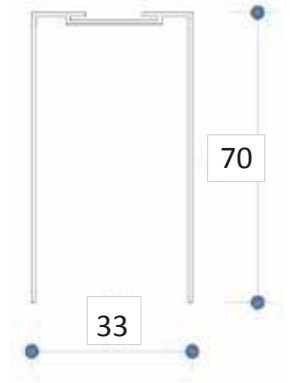

Ürün Kodu Product Code	Güç Power	Çıkış Işık Akısı Lumen Output	Verimlilik Efficiency	Işık Açısı Beam Angle	Işık Kaynağı Light Source	CRI	L (mm)	W (mm)	H (mm)
32091	2X10W	2200Lm	110Lm/W	30°	LED	80	1000	33	70
32092	3X10W	3300Lm	110Lm/W	30°	LED	80	1000	33	70
32093	4X10W	4400Lm	110Lm/W	30°	LED	80	1000	33	70
32094	4X10W	4400Lm	110Lm/W	30°	LED	80	1200	33	70
32095	5X10W	5500Lm	110Lm/W	30°	LED	80	1200	33	70
32096	6X10W	6600Lm	110Lm/W	30°	LED	80	1500	33	70
32097	∞X10W	∞XXXLm	110Lm/W	30°	LED	80	∞	33	70



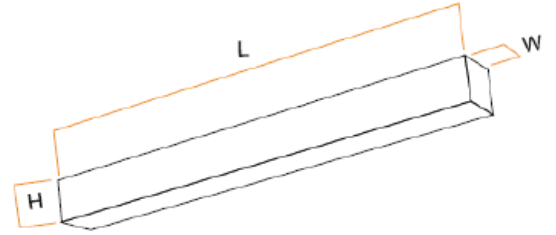

ÜRÜN ÖZELLİKLERİ/PRODUCT SPECIFICATIONS

Ürün Tanımı	Sıva Üstü Lineer Armatür	Product Description	Surface Mounted Lineer Luminaire
Gövde	Alüminyum Ekstrüzyon Profil	Body	Aluminum Extrusion Profile
Boya / Kapak	Alüminyum Enjeksiyon	Paint / Cap	Aluminum Injection
Diğer Özellik		Other	
Lens		Lens	
Reflektör		Reflector	
Difüzör	Pleksi	Diffuser	Plexy
SDCM (MacAdam)	3	SDCM (MacAdam)	3
Renk Sıcaklığı	2700K/3000K/4000K	Colour Temperature	2700K/3000K/4000K
Ömür	50000h	Life Time	50000h
Çalışma Sıcaklığı	25°C	Operating Temperature	25°C
LED	Osram/Tridonic/Nichia Samsung/Cree	LED	Osram/Tridonic/Nichia Samsung/Cree
Sürücü		Sürücü	
Uygunluk	EN 60598-1 EN 60598-2-1	Conformity	EN 60598-1 EN 60598-2-1

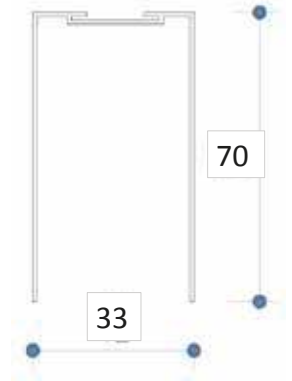

Ürün Kodu Product Code	Güç Power	Çıkış Işık Akısı Lumen Output	Verimlilik Efficiency	Işık Açısı Beam Angle	Işık Kaynağı Light Source	CRI	L (mm)	W (mm)	H (mm)
32098	38W	4560Lm	120Lm/W	30°	LED	80	1000	33	70
32099	19W	2280Lm	120Lm/W	30°	LED	80	1000	33	70
32100	38W	4560Lm	120Lm/W	30°	LED	80	1200	33	70
32101	19W	2280Lm	120Lm/W	30°	LED	80	1200	33	70
32102	57W	6840Lm	120Lm/W	30°	LED	80	1500	33	70
32103	28,5W	3420Lm	120Lm/W	30°	LED	80	1500	33	70
32104	∞X1W	∞XXXLm	Lm/W	30°	LED	80	∞	33	70
32105	∞X0,5W	∞XXXLm	Lm/W	30°	LED	81	∞	33	70



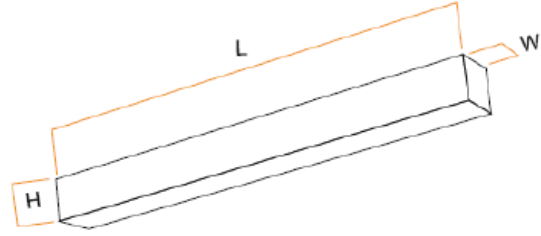

ÜRÜN ÖZELLİKLERİ/PRODUCT SPECIFICATIONS

Ürün Tanımı	Sıva Üstü Lineer Armatür	Product Description	Surface Mounted Lineer Luminaire
Gövde	Alüminyum Ekstrüzyon Profil	Body	Aluminum Extrusion Profile
Boya / Kapak	Alüminyum Enjeksiyon	Paint / Cap	Aluminum Injection
Diğer Özellik		Other	
Lens		Lens	
Reflektör		Reflector	
Difüzör	Pleksi	Diffuser	Plexi
SDCM (MacAdam)	3	SDCM (MacAdam)	3
Renk Sıcaklığı	2700K/3000K/4000K	Colour Temperature	2700K/3000K/4000K
Ömür	50000h	Life Time	50000h
Çalışma Sıcaklığı	25°C	Operating Temperature	25°C
LED	Osram/Tridonic/Nichia Samsung/Cree	LED	Osram/Tridonic/Nichia Samsung/Cree
Sürücü		Sürücü	
Uygunluk	EN 60598-1 EN 60598-2-1	Conformity	EN 60598-1 EN 60598-2-1

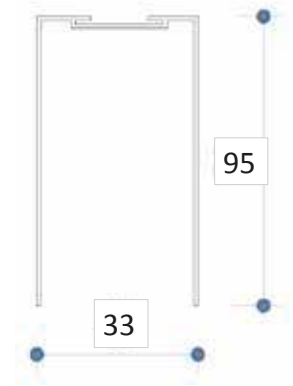

Ürün Kodu Product Code	Güç Power	Çıkış Işık Akısı Lumen Output	Verimlilik Efficiency	Işık Açısı Beam Angle	Işık Kaynağı Light Source	CRI	L (mm)	W (mm)	H (mm)
32069	2X7,5W	1650Lm	110Lm/W	30°	LED	80	1000	33	95
32070	3X7,5W	2475Lm	110Lm/W	30°	LED	80	1000	33	95
32071	4X7,5W	3300Lm	110Lm/W	30°	LED	80	1000	33	95
32072	4X7,5W	2475Lm	110Lm/W	30°	LED	80	1200	33	95
32073	5X7,5W	4125Lm	110Lm/W	30°	LED	80	1200	33	95
32074	6X7,5W	4950Lm	110Lm/W	30°	LED	80	1500	33	95
32075	∞X7,5W	∞XXXLm	110Lm/W	30°	LED	80	∞	33	95

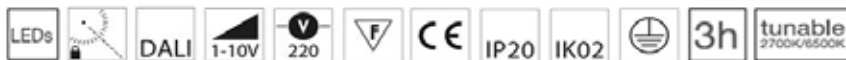

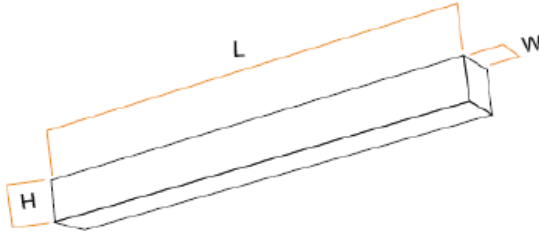
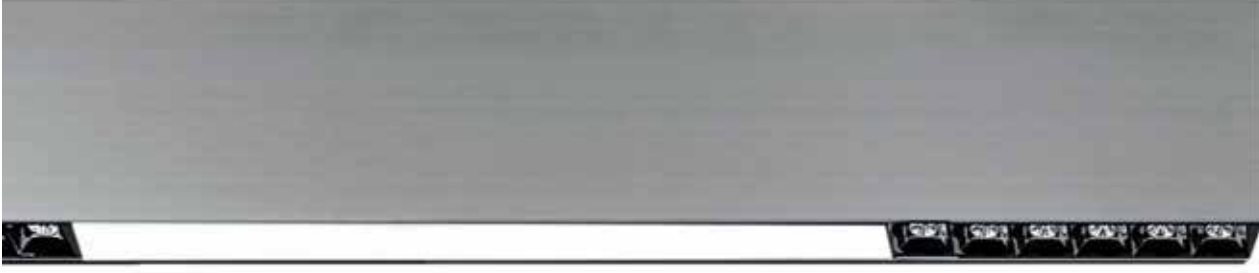

ÜRÜN ÖZELLİKLERİ/PRODUCT SPECIFICATIONS

Ürün Tanımı	Gövde	Boya / Kapak	Diğer Özellik	Lens	Reflektör	Difüzör	SDCM (MacAdam)	Renk Sıcaklığı	Ömür	Çalışma Sıcaklığı	LED	Sürücü	Uygunluk	Product Description	Body	Paint / Cap	Other	Lens	Reflector	Diffuser	SDCM (MacAdam)	Colour Temperature	Life Time	Operating Temperature	LED	Driver	Conformity
Sıva Üstü Lineer Armatür	Alüminyum Ekstrüzyon Profil	Alüminyum Enjeksiyon	Spot+Lineer Modüler Armatür		Alüminyum	Yüksek Işık Geçirgenlikli Pleksi	3	2700K/3000K/4000K	50000h	25°C	Osram/Tridonic/Nichia Samsung/Cree	Tridonic	EN 60598-1 EN 60598-2-1	Surface Mounted Lineer Luminaire	Aluminum Extrusion Profile	Aluminum Injection	Spot+Lineer Modular Luminaire		Aluminum	High Transmittance Plexy	3	2700K/3000K/4000K	50000h	25°C	Osram/Tridonic/Nichia Samsung/Cree	Tridonic	EN 60598-1 EN 60598-2-1

Ürün Kodu Product Code	Güç Power	Çıkış Işık Akısı Lumen Output	Verimlilik Efficiency	Işık Açısı Beam Angle	Işık Kaynağı Light Source	CRI	L (mm)	W (mm)	H (mm)
31311	2x6x2W+26W/m	2x6x190Lm+2080Lm/m	80Lm/W	30°+120°	LED	80	1500	33	103



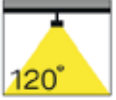

ÜRÜN ÖZELLİKLERİ/PRODUCT SPECIFICATIONS

Ürün Tanımı	Sıva Üstü Lineer Armatür	Product Description	Surface Mounted Linear Luminaire
Gövde	Alüminyum Ekstrüzyon Profil	Body	Aluminum Extrusion Profile
Boya / Kapak	Alüminyum Enjeksiyon	Paint / Cap	Aluminum Injection
Diğer Özellik		Other	
Lens		Lens	
Reflektör		Reflector	
Difüzör	Yüksek Işık Geçirgenlikli Pleksi	Diffuser	High Transmittance Plexy
SDCM (MacAdam)	3	SDCM (MacAdam)	3
Renk Sıcaklığı	2700K/3000K/4000K	Colour Temperature	2700K/3000K/4000K
Ömür	50000h	Life Time	50000h
Çalışma Sıcaklığı	25°C	Operating Temperature	25°C
LED	Osram/Tridonic/Nichia Samsung/Cree	LED	Osram/Tridonic/Nichia Samsung/Cree
Sürücü	Tridonic	Sürücü	Tridonic
Uygunluk	EN 60598-1 EN 60598-2-1	Conformity	EN 60598-1 EN 60598-2-1

NOT! ÖZEL NANO REFLEKTİF KAĞIT İLE GÜÇLENDİRİLMİŞ, %98 GERİ VERİMLİLİĞE SAHİP

NOTE! REINFORCED WITH SPECIAL NANO REFLECTIVE PAPER, %98 EFFICIENCY

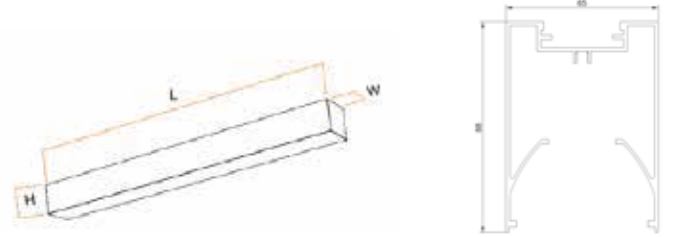

Ürün Kodu Product Code	Güç Power	Çıkış Işık Akısı Lumen Output	Verimlilik Efficiency	Işık Açısı Beam Angle	Işık Kaynağı Light Source	CRI	L (mm)	W (mm)	H (mm)
31312	26W	2470Lm	95Lm/W	120°	LED	>80	1000	65	88
31313	31,2W	2964Lm	95Lm/W	120°	LED	>80	1200	65	88
31314	39W	3705Lm	95Lm/W	120°	LED	>80	1500	65	88
31315	52W	4940Lm	95Lm/W	120°	LED	>80	2000	65	88
31316	78W	7410Lm	95Lm/W	120°	LED	>80	3000	65	88
31317	26W/m	2470Lm/m	95Lm/W	120°	LED	>80	∞	65	88

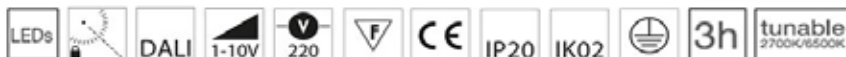

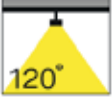

ÜRÜN ÖZELLİKLERİ/PRODUCT SPECIFICATIONS

Ürün Tanımı	Siva Üstü Lineer Armatür	Product Description	Surface Mounted Lineer
Gövde	Alüminyum Ekstrüzyon Profil	Body	Aluminum Extrusion Profile
Boya / Kapak	Alüminyum Enjeksiyon	Paint / Cap	Aluminum Injection
Diğer Özellik		Other	
Lens		Lens	
Reflektör		Reflector	
Difüzör	Pleksi	Diffuser	Plexy
SDCM (MacAdam)	3	SDCM (MacAdam)	3
Renk Sıcaklığı	2700K/3000K/4000K	Colour Temperature	2700K/3000K/4000K
Ömür	50000h	Life Time	50000h
Çalışma Sıcaklığı	25°C	Operating Temperature	25°C
LED	Osram/Tridonic/Nichia Samsung/Cree	LED	Osram/Tridonic/Nichia Samsung/Cree
Sürücü		Sürücü	
Uygunluk	EN 60598-1 EN 60598-2-1	Conformity	EN 60598-1 EN 60598-2-1



Ürün Kodu Product Code	Güç Power	Çıkış Işık Akısı Lumen Output	Verimlilik Efficiency	Işık Açısı Beam Angle	Işık Kaynağı Light Source	CRI	L (mm)	W (mm)	H (mm)
31117	20W	1500Lm	75Lm/W	120°	LED	80	1000	18	120
31118	24W	1800Lm	75Lm/W	120°	LED	80	1200	18	120
31119	30W	2250Lm	75Lm/W	120°	LED	80	1500	18	120
31120	40W	3000Lm	75Lm/W	120°	LED	80	2000	18	120
31121	60W	4500Lm	75Lm/W	120°	LED	80	3000	18	120
31122	20W/m	1500Lm/m	75Lm/W	120°	LED	80	∞	18	120



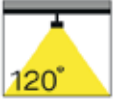
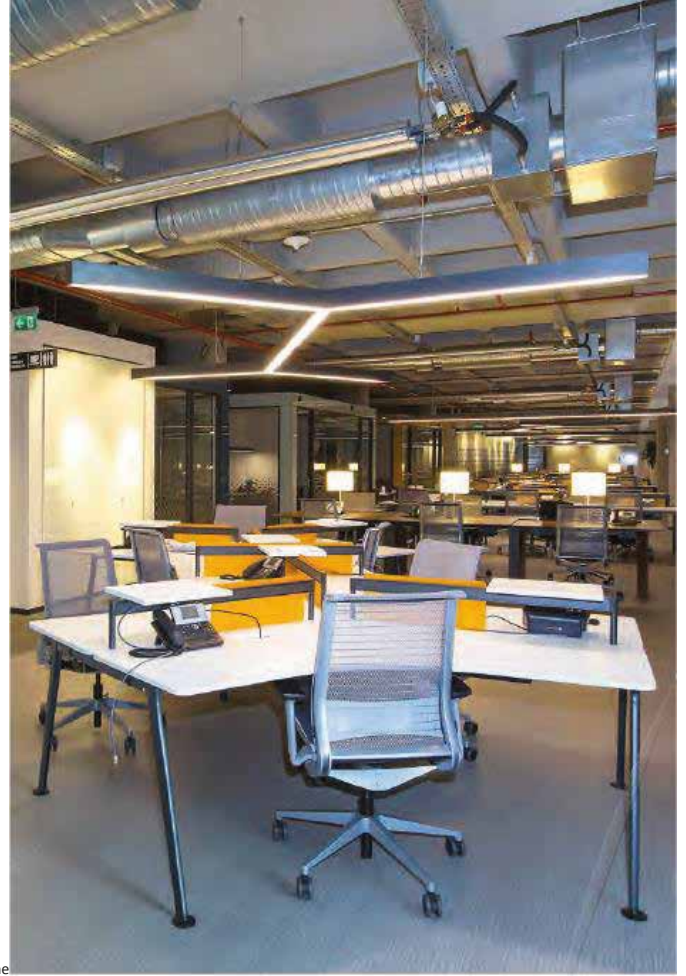

ÜRÜN ÖZELLİKLERİ/PRODUCT SPECIFICATIONS

Ürün Tanımı	Sıva Üstü Lineer Armatür	Product Description	Surface Mounted Lineer
Gövde	Alüminyum Ekstrüzyon Profil	Body	Aluminum Extrusion Profile
Boya / Kapak	Alüminyum Enjeksiyon	Paint / Cap	Aluminum Injection
Diğer Özellik		Other	
Lens		Lens	
Reflektör		Reflector	
Difüzör	Pleksi	Diffuser	Plexy
SDCM (MacAdam)	3	SDCM (MacAdam)	3
Renk Sıcaklığı	2700K/3000K/4000K	Colour Temperature	2700K/3000K/4000K
Ömür	50000h	Life Time	50000h
Çalışma Sıcaklığı	25°C	Operating Temperature	25°C
LED	Osram/Tridonic/Nichia Samsung/Cree	LED	Osram/Tridonic/Nichia Samsung/Cree
Sürücü		Sürücü	
Uygunluk	EN 60598-1 EN 60598-2-1	Conformity	EN 60598-1 EN 60598-2-1



Ürün Kodu Product Code	Güç Power	Çıkış Işık Akısı Lumen Output	Verimlilik Efficiency	Işık Açısı Beam Angle	Işık Kaynağı Light Source	CRI	L (mm)	W (mm)	H (mm)
31017	26W	2080Lm	80Lm/W	120°	LED	80	1000	65	85
31018	31,2W	2496Lm	80Lm/W	120°	LED	80	1200	65	85
31019	39W	3120Lm	80Lm/W	120°	LED	80	1500	65	85
31021	52W	4160Lm	80Lm/W	120°	LED	80	2000	65	85
31024	78W	6240Lm	80Lm/W	120°	LED	80	3000	65	85
31020	26W/m	2080Lm/m	80Lm/W	120°	LED	80	∞	65	85

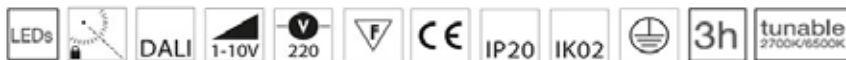

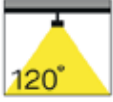

ÜRÜN ÖZELLİKLERİ/PRODUCT SPECIFICATIONS

Ürün Tanımı	Sıva Üstü Lineer Armatür	Product Description	Surface Mounted Lineer Luminaire
Gövde	Alüminyum Ekstrüzyon Profil	Body	Aluminum Extrusion Profile
Boya / Kapak	Alüminyum Enjeksiyon	Paint / Cap	Aluminum Injection
Diğer Özellik		Other	
Lens		Lens	
Reflektör		Reflector	
Difüzör	Pleksi	Diffuser	Plexy
SDCM (MacAdam)	3	SDCM (MacAdam)	3
Renk Sıcaklığı	2700K/3000K/4000K	Colour Temperature	2700K/3000K/4000K
Ömür	50000h	Life Time	50000h
Çalışma Sıcaklığı	25°C	Operating Temperature	25°C
LED	Osram/Tridonic/Nichia Samsung/Cree	LED	Osram/Tridonic/Nichia Samsung/Cree
Sürücü		Sürücü	
Uygunluk	EN 60598-1 EN 60598-2-1	Conformity	EN 60598-1 EN 60598-2-1

Ürün Kodu Product Code	Güç Power	Çıkış Işık Akısı Lumen Output	Verimlilik Efficiency	Işık Açısı Beam Angle	Işık Kaynağı Light Source	CRI	L (mm)	W (mm)	H (mm)
31147	2x26W	2x2600Lm	100Lm/W	120°	LED	80	1000	65	89
31148	2x31,2W	2x3120Lm	100Lm/W	120°	LED	80	1200	65	89
31149	2x39W	2x3900Lm	100Lm/W	120°	LED	80	1500	65	89
31150	2x52W	2x5200Lm	100Lm/W	120°	LED	80	2000	65	89
31151	2x78W	2x7800Lm	100Lm/W	120°	LED	80	3000	65	89
31152	2x26W/m	2x2600Lm/m	100Lm/W	120°	LED	80	∞	65	89



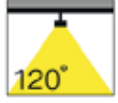

ÜRÜN ÖZELLİKLERİ/PRODUCT SPECIFICATIONS

Ürün Tanımı	Sıva Üstü Lineer Armatür	Product Description	Surface Mounted Lineer Luminaire
Gövde	Alüminyum Ekstrüzyon Profil	Body	Aluminum Extrusion Profile
Boya / Kapak	Alüminyum Enjeksiyon	Paint / Cap	Aluminum Injection
Diğer Özellik		Other	
Lens		Lens	
Reflektör		Reflector	
Difüzör	Pleksi	Diffuser	Plexy
SDCM (MacAdam)	3	SDCM (MacAdam)	3
Renk Sıcaklığı	2700K/3000K/4000K	Colour Temperature	2700K/3000K/4000K
Ömür	50000h	Life Time	50000h
Çalışma Sıcaklığı	25°C	Operating Temperature	25°C
LED	Osram/Tridonic/Nichia Samsung/Cree	LED	Osram/Tridonic/Nichia Samsung/Cree
Sürücü		Sürücü	
Uygunluk	EN 60598-1 EN 60598-2-1	Conformity	EN 60598-1 EN 60598-2-1



Ürün Kodu Product Code	Güç Power	Çıkış Işık Akısı Lumen Output	Verimlilik Efficiency	Işık Açısı Beam Angle	Işık Kaynağı Light Source	CRI	L (mm)	W (mm)	H (mm)
31069	26W	2080Lm	80Lm/W	120°	LED	80	1000	84	80
31070	31,2W	2496Lm	80Lm/W	120°	LED	80	1200	84	80
31071	39W	3120Lm	80Lm/W	120°	LED	80	1500	84	80
31072	52W	4160Lm	80Lm/W	120°	LED	80	2000	84	80
31073	78W	6240Lm	80Lm/W	120°	LED	80	3000	84	80
31074	26W/m	2080Lm/m	80Lm/W	120°	LED	80	∞	84	80

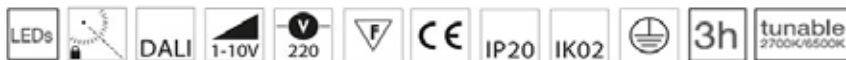

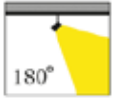

Surface-mounted / Ceiling

Pendant



ÜRÜN ÖZELLİKLERİ/PRODUCT SPECIFICATIONS

Ürün Tanımı	Sıva Üstü Lineer Armatür
Gövde	Alüminyum Ekstrüzyon Profil
Boya / Kapak	Alüminyum Enjeksiyon
Diğer Özellik	
Lens	
Reflektör	
Difüzör	Pleksi
SDCM (MacAdam)	3
Renk Sıcaklığı	2700K/3000K/4000K
Ömür	50000h
Çalışma Sıcaklığı	25°C
LED	Osram/Tridonic/Nichia Samsung/Cree
Sürücü	Tridonic
Uygunluk	EN 60598-1 EN 60598-2-1

Product Descripton	Surface Mounted Lineer Luminaire
Body	Aluminum Extrusion Profile
Paint / Cap	Aluminum Injection
Other	
Lens	
Reflector	
Diffuser	Plexy
SDCM (MacAdam)	3
Colour Temperature	2700K/3000K/4000K
Life Time	50000h
Operating Temperature	25°C
LED	Osram/Tridonic/Nichia Samsung/Cree
Sürücü	Tridonic
Conformity	EN 60598-1 EN 60598-2-1

Ürün Kodu Product Code	Güç Power	Çıkış Işık Akısı Lumen Output	Verimlilik Efficiency	Işık Açısı Beam Angle	Işık Kaynağı Light Source	CRI	L (mm)	W (mm)	H (mm)
32081	20W	2100Lm	105Lm/W	180°	LED	>80	1000	33	33
32082	30W	3300Lm	110Lm/W	180°	LED	>80	1000	33	33



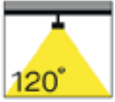

ÜRÜN ÖZELLİKLERİ/PRODUCT SPECIFICATIONS

Ürün Tanımı	Sıva Üstü Lineer Armatür	Product Description	Surface Mounted Lineer Luminaire
Gövde	Alüminyum Ekstrüzyon Profil	Body	Aluminum Extrusion Profile
Boya / Kapak	Alüminyum Enjeksiyon	Paint / Cap	Aluminum Injection
Diğer Özellik		Other	
Lens		Lens	
Reflektör		Reflector	
Difüzör	Pleksi	Diffuser	Plexy
SDCM (MacAdam)	3	SDCM (MacAdam)	3
Renk Sıcaklığı	2700K/3000K/4000K	Colour Temperature	2700K/3000K/4000K
Ömür	50000h	Life Time	50000h
Çalışma Sıcaklığı	25°C	Operating Temperature	25°C
LED	Osram/Tridonic/Nichia Samsung/Cree	LED	Osram/Tridonic/Nichia Samsung/Cree
Sürücü		Sürücü	
Uygunluk	EN 60598-1 EN 60598-2-1	Conformity	EN 60598-1 EN 60598-2-1

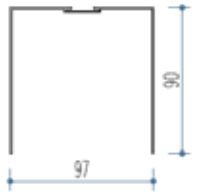

Ürün Kodu Product Code	Güç Power	Çıkış Işık Akısı Lumen Output	Verimlilik Efficiency	Işık Açısı Beam Angle	Işık Kaynağı Light Source	CRI	L (mm)	W (mm)	H (mm)
31076	26W	2080Lm	80Lm/W	120°	LED	80	1000	97	90
31077	31,2W	2496Lm	80Lm/W	120°	LED	80	1200	97	90
31078	39W	3120Lm	80Lm/W	120°	LED	80	1500	97	90
31079	52W	4160Lm	80Lm/W	120°	LED	80	2000	97	90
31080	78W	6240Lm	80Lm/W	120°	LED	80	3000	97	90
31081	26W/m	2080Lm/m	80Lm/W	120°	LED	80	∞	97	90

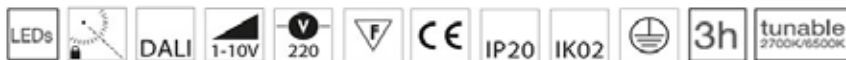

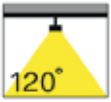
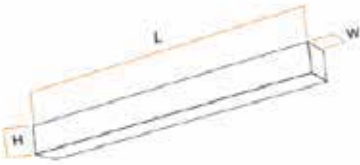

ÜRÜN ÖZELLİKLERİ/PRODUCT SPECIFICATIONS

Ürün Tanımı	Sıva Üstü Lineer Armatür
Gövde	Alüminyum Ekstrüzyon Profil
Boya / Kapak	Alüminyum Enjeksiyon
Diğer Özellik	
Lens	
Reflektör	
Difüzör	Pleksi
SDCM (MacAdam)	3
Renk Sıcaklığı	2700K/3000K/4000K
Ömür	50000h
Çalışma Sıcaklığı	25°C
LED	Osram/Tridonic/Nichia Samsung/Cree
Sürücü	Tridonic
Uygunluk	EN 60598-1 EN 60598-2-1

Product Descripton	Surface Mounted Lineer Luminaire
Body	Aluminum Extrusion Profile
Paint / Cap	Aluminum Injection
Other	
Lens	
Reflector	
Diffuser	Plexy
SDCM (MacAdam)	3
Colour Temperature	2700K/3000K/4000K
Life Time	50000h
Operating Temperature	25°C
LED	Osram/Tridonic/Nichia Samsung/Cree
Sürücü	Tridonic
Conformity	EN 60598-1 EN 60598-2-1

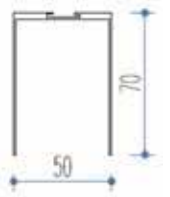

Ürün Kodu Product Code	Güç Power	Çıkış Işık Akısı Lumen Output	Verimlilik Efficiency	Işık Açısı Beam Angle	Işık Kaynağı Light Source	CRI	L (mm)	W (mm)	H (mm)
31009	26W	2080Lm	80Lm/W	120°	LED	>80	1000	50	70
31010	31,2W	2496Lm	80Lm/W	120°	LED	>80	1200	50	70
31011	39W	3120Lm	80Lm/W	120°	LED	>80	1500	50	70
31013	52W	4160Lm	80Lm/W	120°	LED	>80	2000	50	70
31016	78W	6240Lm	80Lm/W	120°	LED	>80	3000	50	70
31012	26W/m	2080Lm/m	80Lm/W	120°	LED	>80	∞	50	70



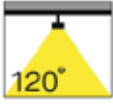

ÜRÜN ÖZELLİKLERİ/PRODUCT SPECIFICATIONS

Ürün Tanımı	Siva Üstü Lineer Armatür	Product Description	Surface Mounted Linear Luminaire
Gövde	Alüminyum Ekstrüzyon Profil	Body	Aluminum Extrusion Profile
Boya / Kapak	Alüminyum Enjeksiyon	Paint / Cap	Aluminum Injection
Diğer Özellik		Other	
Lens		Lens	
Reflektör		Reflector	
Difüzör	Pleksi	Diffuser	Plexy
SDCM (MacAdam)	3	SDCM (MacAdam)	3
Renk Sıcaklığı	2700K/3000K/4000K	Colour Temperature	2700K/3000K/4000K
Ömür	50000h	Life Time	50000h
Çalışma Sıcaklığı	25°C	Operating Temperature	25°C
LED	Osram/Tridonic/Nichia Samsung/Cree	LED	Osram/Tridonic/Nichia Samsung/Cree
Sürücü		Sürücü	
Uygunluk	EN 60598-1 EN 60598-2-1	Conformity	EN 60598-1 EN 60598-2-1

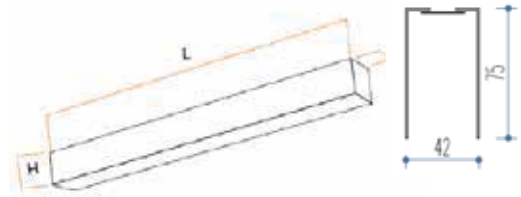

Ürün Kodu Product Code	Güç Power	Çıkış Işık Akısı Lumen Output	Verimlilik Efficiency	Işık Açısı Beam Angle	Işık Kaynağı Light Source	CRI	L (mm)	W (mm)	H (mm)
31331	26W	2080Lm	80Lm/W	120°	LED	80	1000	42	75
31332	31,2W	2496Lm	80Lm/W	120°	LED	80	1200	42	75
31333	39W	3120Lm	80Lm/W	120°	LED	80	1500	42	75
31334	52W	4160Lm	80Lm/W	120°	LED	80	2000	42	75
31335	78W	6240Lm	80Lm/W	120°	LED	80	3000	42	75
31336	26W/m	2080Lm/m	80Lm/W	120°	LED	80	∞	42	75

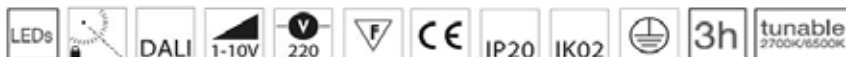

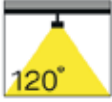

ÜRÜN ÖZELLİKLERİ/PRODUCT SPECIFICATIONS

Ürün Tanımı	Siva Üstü Lineer Armatür	Product Description	Surface Mounted Lineer Luminaire
Gövde	Alüminyum Ekstrüzyon Profil	Body	Aluminum Extrusion Profile
Boya / Kapak	Alüminyum Enjeksiyon	Paint / Cap	Aluminum Injection
Diğer Özellik		Other	
Lens		Lens	
Reflektör		Reflector	
Difüzör	Pleksi	Diffuser	Plexy
SDCM (MacAdam)	3	SDCM (MacAdam)	3
Renk Sıcaklığı	2700K/3000K/4000K	Colour Temperature	2700K/3000K/4000K
Ömür	50000h	Life Time	50000h
Çalışma Sıcaklığı	25°C	Operating Temperature	25°C
LED	Osram/Tridonic/Nichia Samsung/Cree	LED	Osram/Tridonic/Nichia Samsung/Cree
Sürücü		Sürücü	
Uygunluk	EN 60598-1 EN 60598-2-1	Conformity	EN 60598-1 EN 60598-2-1

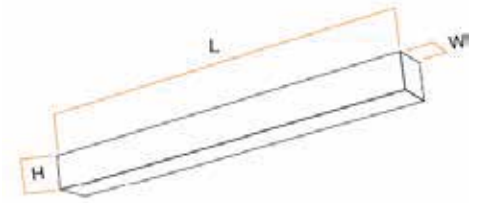

Ürün Kodu Product Code	Güç Power	Çıkış Işık Akısı Lumen Output	Verimlilik Efficiency	Işık Açısı Beam Angle	Işık Kaynağı Light Source	CRI	L (mm)	W (mm)	H (mm)
31135	26W	2600Lm	100Lm/W	120°	LED	80	1000	80	100
31136	31,2W	3120Lm	100Lm/W	120°	LED	80	1200	80	100
31137	39W	3900Lm	100Lm/W	120°	LED	80	1500	80	100
31138	52W	5200Lm	100Lm/W	120°	LED	80	2000	80	100
31139	78W	7800Lm	100Lm/W	120°	LED	80	3000	80	100
31140	26W/m	2600Lm/m	100Lm/W	120°	LED	80	∞	80	100



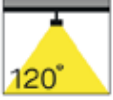

ÜRÜN ÖZELLİKLERİ/PRODUCT SPECIFICATIONS

Ürün Tanımı	Siva Üstü Lineer Armatür	Product Description	Surface Mounted Linear Luminaire
Gövde	Alüminyum Ekstrüzyon Profil	Body	Aluminum Extrusion Profile
Boya / Kapak	Alüminyum Enjeksiyon	Paint / Cap	Aluminum Injection
Diğer Özellik		Other	
Lens		Lens	
Reflektör		Reflector	
Difüzör	Pleksi	Diffuser	Plexy
SDCM (MacAdam)	3	SDCM (MacAdam)	3
Renk Sıcaklığı	2700K/3000K/4000K	Colour Temperature	2700K/3000K/4000K
Ömür	50000h	Life Time	50000h
Çalışma Sıcaklığı	25°C	Operating Temperature	25°C
LED	Osram/Tridonic/Nichia Samsung/Cree	LED	Osram/Tridonic/Nichia Samsung/Cree
Sürücü		Sürücü	
Uygunluk	EN 60598-1 EN 60598-2-1	Conformity	EN 60598-1 EN 60598-2-1

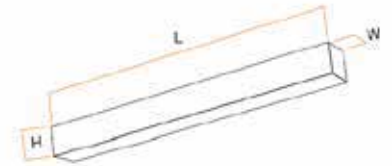

Ürün Kodu Product Code	Güç Power	Çıkış Işık Akısı Lumen Output	Verimlilik Efficiency	Işık Açısı Beam Angle	Işık Kaynağı Light Source	CRI	L (mm)	W (mm)	H (mm)
31123	26W	2600Lm	100Lm/W	120°	LED	80	1000	30	40
31124	31,2W	3120Lm	100Lm/W	120°	LED	80	1200	30	40
31125	39W	3900Lm	100Lm/W	120°	LED	80	1500	30	40
31126	52W	5200Lm	100Lm/W	120°	LED	80	2000	30	40
31127	78W	7800Lm	100Lm/W	120°	LED	80	3000	30	40
31128	26W/m	2600Lm/m	100Lm/W	120°	LED	80	∞	30	40

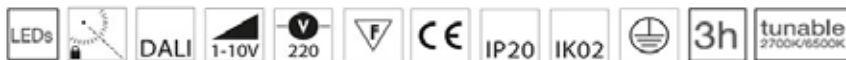

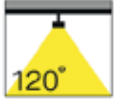
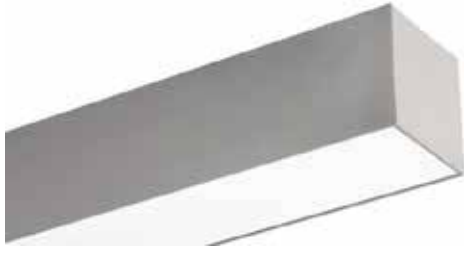

ÜRÜN ÖZELLİKLERİ/PRODUCT SPECIFICATIONS

Ürün Tanımı	Siva Üstü Lineer Armatür	Product Description	Surface Mounted
Gövde	Alüminyum Ekstrüzyon Profil	Body	Aluminum Extrusion Profile
Boya / Kapak	Alüminyum Enjeksiyon	Paint / Cap	Aluminum Injection
Diğer Özellik		Other	
Lens		Lens	
Reflektör		Reflector	
Difüzör	Pleksi	Diffuser	Plexy
SDCM (MacAdam)	3	SDCM (MacAdam)	3
Renk Sıcaklığı	2700K/3000K/4000K	Colour Temperature	2700K/3000K/4000K
Ömür	50000h	Life Time	50000h
Çalışma Sıcaklığı	25°C	Operating Temperature	25°C
LED	Osram/Tridonic/Nichia Samsung/Cree	LED	Osram/Tridonic/Nichia Samsung/Cree
Sürücü		Sürücü	
Uygunluk	EN 60598-1 EN 60598-2-1	Conformity	EN 60598-1 EN 60598-2-1



Ürün Kodu Product Code	Güç Power	Çıkış Işık Akısı Lumen Output	Verimlilik Efficiency	Işık Açısı Beam Angle	Işık Kaynağı Light Source	CRI	L (mm)	W (mm)	H (mm)
31304	26W	2080Lm	80Lm/W	120°	LED	80	1000	125	100
31082	31,2W	2496Lm	80Lm/W	120°	LED	80	1200	125	100
31083	39W	3120Lm	80Lm/W	120°	LED	80	1500	125	100
31084	52W	4160Lm	80Lm/W	120°	LED	80	2000	125	100
31085	78W	6240Lm	80Lm/W	120°	LED	80	3000	125	100
31086	26W/m	2080Lm/m	80Lm/W	120°	LED	80	∞	125	100

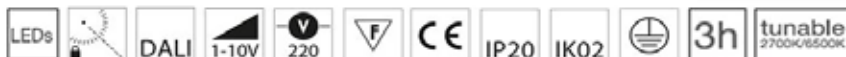

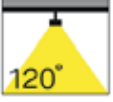
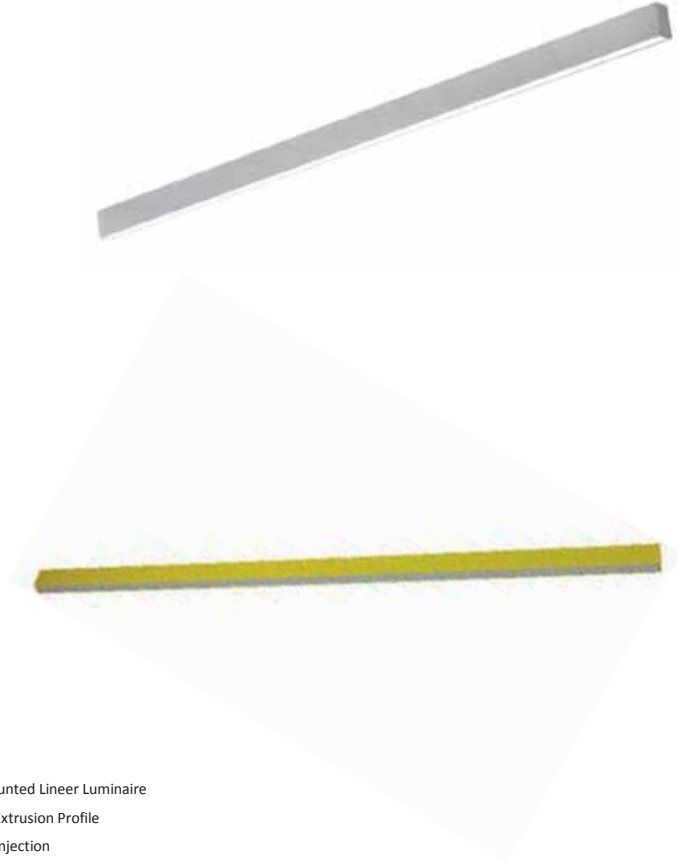

ÜRÜN ÖZELLİKLERİ/PRODUCT SPECIFICATIONS

Ürün Tanımı	Siva Üstü Lineer Armatür	Product Description	Surface Mounted Lineer Luminaire
Gövde	Alüminyum Ekstrüzyon Profil	Body	Aluminum Extrusion Profile
Boya / Kapak	Alüminyum Enjeksiyon	Paint / Cap	Aluminum Injection
Diğer Özellik		Other	
Lens		Lens	
Reflektör		Reflector	
Difüzör	Pleksi	Diffuser	Plexy
SDCM (MacAdam)	3	SDCM (MacAdam)	3
Renk Sıcaklığı	2700K/3000K/4000K	Colour Temperature	2700K/3000K/4000K
Ömür	50000h	Life Time	50000h
Çalışma Sıcaklığı	25°C	Operating Temperature	25°C
LED	Osram/Tridonic/Nichia Samsung/Cree	LED	Osram/Tridonic/Nichia Samsung/Cree
Sürücü		Sürücü	
Uygunluk	EN 60598-1 EN 60598-2-1	Conformity	EN 60598-1 EN 60598-2-1

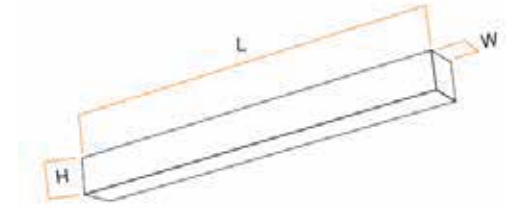

Ürün Kodu Product Code	Güç Power	Çıkış Işık Akısı Lumen Output	Verimlilik Efficiency	Işık Açısı Beam Angle	Işık Kaynağı Light Source	CRI	L (mm)	W (mm)	H (mm)
31129	26W	2600Lm	100Lm/W	120°	LED	80	1000	30	50
31130	31,2W	3120Lm	100Lm/W	120°	LED	80	1200	30	50
31131	39W	3900Lm	100Lm/W	120°	LED	80	1500	30	50
31132	52W	5200Lm	100Lm/W	120°	LED	80	2000	30	50
31133	78W	7800Lm	100Lm/W	120°	LED	80	3000	30	50
31134	26W/m	2600Lm/m	100Lm/W	120°	LED	80	∞	30	50



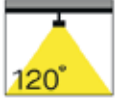

ÜRÜN ÖZELLİKLERİ/PRODUCT SPECIFICATIONS

Ürün Tanımı	Siva Üstü Lineer Armatür	Product Description	Surface Mounted Lineer Luminaire
Gövde	Alüminyum Ekstrüzyon Profil	Body	Aluminum Extrusion Profile
Boya / Kapak	Alüminyum Enjeksiyon	Paint / Cap	Aluminum Injection
Diğer Özellik		Other	
Lens		Lens	
Reflektör		Reflector	
Difüzör	Pleksi	Diffuser	Plexy
SDCM (MacAdam)	3	SDCM (MacAdam)	3
Renk Sıcaklığı	2700K/3000K/4000K	Colour Temperature	2700K/3000K/4000K
Ömür	50000h	Life Time	50000h
Çalışma Sıcaklığı	25°C	Operating Temperature	25°C
LED	Osram/Tridonic/Nichia Samsung/Cree	LED	Osram/Tridonic/Nichia Samsung/Cree
Sürücü		Sürücü	
Uygunluk	EN 60598-1 EN 60598-2-1	Conformity	EN 60598-1 EN 60598-2-1

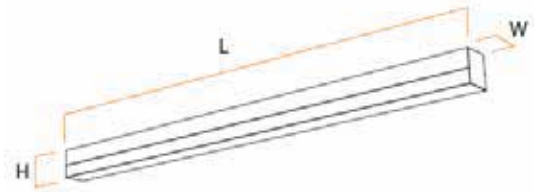

Ürün Kodu Product Code	Güç Power	Çıkış Işık Akısı Lumen Output	Verimlilik Efficiency	Işık Açısı Beam Angle	Işık Kaynağı Light Source	CRI	L (mm)	W (mm)	H (mm)
31287	26W	2600Lm	100Lm/W	120°	LED	80	1000	30	50
31288	31,2W	3120Lm	100Lm/W	120°	LED	80	1200	30	50
31289	39W	3900Lm	100Lm/W	120°	LED	80	1500	30	50
31290	52W	5200Lm	100Lm/W	120°	LED	80	2000	30	50
31291	78W	7800Lm	100Lm/W	120°	LED	80	3000	30	50
31292	26W/m	2600Lm/m	100Lm/W	120°	LED	80	∞	30	50

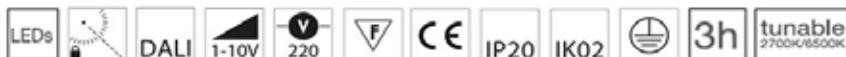

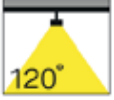
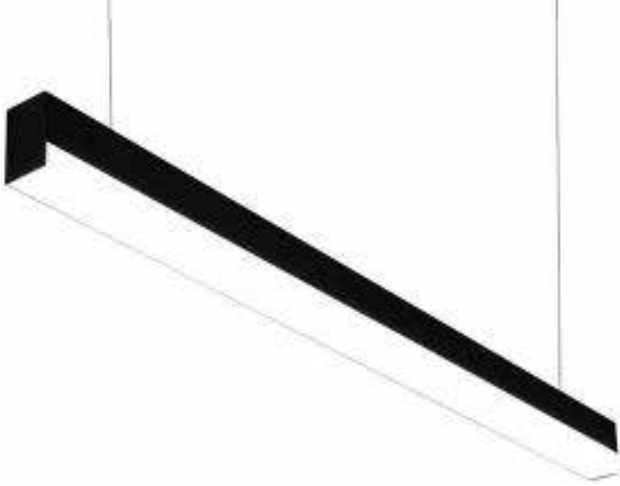

ÜRÜN ÖZELLİKLERİ/PRODUCT SPECIFICATIONS

Ürün Tanımı	Sıva Üstü Lineer Armatür	Product Description	Surface Mounted Lineer Luminaire
Gövde	Alüminyum Ekstrüzyon Profil	Body	Aluminum Extrusion Profile
Boya / Kapak	Alüminyum Enjeksiyon	Paint / Cap	Aluminum Injection
Diğer Özellik		Other	
Lens		Lens	
Reflektör		Reflector	
Difüzör	Pleksi	Diffuser	Plexy
SDCM (MacAdam)	3	SDCM (MacAdam)	3
Renk Sıcaklığı	2700K/3000K/4000K	Colour Temperature	2700K/3000K/4000K
Ömür	50000h	Life Time	50000h
Çalışma Sıcaklığı	25°C	Operating Temperature	25°C
LED	Osram/Tridonic/Nichia Samsung/Cree	LED	Osram/Tridonic/Nichia Samsung/Cree
Sürücü		Sürücü	
Uygunluk	EN 60598-1 EN 60598-2-1	Conformity	EN 60598-1 EN 60598-2-1



Ürün Kodu Product Code	Güç Power	Çıkış Işık Akısı Lumen Output	Verimlilik Efficiency	Işık Açısı Beam Angle	Işık Kaynağı Light Source	CRI	L (mm)	W (mm)	H (mm)
31093	26W	2080Lm	80Lm/W	120°	LED	80	1000	50	85
31094	31,2W	2496Lm	80Lm/W	120°	LED	80	1200	50	85
31095	39W	3120Lm	80Lm/W	120°	LED	80	1500	50	85
31096	52W	4160Lm	80Lm/W	120°	LED	80	2000	50	85
31097	78W	6240Lm	80Lm/W	120°	LED	80	3000	50	85
31098	26W/m	2080Lm/m	80Lm/W	120°	LED	80	∞	50	85

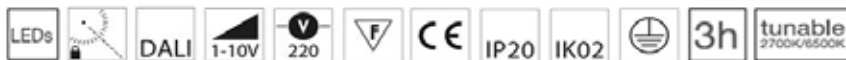

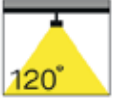

ÜRÜN ÖZELLİKLERİ/PRODUCT SPECIFICATIONS

Ürün Tanımı	Siva Üstü Lineer Armatür	Product Description	Surface Mounted Lineer Luminaire
Gövde	Alüminyum Ekstrüzyon Profil	Body	Aluminum Extrusion Profile
Boya / Kapak	Alüminyum Enjeksiyon	Paint / Cap	Aluminum Injection
Diğer Özellik		Other	
Lens		Lens	
Reflektör		Reflector	
Difüzör	Pleksi	Diffuser	Plexy
SDCM (MacAdam)	3	SDCM (MacAdam)	3
Renk Sıcaklığı	2700K/3000K/4000K	Colour Temperature	2700K/3000K/4000K
Ömür	50000h	Life Time	50000h
Çalışma Sıcaklığı	25°C	Operating Temperature	25°C
LED	Osram/Tridonic/Nichia Samsung/Cree	LED	Osram/Tridonic/Nichia Samsung/Cree
Sürücü		Sürücü	
Uygunluk	EN 60598-1 EN 60598-2-1	Conformity	EN 60598-1 EN 60598-2-1

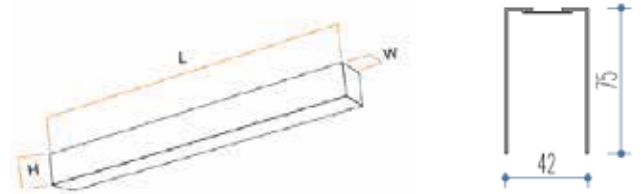

Ürün Kodu Product Code	Güç Power	Çıkış Işık Akısı Lumen Output	Verimlilik Efficiency	Işık Açısı Beam Angle	Işık Kaynağı Light Source	CRI	L (mm)	W (mm)	H (mm)
31087	26W	2080Lm	80Lm/W	120°	LED	80	1000	42	75
31088	31,2W	2496Lm	80Lm/W	120°	LED	80	1200	42	75
31089	39W	3120Lm	80Lm/W	120°	LED	80	1500	42	75
31090	52W	4160Lm	80Lm/W	120°	LED	80	2000	42	75
31091	78W	6240Lm	80Lm/W	120°	LED	80	3000	42	75
31092	26W/m	2080Lm/m	80Lm/W	120°	LED	80	∞	42	75



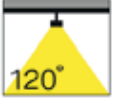
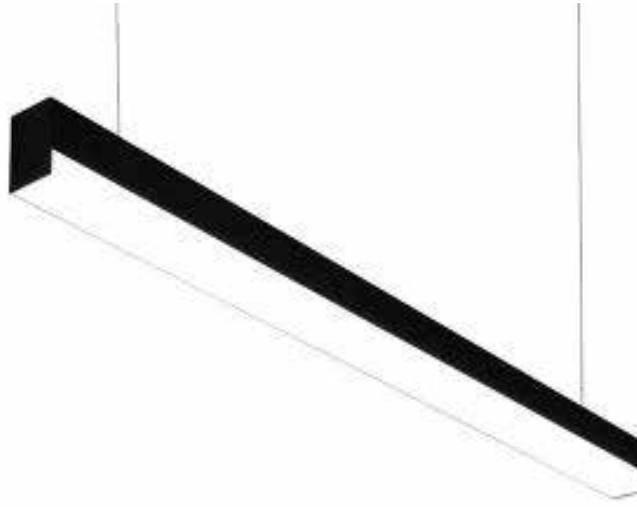
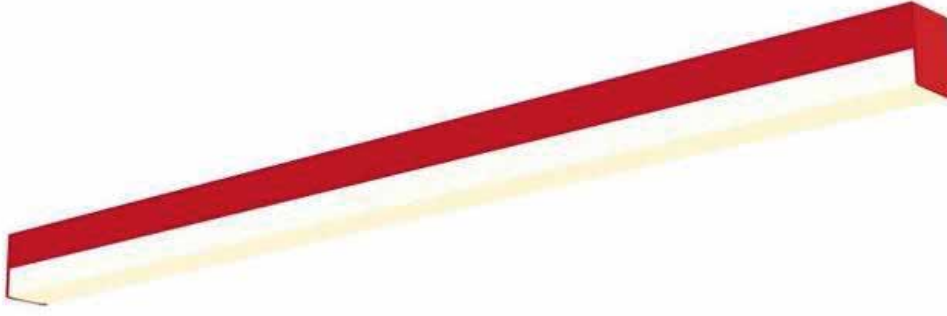

ÜRÜN ÖZELLİKLERİ/PRODUCT SPECIFICATIONS

Ürün Tanımı	Siva Üstü Lineer Armatür	Product Description	Surface Mounted Lineer Luminaire
Gövde	Alüminyum Ekstrüzyon Profil	Body	Aluminum Extrusion Profile
Boya / Kapak	Alüminyum Enjeksiyon	Paint / Cap	Aluminum Injection
Diğer Özellik		Other	
Lens		Lens	
Reflektör		Reflector	
Difüzör	Pleksi	Diffuser	Plexy
SDCM (MacAdam)	3	SDCM (MacAdam)	3
Renk Sıcaklığı	2700K/3000K/4000K	Colour Temperature	2700K/3000K/4000K
Ömür	50000h	Life Time	50000h
Çalışma Sıcaklığı	25°C	Operating Temperature	25°C
LED	Osram/Tridonic/Nichia Samsung/Cree	LED	Osram/Tridonic/Nichia Samsung/Cree
Sürücü		Sürücü	
Uygunluk	EN 60598-1 EN 60598-2-1	Conformity	EN 60598-1 EN 60598-2-1



Ürün Kodu Product Code	Güç Power	Çıkış Işık Akısı Lumen Output	Verimlilik Efficiency	Işık Açısı Beam Angle	Işık Kaynağı Light Source	CRI	L (mm)	W (mm)	H (mm)
31099	26W	2600Lm	100Lm/W	120°	LED	80	1000	57	70
31100	31,2W	3120Lm	100Lm/W	120°	LED	80	1200	57	70
31101	39W	3900Lm	100Lm/W	120°	LED	80	1500	57	70
31102	52W	5200Lm	100Lm/W	120°	LED	80	2000	57	70
31103	78W	7800Lm	100Lm/W	120°	LED	80	3000	57	70
31104	26W/m	2600Lm/m	100Lm/W	120°	LED	80	∞	57	70



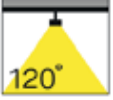

ÜRÜN ÖZELLİKLERİ/PRODUCT SPECIFICATIONS

Ürün Tanımı	Siva Üstü Lineer Armatür	Product Description	Surface Mounted Lineer Luminaire
Gövde	Alüminyum Ekstrüzyon Profil	Body	Aluminum Extrusion Profile
Boya / Kapak	Alüminyum Enjeksiyon	Paint / Cap	Aluminum Injection
Diğer Özellik		Other	
Lens		Lens	
Reflektör		Reflector	
Difüzör	Pleksi	Diffuser	Plexy
SDCM (MacAdam)	3	SDCM (MacAdam)	3
Renk Sıcaklığı	2700K/3000K/4000K	Colour Temperature	2700K/3000K/4000K
Ömür	50000h	Life Time	50000h
Çalışma Sıcaklığı	25°C	Operating Temperature	25°C
LED	Osram/Tridonic/Nichia Samsung/Cree	LED	Osram/Tridonic/Nichia Samsung/Cree
Sürücü		Sürücü	
Uygunluk	EN 60598-1 EN 60598-2-1	Conformity	EN 60598-1 EN 60598-2-1

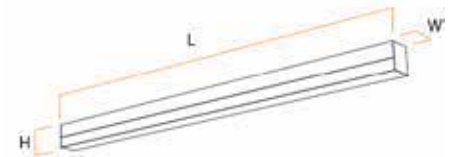

Ürün Kodu Product Code	Güç Power	Çıkış Işık Akısı Lumen Output	Verimlilik Efficiency	Işık Açısı Beam Angle	Işık Kaynağı Light Source	CRI	L (mm)	W (mm)	H (mm)
31105	52W	4660Lm	90Lm/W	120°	LED	80	1000	80	80
31106	62,4W	5592Lm	90Lm/W	120°	LED	80	1200	80	80
31107	78W	3900Lm	90Lm/W	120°	LED	80	1500	80	80
31108	52W	6990Lm	90Lm/W	120°	LED	80	2000	80	80
31109	156W	13980Lm	90Lm/W	120°	LED	80	3000	80	80
31110	52W/m	4660Lm/m	90Lm/W	120°	LED	80	∞	80	80



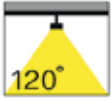

ÜRÜN ÖZELLİKLERİ/PRODUCT SPECIFICATIONS

Ürün Tanımı	Sıva Üstü Yüzük Lineer Armatür	Product Descripton	Surface Mounted Ring Lineer Luminaire
Gövde	Alüminyum Ekstrüzyon Profil	Body	Aluminum Extrusion Profile
Boya / Kapak	Alüminyum Enjeksiyon	Paint / Cap	Aluminum Injection
Diğer Özellik		Other	
Lens		Lens	
Reflektör		Reflector	
Difüzör	Pleksi	Diffuser	Plexy
SDCM (MacAdam)	3	SDCM (MacAdam)	3
Renk Sıcaklığı	2700K/3000K/4000K	Colour Temperature	2700K/3000K/4000K
Ömür	50000h	Life Time	50000h
Çalışma Sıcaklığı	25°C	Operating Temperature	25°C
LED	Osram/Tridonic/Nichia Samsung/Cree	LED	Osram/Tridonic/Nichia Samsung/Cree
Sürücü		Driver	
Uygunluk	EN 60598-1 EN 60598-2-1	Conformity	EN 60598-1 EN 60598-2-1

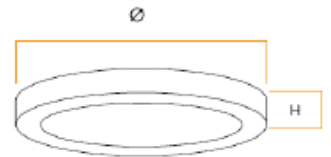

Ürün Kodu Product Code	Güç Power	Çıkış Işık Akısı Lumen Output	Verimlilik Efficiency	Işık Açısı Beam Angle	Işık Kaynağı Light Source	CRI	Ø (mm)	W (mm)	H (mm)
31037	45,5W	4275Lm	94m/W	120°	LED	80	600	100	77
31038	65W	5850Lm	90Lm/W	120°	LED	80	900	100	77
31039	71,5W	6390Lm	89Lm/W	120°	LED	80	1000	100	77
31040	84,5W	7560Lm	89Lm/W	120°	LED	80	1200	100	77
31041	100W	8900Lm	89Lm/W	120°	LED	80	1500	100	77
31042	207W	18423Lm	89Lm/W	120°	LED	80	3000	100	77
31043				120°	LED	80	∞	100	77



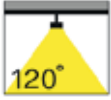

ÜRÜN ÖZELLİKLERİ/PRODUCT SPECIFICATIONS

Ürün Tanımı	Siva Üstü Halka Lineer Armatür	Product Descripton	Surface Mounted Ring Lineer Luminaire
Gövde	Alüminyum Ekstrüzyon Profil	Body	Aluminum Extrusion Profile
Boya / Kapak	Alüminyum Enjeksiyon	Paint / Cap	Aluminum Injection
Diğer Özellik		Other	
Lens		Lens	
Reflektör		Reflector	
Difüzör	Pleksi	Diffuser	Plexy
SDCM (MacAdam)	3	SDCM (MacAdam)	3
Renk Sıcaklığı	2700K/3000K/4000K	Colour Temperature	2700K/3000K/4000K
Ömür	50000h	Life Time	50000h
Çalışma Sıcaklığı	25°C	Operating Temperature	25°C
LED	Osram/Tridonic/Nichia Samsung/Cree	LED	Osram/Tridonic/Nichia Samsung/Cree
Sürücü	Osram/Tridonic	Driver	Osram/Tridonic
Uygunluk	EN 60598-1 EN 60598-2-1	Conformity	EN 60598-1 EN 60598-2-1

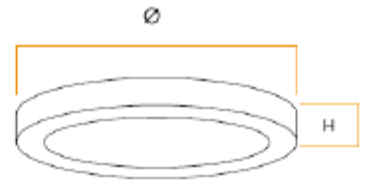

Ürün Kodu Product Code	Güç Power	Çıkış Işık Akısı Lumen Output	Verimlilik Efficiency	Işık Açısı Beam Angle	Işık Kaynağı Light Source	CRI	Ø (mm)	W (mm)	H (mm)
31051	45,5W	4275Lm	94m/W	120°	LED	80	600	100	110
31052	65W	5850Lm	90Lm/W	120°	LED	80	900	100	110
31053	71,5W	6390Lm	89Lm/W	120°	LED	80	1000	100	110
31054	84,5W	7560Lm	89Lm/W	120°	LED	80	1200	100	110
31055	100W	8900Lm	89Lm/W	120°	LED	80	1500	100	110
31056	207W	18423Lm	89Lm/W	120°	LED	80	3000	100	110
31057				120°	LED	80	∞	100	110



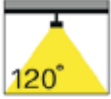

ÜRÜN ÖZELLİKLERİ/PRODUCT SPECIFICATIONS

Ürün Tanımı	Sıva Üstü Yüzük Lineer Armatür	Product Descripton	Surface Mounted Ring Lineer Luminaire
Gövde	Alüminyum Ekstrüzyon Profil	Body	Aluminum Extrusion Profile
Boya / Kapak	Alüminyum Enjeksiyon	Paint / Cap	Aluminum Injection
Diğer Özellik		Other	
Lens		Lens	
Reflektör		Reflector	
Difüzör	Pleksi	Diffuser	Plexy
SDCM (MacAdam)	3	SDCM (MacAdam)	3
Renk Sıcaklığı	2700K/3000K/4000K	Colour Temperature	2700K/3000K/4000K
Ömür	50000h	Life Time	50000h
Çalışma Sıcaklığı	25°C	Operating Temperature	25°C
LED	Osram/Tridonic/Nichia Samsung/Cree	LED	Osram/Tridonic/Nichia Samsung/Cree
Sürücü		Driver	
Uygunluk	EN 60598-1 EN 60598-2-1	Conformity	EN 60598-1 EN 60598-2-1

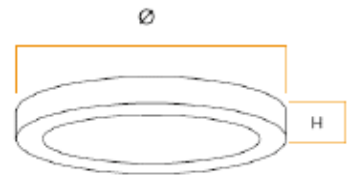

Ürün Kodu Product Code	Güç Power	Çıkış Işık Akısı Lumen Output	Verimlilik Efficiency	Işık Açısı Beam Angle	Işık Kaynağı Light Source	CRI	Ø (mm)	W (mm)	H (mm)
31340	45,5W	4275Lm	94m/W	120°	LED	80	600	100	150
31341	65W	5850Lm	90Lm/W	120°	LED	80	900	100	150
31342	71,5W	6390Lm	89Lm/W	120°	LED	80	1000	100	150
31343	84,5W	7560Lm	89Lm/W	120°	LED	80	1200	100	150
31344	100W	8900Lm	89Lm/W	120°	LED	80	1500	100	150
31345	120W	10680Lm	89Lm/W	120°	LED	80	1800	100	150
31346	207W	18423Lm	89Lm/W	120°	LED	80	3000	100	150



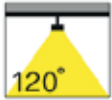

ÜRÜN ÖZELLİKLERİ/PRODUCT SPECIFICATIONS

ÜRÜN Tanımı	Sıva Üstü Yüzük Lineer Armatür	Product Descripton	Surface Mounted Ring Lineer Luminaire
Gövde	Alüminyum Ekstrüzyon Profil	Body	Aluminum Extrusion Profile
Boya / Kapak	Alüminyum Enjeksiyon	Paint / Cap	Aluminum Injection
Diğer Özellik		Other	
Lens		Lens	
Reflektör		Reflector	
Difüzör	Pleksi	Diffuser	Plexy
SDCM (MacAdam)	3	SDCM (MacAdam)	3
Renk Sıcaklığı	2700K/3000K/4000K	Colour Temperature	2700K/3000K/4000K
Ömür	50000h	Life Time	50000h
Çalışma Sıcaklığı	25°C	Operating Temperature	25°C
LED	Osram/Tridonic/Nichia Samsung/Cree	LED	Osram/Tridonic/Nichia Samsung/Cree
Sürücü		Driver	
Uygunluk	EN 60598-1 EN 60598-2-1	Conformity	EN 60598-1 EN 60598-2-1

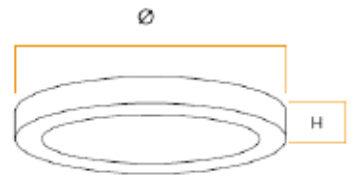

Ürün Kodu Product Code	Güç Power	Çıkış Işık Akısı Lumen Output	Verimlilik Efficiency	Işık Açısı Beam Angle	Işık Kaynağı Light Source	CRI	Ø (mm)	W (mm)	H (mm)
31058	45,5W	4275Lm	94m/W	120°	LED	80	600	100	200
31059	65W	5850Lm	90Lm/W	120°	LED	80	900	100	200
31060	71,5W	6390Lm	89Lm/W	120°	LED	80	1000	100	200
31061	84,5W	7560Lm	89Lm/W	120°	LED	80	1200	100	200
31062	100W	8900Lm	89Lm/W	120°	LED	80	1500	100	200
31063	207W	18423Lm	89Lm/W	120°	LED	80	3000	100	200
31064				120°	LED	80	∞	100	200

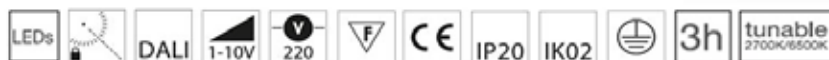

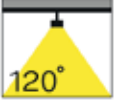

ÜRÜN ÖZELLİKLERİ/PRODUCT SPECIFICATIONS

Ürün Tanımı	Sıva Üstü Yüzük Lineer Armatür	Product Descripton	Surface Mounted Ring Lineer Luminaire
Gövde	Alüminyum Ekstrüzyon Profil	Body	Aluminum Extrusion Profile
Boya / Kapak	Alüminyum Enjeksiyon	Paint / Cap	Aluminum Injection
Diğer Özellik		Other	
Lens		Lens	
Reflektör		Reflector	
Difüzör	Pleksi	Diffuser	Plexy
SDCM (MacAdam)	3	SDCM (MacAdam)	3
Renk Sıcaklığı	2700K/3000K/4000K	Colour Temperature	2700K/3000K/4000K
Ömür	50000h	Life Time	50000h
Çalışma Sıcaklığı	25°C	Operating Temperature	25°C
LED	Osram/Tridonic/Nichia Samsung/Cree	LED	Osram/Tridonic/Nichia Samsung/Cree
Sürücü		Driver	
Uygunluk	EN 60598-1 EN 60598-2-1	Conformity	EN 60598-1 EN 60598-2-1

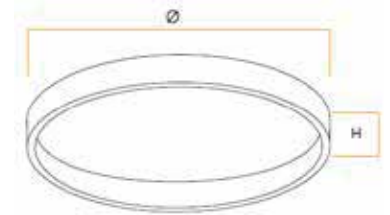

Ürün Kodu Product Code	Güç Power	Çıkış Işık Akısı Lumen Output	Verimlilik Efficiency	Işık Açısı Beam Angle	Işık Kaynağı Light Source	CRI	Ø (mm)	H (mm)
32026	68W	6120Lm	90Lm/W	120°	LED	80	600	62
32027	90W	8100Lm	90Lm/W	120°	LED	80	800	62
32028	113W	10170Lm	90Lm/W	120°	LED	80	1000	62
32029	135W	12156Lm	90Lm/W	120°	LED	80	1200	62
32030	226W	20340Lm	90Lm/W	120°	LED	80	2000	62
32031	565W	50850Lm	90Lm/W	120°	LED	80	5000	62
32032				120°	LED	80	∞	62



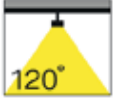
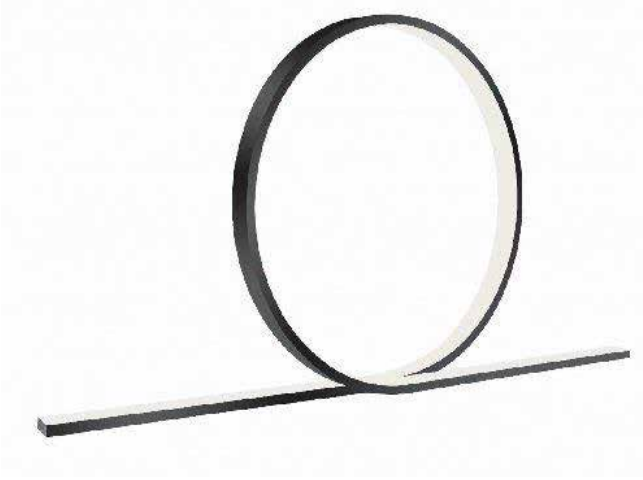

ÜRÜN ÖZELLİKLERİ/PRODUCT SPECIFICATIONS

Ürün Tanımı	Sıva Üstü Yüzük Lineer Armatür	Product Description	Surface Mounted Ring Linear Luminaire
Gövde	Alüminyum Ekstrüzyon Profil	Body	Aluminum Extrusion Profile
Boya / Kapak	Alüminyum Enjeksiyon	Paint / Cap	Aluminum Injection
Diğer Özellik		Other	
Lens		Lens	
Reflektör		Reflector	
Difüzör	Pleksi	Diffuser	Plexy
SDCM (MacAdam)	3	SDCM (MacAdam)	3
Renk Sıcaklığı	2700K/3000K/4000K	Colour Temperature	2700K/3000K/4000K
Ömür	50000h	Life Time	50000h
Çalışma Sıcaklığı	25°C	Operating Temperature	25°C
LED	Osram/Tridonic/Nichia Samsung/Cree	LED	Osram/Tridonic/Nichia Samsung/Cree
Sürücü		Driver	
Uygunluk	EN 60598-1 EN 60598-2-1	Conformity	EN 60598-1 EN 60598-2-1

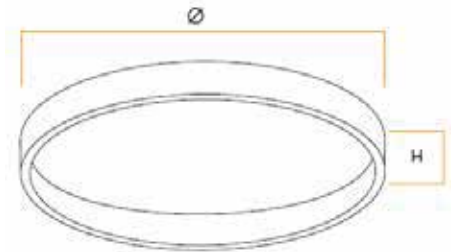

Ürün Kodu Product Code	Güç Power	Çıkış Işık Akısı Lumen Output	Verimlilik Efficiency	Işık Açısı Beam Angle	Işık Kaynağı Light Source	CRI	Ø (mm)	L (mm)	H (mm)
31305	68W	6120Lm	90Lm/W	120°	LED	80	600	1000/3000	62
31306	90W	8100Lm	90Lm/W	120°	LED	80	800	1000/3000	62
31307	113W	10170Lm	90Lm/W	120°	LED	80	1000	1000/3000	62
31308	135W	12156Lm	90Lm/W	120°	LED	80	1200	1000/3000	62
31309				120°	LED	80	∞	1000/3000	62



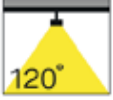

ÜRÜN ÖZELLİKLERİ/PRODUCT SPECIFICATIONS

Ürün Tanımı	Sıva Üstü Lineer Armatür	Product Description	Surface Mounted Lineer Luminaire
Gövde	Alüminyum Ekstrüzyon Profil	Body	Aluminum Extrusion Profile
Boya / Kapak	Alüminyum Enjeksiyon	Paint / Cap	Aluminum Injection
Diğer Özellik		Other	
Lens		Lens	
Reflektör		Reflector	
Difüzör	Pleksi	Diffuser	Plexy
SDCM (MacAdam)	3	SDCM (MacAdam)	3
Renk Sıcaklığı	2700K/3000K/4000K	Colour Temperature	2700K/3000K/4000K
Ömür	50000h	Life Time	50000h
Çalışma Sıcaklığı	25°C	Operating Temperature	25°C
LED	Osram/Tridonic/Nichia Samsung/Cree	LED	Osram/Tridonic/Nichia Samsung/Cree
Sürücü		Driver	
Uygunluk	EN 60598-1 EN 60598-2-1	Conformity	EN 60598-1 EN 60598-2-1



Ürün Kodu Product Code	Güç Power	Çıkış Işık Akısı Lumen Output	Verimlilik Efficiency	Işık Açısı Beam Angle	Işık Kaynağı Light Source	CRI	Ø (mm)	H (mm)
31165	91W	8190Lm	90Lm/W	120°	LED	80	600	77
31166	130W	12350Lm	90Lm/W	120°	LED	80	800	77
31167	344,5W	32680Lm	90Lm/W	120°	LED	80	1200	77
31168	91W	8190Lm	90Lm/W	120°	LED	80	600	95
31169	130W	12350Lm	90Lm/W	120°	LED	80	800	95
31170	344,5W	32680Lm	90Lm/W	120°	LED	80	1200	95

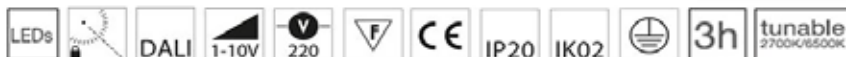

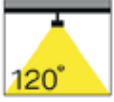
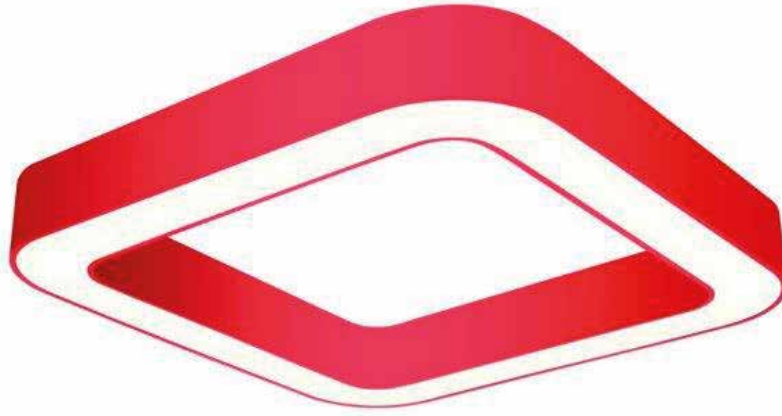

ÜRÜN ÖZELLİKLERİ/PRODUCT SPECIFICATIONS

Ürün Tanımı	Siva Üstü Kare Lineer Armatür	Product Description	Surface Mounted Square Linear Luminaire
Gövde	Alüminyum Ekstrüzyon Profil	Body	Aluminum Extrusion Profile
Boya / Kapak	Alüminyum Enjeksiyon	Paint / Cap	Aluminum Injection
Diğer Özellik		Other	
Lens		Lens	
Reflektör		Reflector	
Difüzör	Pleksi	Diffuser	Plexy
SDCM (MacAdam)	3	SDCM (MacAdam)	3
Renk Sıcaklığı	2700K/3000K/4000K	Colour Temperature	2700K/3000K/4000K
Ömür	50000h	Life Time	50000h
Çalışma Sıcaklığı	25°C	Operating Temperature	25°C
LED	Osram/Tridonic/Nichia Samsung/Cree	LED	Osram/Tridonic/Nichia Samsung/Cree
Sürücü		Driver	
Uygunluk	EN 60598-1 EN 60598-2-1	Conformity	EN 60598-1 EN 60598-2-1

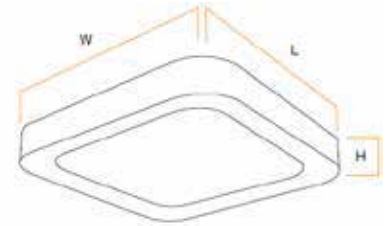

Ürün Kodu Product Code	Güç Power	Çıkış Işık Akısı Lumen Output	Verimlilik Efficiency	Işık Açısı Beam Angle	Işık Kaynağı Light Source	CRI	L (mm)	W (mm)	H (mm)
32039	52W	4680Lm	90Lm/W	120°	LED	80	600	600	77
32040	104W	9360Lm	90Lm/W	120°	LED	80	1200	1200	77
32041			90Lm/W	120°	LED	80	∞	∞	77



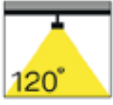

ÜRÜN ÖZELLİKLERİ/PRODUCT SPECIFICATIONS

Ürün Tanımı	Sıva Üstü Kare Lineer Armatür
Gövde	Alüminyum Ekstrüzyon Profil
Boya / Kapak	Alüminyum Enjeksiyon
Diğer Özellik	
Lens	
Reflektör	
Difüzör	Pleksi
SDCM (MacAdam)	3
Renk Sıcaklığı	2700K/3000K/4000K
Ömür	50000h
Çalışma Sıcaklığı	25°C
LED	Osram/Tridonic/Nichia Samsung/Cree
Sürücü	
Uygunluk	EN 60598-1 EN 60598-2-1

Product Description	Surface Mounted Square Linear Luminaire
Body	Aluminum Extrusion Profile
Paint / Cap	Aluminum Injection
Other	
Lens	
Reflector	
Diffuser	Plexy
SDCM (MacAdam)	3
Colour Temperature	2700K/3000K/4000K
Life Time	50000h
Operating Temperature	25°C
LED	Osram/Tridonic/Nichia Samsung/Cree
Driver	
Conformity	EN 60598-1 EN 60598-2-1

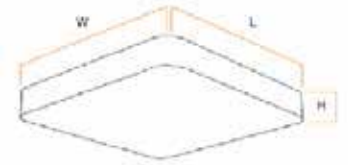

Ürün Kodu Product Code	Güç Power	Çıkış Işık Akısı Lumen Output	Verimlilik Efficiency	Işık Açısı Beam Angle	Işık Kaynağı Light Source	CRI	L (mm)	W (mm)	H (mm)
32033	39,6W	3960Lm	100Lm/W	120°	LED	80	600	600	77
32034	39,6W	4560Lm	115Lm/W	120°	LED	80	1200	300	77
32035				120°	LED	80	∞	∞	77
32036	39,6W	4560Lm	115Lm/W	120°	LED	80	600	600	95
32037	39,6W	4560Lm	115Lm/W	120°	LED	80	1200	300	95
32038				120°	LED	80	∞	∞	95



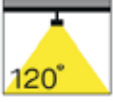

ÜRÜN ÖZELLİKLERİ/PRODUCT SPECIFICATIONS

Ürün Tanımı	Sıva Üstü Kare Lineer Armatür
Gövde	Alüminyum Ekstrüzyon Profil
Boya / Kapak	Alüminyum Enjeksiyon
Diğer Özellik	
Lens	
Reflektör	
Difüzör	Pleksi
SDCM (MacAdam)	3
Renk Sıcaklığı	2700K/3000K/4000K
Ömür	50000h
Çalışma Sıcaklığı	25°C
LED	Osram/Tridonic/Nichia Samsung/Cree
Sürücü	
Uygunluk	EN 60598-1 EN 60598-2-1

Product Descripton	Surface Mounted Square Linear Luminaire
Body	Aluminum Extrusion Profile
Paint / Cap	Aluminum Injection
Other	
Lens	
Reflector	
Diffuser	Plexy
SDCM (MacAdam)	3
Colour Temperature	2700K/3000K/4000K
Life Time	50000h
Operating Temperature	25°C
LED	Osram/Tridonic/Nichia Samsung/Cree
Driver	
Conformity	EN 60598-1 EN 60598-2-1



Ürün Kodu Product Code	Güç Power	Çıkış Işık Akısı Lumen Output	Verimlilik Efficiency	Işık Açısı Beam Angle	Işık Kaynağı Light Source	CRI	L (mm)	W (mm)	H (mm)
31301	52W	4160Lm	80Lm/W	120°	LED	80	600	600	70
31302	85W	7605Lm	90Lm/W	120°	LED	80	600	1200	70
31303	∞w	∞Lm	90Lm/W	120°	LED	80	∞	∞	70



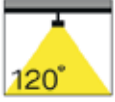

ÜRÜN ÖZELLİKLERİ/PRODUCT SPECIFICATIONS

Ürün Tanımı	Sıva Üstü Lineer Armatür	Product Description	Surface Mounted Linear Luminaire
Gövde	Alüminyum Ekstrüzyon Profil	Body	Aluminum Extrusion Profile
Boya / Kapak	Alüminyum Enjeksiyon	Paint / Cap	Aluminum Injection
Diğer Özellik		Other	
Lens		Lens	
Reflektör		Reflector	
Difüzör	Pleksi	Diffuser	Plexy
SDCM (MacAdam)	3	SDCM (MacAdam)	3
Renk Sıcaklığı	2700K/3000K/4000K	Colour Temperature	2700K/3000K/4000K
Ömür	50000h	Life Time	50000h
Çalışma Sıcaklığı	25°C	Operating Temperature	25°C
LED	Osram/Tridonic/Nichia Samsung/Cree	LED	Osram/Tridonic/Nichia Samsung/Cree
Sürücü		Driver	
Uygunluk	EN 60598-1 EN 60598-2-1	Conformity	EN 60598-1 EN 60598-2-1



Ürün Kodu Product Code	Güç Power	Çıkış Işık Akısı Lumen Output	Verimlilik Efficiency	Işık Açısı Beam Angle	Işık Kaynağı Light Source	CRI	L (mm)	W (mm)	H (mm)
31111	30W	2700Lm	85Lm/W	120°	LED	80	1000	62	20
31112	36W	3240Lm	85Lm/W	120°	LED	80	1200	62	20
31113	45W	4050Lm	85Lm/W	120°	LED	80	1500	62	20
31114	60W	5400Lm	85Lm/W	120°	LED	80	2000	62	20
31115	90W	8100Lm	85Lm/W	120°	LED	80	3000	62	20
31116	30W/m	2700Lm/m	85Lm/W	120°	LED	80	∞	62	20

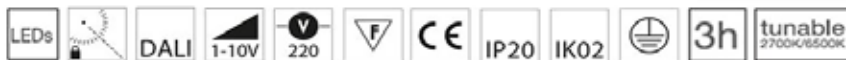

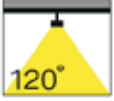
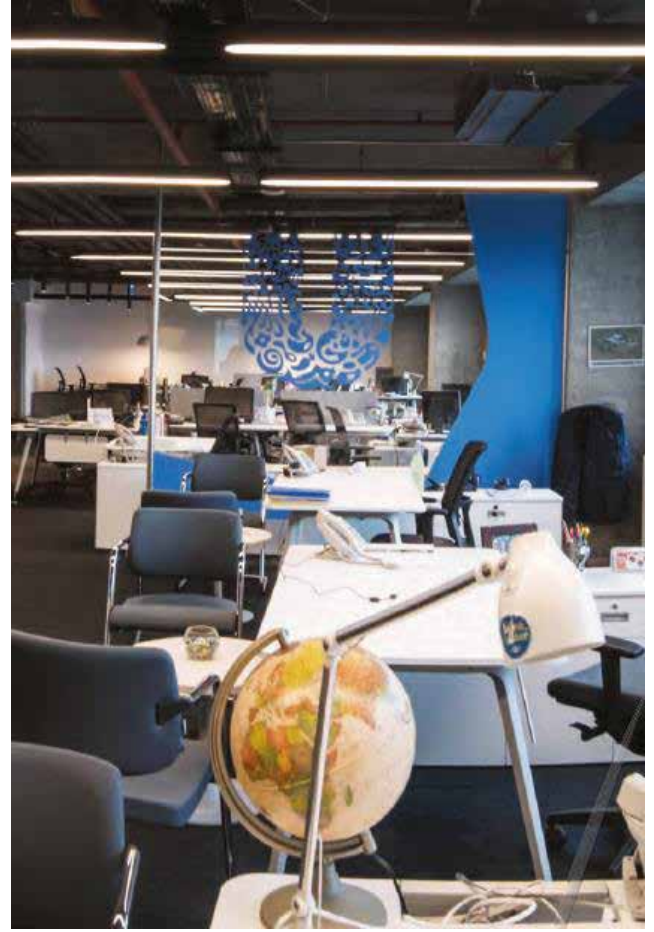

ÜRÜN ÖZELLİKLERİ/PRODUCT SPECIFICATIONS

Ürün Tanımı	Sıva Üstü Lineer Armatür	Product Description	Surface Mounted Lineer Luminaire
Gövde	Alüminyum Ekstrüzyon Profil	Body	Aluminum Extrusion Profile
Boya / Kapak	Alüminyum Enjeksiyon	Paint / Cap	Aluminum Injection
Diğer Özellik		Other	
Lens		Lens	
Reflektör		Reflector	
Difüzör	Pleksi	Diffuser	Plexy
SDCM (MacAdam)	3	SDCM (MacAdam)	3
Renk Sıcaklığı	2700K/3000K/4000K	Colour Temperature	2700K/3000K/4000K
Ömür	50000h	Life Time	50000h
Çalışma Sıcaklığı	25°C	Operating Temperature	25°C
LED	Osram/Tridonic/Nichia Samsung/Cree	LED	Osram/Tridonic/Nichia Samsung/Cree
Sürücü		Driver	
Uygunluk	EN 60598-1 EN 60598-2-1	Conformity	EN 60598-1 EN 60598-2-1

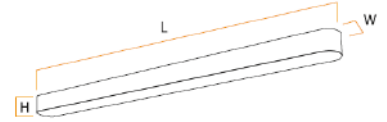

Ürün Kodu Product Code	Güç Power	Çıkış Işık Akısı Lumen Output	Verimlilik Efficiency	Işık Açısı Beam Angle	Işık Kaynağı Light Source	CRI	L (mm)	W (mm)	H (mm)
31226	26W	2340Lm	90Lm/W	120°	LED	80	1000	100	77
31227	31,2W	2808Lm	90Lm/W	120°	LED	80	1200	100	77
31228	39W	3510Lm	90Lm/W	120°	LED	80	1500	100	77
31229	52W	4680Lm	90Lm/W	120°	LED	80	2000	100	77
31230	78W	7020Lm	90Lm/W	120°	LED	80	3000	100	77
31231	26W/m	2340Lm/m	90Lm/W	120°	LED	80	∞	100	77

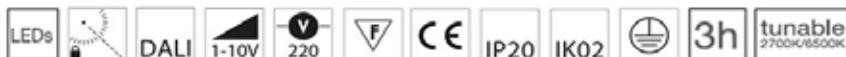

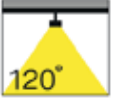
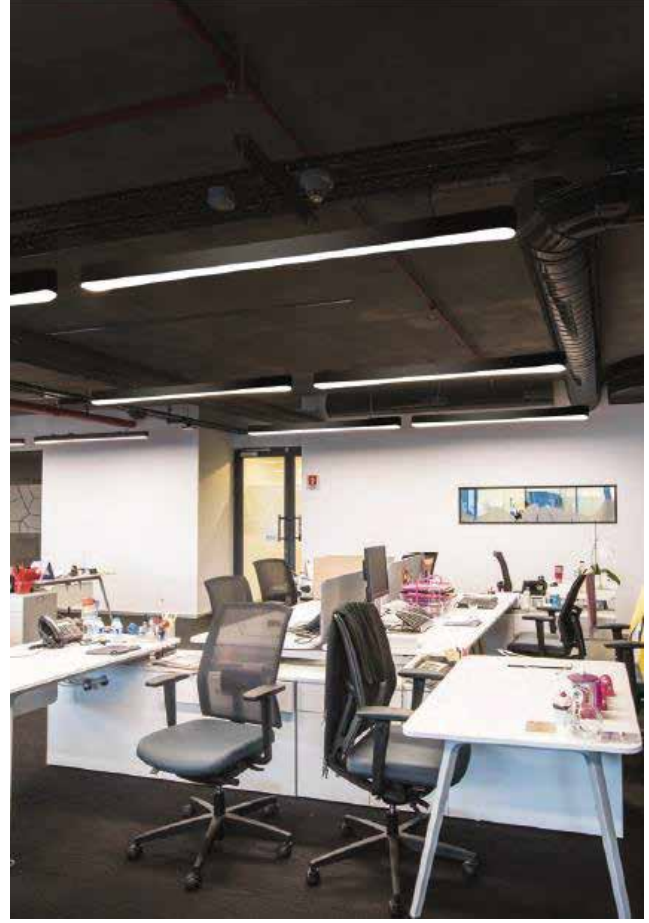
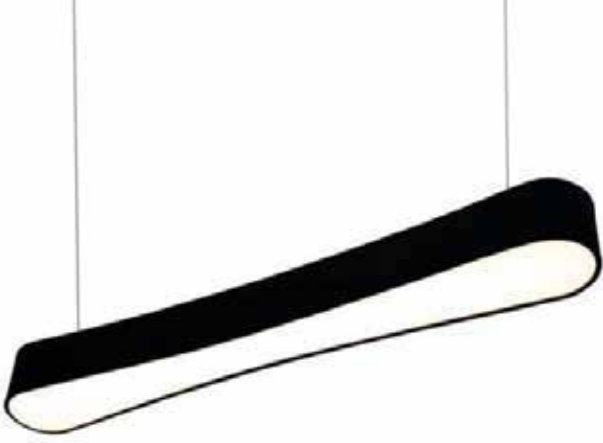

ÜRÜN ÖZELLİKLERİ/PRODUCT SPECIFICATIONS

Ürün Tanımı	Sıva Üstü Lineer Armatür	Product Description	Surface Mounted Lineer Luminaire
Gövde	Alüminyum Ekstrüzyon Profil	Body	Aluminum Extrusion Profile
Boya / Kapak	Alüminyum Enjeksiyon	Paint / Cap	Aluminum Injection
Diğer Özellik		Other	
Lens		Lens	
Reflektör		Reflector	
Difüzör	Pleksi	Diffuser	Plexy
SDCM (MacAdam)	3	SDCM (MacAdam)	3
Renk Sıcaklığı	2700K/3000K/4000K	Colour Temperature	2700K/3000K/4000K
Ömür	50000h	Life Time	50000h
Çalışma Sıcaklığı	25°C	Operating Temperature	25°C
LED	Osram/Tridonic/Nichia Samsung/Cree	LED	Osram/Tridonic/Nichia Samsung/Cree
Sürücü		Driver	
Uygunluk	EN 60598-1 EN 60598-2-1	Conformity	EN 60598-1 EN 60598-2-1

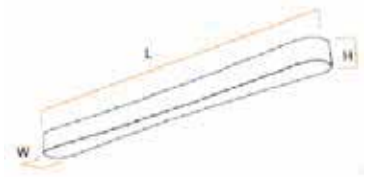

Ürün Kodu Product Code	Güç Power	Çıkış Işık Akısı Lumen Output	Verimlilik Efficiency	Işık Açısı Beam Angle	Işık Kaynağı Light Source	CRI	L (mm)	W (mm)	H (mm)
31212	26W	2340Lm	90Lm/W	120°	LED	80	1000	120	77
31213	31,2W	2808Lm	90Lm/W	120°	LED	80	1200	120	77
31214	39W	3510Lm	90Lm/W	120°	LED	80	1500	120	77
31215	52W	4680Lm	90Lm/W	120°	LED	80	2000	120	77
31216	78W	7020Lm	90Lm/W	120°	LED	80	3000	120	77
31217	26W/m	2340Lm/m	90Lm/W	120°	LED	80	∞	120	77



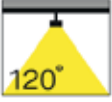

ÜRÜN ÖZELLİKLERİ/PRODUCT SPECIFICATIONS

Ürün Tanımı	Sarkıt Linear Armatür	Product Description	Surface Mounted Lineer Luminaire
Gövde	Alüminyum Ekstrüzyon Profil	Body	Aluminum Extrusion Profile
Boya / Kapak	Alüminyum Enjeksiyon	Paint / Cap	Aluminum Injection
Diğer Özellik		Other	
Lens		Lens	
Reflektör		Reflector	
Difüzör	Pleksi	Diffuser	Plexy
SDCM (MacAdam)	3	SDCM (MacAdam)	3
Renk Sıcaklığı	2700K/3000K/4000K	Colour Temperature	2700K/3000K/4000K
Ömür	50000h	Life Time	50000h
Çalışma Sıcaklığı	25°C	Operating Temperature	25°C
LED	Osram/Tridonic/Nichia Samsung/Cree	LED	Osram/Tridonic/Nichia Samsung/Cree
Sürücü		Driver	
Uygunluk	EN 60598-1 EN 60598-2-1	Conformity	EN 60598-1 EN 60598-2-1



Ürün Kodu Product Code	Güç Power	Çıkış Işık Akısı Lumen Output	Verimlilik Efficiency	Işık Açısı Beam Angle	Işık Kaynağı Light Source	CRI	L (mm)	W (mm)	H (mm)
31141	52W	4660Lm	90Lm/W	120°	LED	80	1000	180	50
31142	62,4W	5592Lm	90Lm/W	120°	LED	80	1200	180	50
31143	78W	7020Lm	90Lm/W	120°	LED	80	1500	180	50
31144	104W	9360Lm	90Lm/W	120°	LED	80	2000	180	50
31145	156W	13980Lm	90Lm/W	120°	LED	80	3000	180	50
31146	52W/m	4660Lm/m	90Lm/W	120°	LED	80	∞	180	50

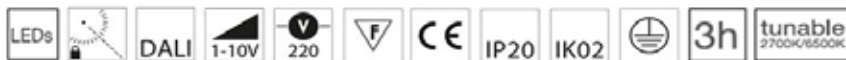

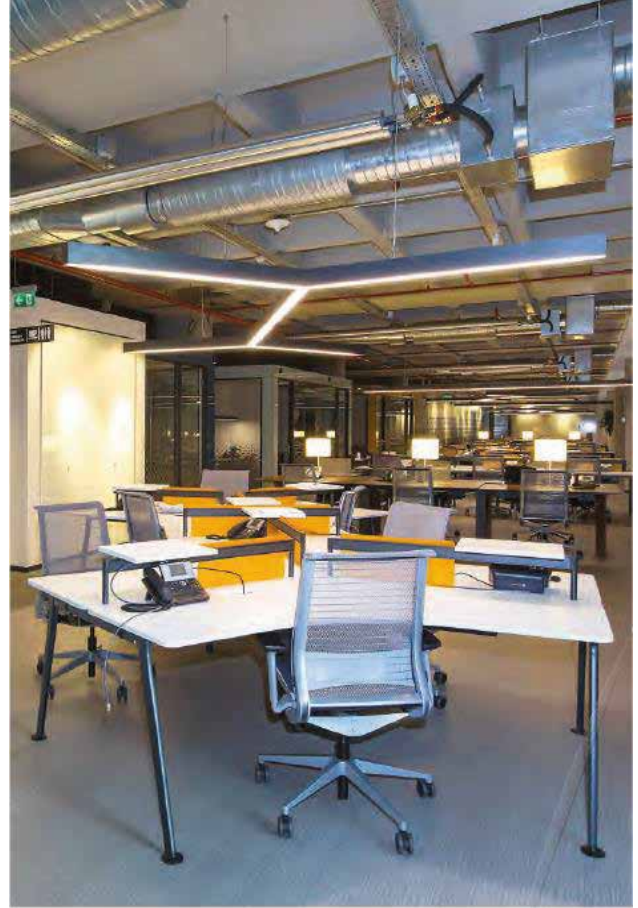

ÜRÜN ÖZELLİKLERİ/PRODUCT SPECIFICATIONS

Ürün Tanımı	Sıva Üstü Lineer Armatür	Product Descripton	Surface Mounted Lineer Luminaire
Gövde	Alüminyum Ekstrüzyon Profil	Body	Aluminum Extrusion Profile
Boya / Kapak	Alüminyum Enjeksiyon	Paint / Cap	Aluminum Injection
Diğer Özellik		Other	
Lens		Lens	
Reflektör		Reflector	
Difüzör	Pleksi	Diffuser	Plexy
SDCM (MacAdam)	3	SDCM (MacAdam)	3
Renk Sıcaklığı	2700K/3000K/4000K	Colour Temperature	2700K/3000K/4000K
Ömür	50000h	Life Time	50000h
Çalışma Sıcaklığı	25°C	Operating Temperature	25°C
LED	Osram/Tridonic/Nichia Samsung/Cree	LED	Osram/Tridonic/Nichia Samsung/Cree
Sürücü		Driver	
Uygunluk	EN 60598-1 EN 60598-2-1	Conformity	EN 60598-1 EN 60598-2-1

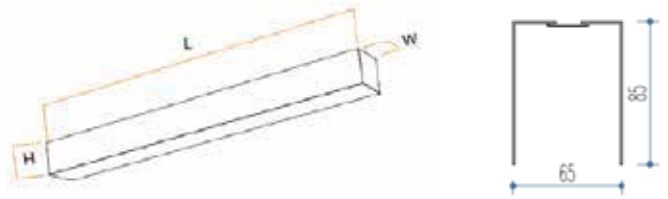

Ürün Kodu Product Code	Güç Power	Çıkış Işık Akısı Lumen Output	Verimlilik Efficiency	Işık Açısı Beam Angle	Işık Kaynağı Light Source	CRI	L (mm)	W (mm)	H (mm)
31017	26W	2080Lm	80Lm/W	120°	LED	80	1000	65	85
31018	31,2W	2496Lm	80Lm/W	120°	LED	80	1200	65	85
31019	39W	3120Lm	80Lm/W	120°	LED	80	1500	65	85
31021	52W	4160Lm	80Lm/W	120°	LED	80	2000	65	85
31024	78W	6240Lm	80Lm/W	120°	LED	80	3000	65	85
31020	26W/m	2080Lm/m	80Lm/W	120°	LED	80	∞	65	85





ÜRÜN ÖZELLİKLERİ/PRODUCT SPECIFICATIONS

Ürün Tanımı	Sıva Üstü Lineer Armatür	Product Descripton	Surface Mounted Lineer Luminaire
Gövde	Alüminyum Ekstrüzyon Profil	Body	Aluminum Extrusion Profile
Boya / Kapak	Alüminyum Enjeksiyon	Paint / Cap	Aluminum Injection
Diğer Özellik		Other	
Lens		Lens	
Reflektör		Reflector	
Difüzör	Pleksi	Difuser	Plexy
SDCM (MacAdam)	3	SDCM (MacAdam)	3
Renk Sıcaklığı	2700K/3000K/4000K	Colour Temperature	2700K/3000K/4000K
Ömür	50000h	Life Time	50000h
Çalışma Sıcaklığı	25°C	Operating Temperature	25°C
LED	Osram/Tridonic/Nichia Samsung/Cree	LED	Osram/Tridonic/Nichia Samsung/Cree
Sürücü		Driver	
Uygunluk	EN 60598-1 EN 60598-2-1	Conformity	EN 60598-1 EN 60598-2-1



Ürün Kodu Product Code	Güç Power	Çıkış Işık Akısı Lumen Output	Verimlilik Efficiency	Işık Açısı Beam Angle	Işık Kaynağı Light Source	CRI	L (mm)	W (mm)	H (mm)
31153	26W	2600Lm	100Lm/W	120°	LED	80	1000	84	70
31154	31,2W	3120Lm	100Lm/W	120°	LED	80	1200	84	70
31155	39W	3900Lm	100Lm/W	120°	LED	80	1500	84	70
31156	52W	5200Lm	100Lm/W	120°	LED	80	2000	84	70
31157	78W	7800Lm	100Lm/W	120°	LED	80	3000	84	70
31158	26W/m	2600Lm/m	100Lm/W	120°	LED	80	∞	84	70



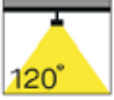

ÜRÜN ÖZELLİKLERİ/PRODUCT SPECIFICATIONS

Ürün Tanımı	Siva Üstü Lineer Armatür	Product Description	Surface Mounted Lineer Luminaire
Gövde	Alüminyum Ekstrüzyon Profil	Body	Aluminum Extrusion Profile
Boya / Kapak	Alüminyum Enjeksiyon	Paint / Cap	Aluminum Injection
Diğer Özellik		Other	
Lens		Lens	
Reflektör		Reflector	
Difüzör	Pleksi	Diffuser	Plexy
SDCM (MacAdam)	3	SDCM (MacAdam)	3
Renk Sıcaklığı	2700K/3000K/4000K	Colour Temperature	2700K/3000K/4000K
Ömür	50000h	Life Time	50000h
Çalışma Sıcaklığı	25°C	Operating Temperature	25°C
LED	Osram/Tridonic/Nichia Samsung/Cree	LED	Osram/Tridonic/Nichia Samsung/Cree
Sürücü		Driver	
Uygunluk	EN 60598-1 EN 60598-2-1	Conformity	EN 60598-1 EN 60598-2-1

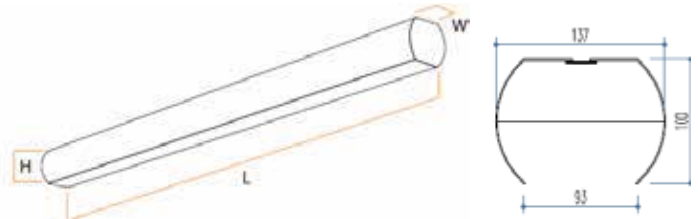

Ürün Kodu Product Code	Güç Power	Çıkış Işık Akısı Lumen Output	Verimlilik Efficiency	Işık Açısı Beam Angle	Işık Kaynağı Light Source	CRI	L (mm)	W (mm)	H (mm)
31159	26W	2600Lm	100Lm/W	120°	LED	80	1000	137	100
31160	31,2W	3120Lm	100Lm/W	120°	LED	80	1200	137	100
31161	39W	3900Lm	100Lm/W	120°	LED	80	1500	137	100
31162	52W	5200Lm	100Lm/W	120°	LED	80	2000	137	100
31163	78W	7800Lm	100Lm/W	120°	LED	80	3000	137	100
31164	26W/m	2600Lm/m	100Lm/W	120°	LED	80	∞	137	100

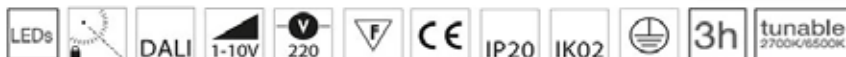

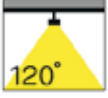

ÜRÜN ÖZELLİKLERİ/PRODUCT SPECIFICATIONS

Ürün Tanımı	Siva Üstü Yüzük Lineer Armatür	Product Descripton	Surface Mounted Ring Linear Luminaire
Gövde	Alüminyum Ekstrüzyon Profil	Body	Aluminum Extrusion Profile
Boya / Kapak	Alüminyum Enjeksiyon	Paint / Cap	Aluminum Injection
Diğer Özellik		Other	
Lens		Lens	
Reflektör		Reflector	
Difüzör	Plekxi	Difuser	Plexy
SDCM (MacAdam)	3	SDCM (MacAdam)	3
Renk Sıcaklığı	2700K/3000K/4000K	Colour Temperature	2700K/3000K/4000K
Ömür	50000h	Life Time	50000h
Çalışma Sıcaklığı	25°C	Operating Temperature	25°C
LED	Osram/Tridonic/Nichia Samsung/Cree	LED	Osram/Tridonic/Nichia Samsung/Cree
Sürücü		Driver	
Uygunluk	EN 60598-1 EN 60598-2-1	Conformity	EN 60598-1 EN 60598-2-1

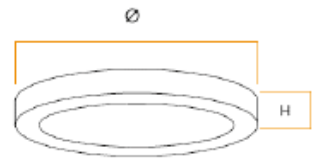

Ürün Kodu Product Code	Güç Power	Çıkış Işık Akısı Lumen Output	Verimlilik Efficiency	Işık Açısı Beam Angle	Işık Kaynağı Light Source	CRI	Ø (mm)	W (mm)	H (mm)
31044	45,5W	4275Lm	94m/W	120°	LED	80	600	100	95
31045	65W	5850Lm	90Lm/W	120°	LED	80	900	100	95
31046	71,5W	6390Lm	89Lm/W	120°	LED	80	1000	100	95
31047	84,5W	7560Lm	89Lm/W	120°	LED	80	1200	100	95
31048	100W	8900Lm	89Lm/W	120°	LED	80	1500	100	95
31049	207W	18423Lm	89Lm/W	120°	LED	80	3000	100	95
31050				120°	LED	80	∞	100	95



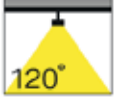

ÜRÜN ÖZELLİKLERİ/PRODUCT SPECIFICATIONS

Ürün Tanımı	Siva Üstü Lineer Armatür	Product Description	Surface Mounted Lineer Luminaire
Gövde	Alüminyum Ekstrüzyon Profil	Body	Aluminum Extrusion Profile
Boya / Kapak	Alüminyum Enjeksiyon	Paint / Cap	Aluminum Injection
Diğer Özellik		Other	
Lens		Lens	
Reflektör		Reflector	
Difüzör	Pleksi	Diffuser	Plexy
SDCM (MacAdam)	3	SDCM (MacAdam)	3
Renk Sıcaklığı	2700K/3000K/4000K	Colour Temperature	2700K/3000K/4000K
Ömür	50000h	Life Time	50000h
Çalışma Sıcaklığı	25°C	Operating Temperature	25°C
LED	Osram/Tridonic/Nichia Samsung/Cree	LED	Osram/Tridonic/Nichia Samsung/Cree
Sürücü		Driver	
Uygunluk	EN 60598-1 EN 60598-2-1	Conformity	EN 60598-1 EN 60598-2-1

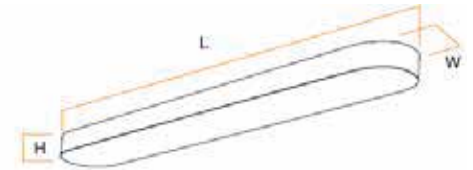

Ürün Kodu Product Code	Güç Power	Çıkış Işık Akısı Lumen Output	Verimlilik Efficiency	Işık Açısı Beam Angle	Işık Kaynağı Light Source	CRI	L (mm)	W (mm)	H (mm)
31238	78W	7800Lm	100Lm/W	120°	LED	80	1000	235	77
31239	93,6W	9360Lm	100Lm/W	120°	LED	80	1200	235	77
31240	117W	11700Lm	100Lm/W	120°	LED	80	1500	235	77
31241	156W	15600Lm	100Lm/W	120°	LED	80	2000	235	77
31242	234W	23400Lm	100Lm/W	120°	LED	80	3000	235	77
31243	78W/m	7800Lm/m	100Lm/W	120°	LED	80	∞	235	77



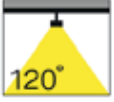

ÜRÜN ÖZELLİKLERİ/PRODUCT SPECIFICATIONS

Ürün Tanımı	Siva Üstü Lineer Armatür	Product Description	Surface Mounted Lin
Gövde	Alüminyum Ekstrüzyon Profil	Body	Aluminum Extrusion Profile
Boya / Kapak	Alüminyum Enjeksiyon	Paint / Cap	Aluminum Injection
Diğer Özellik		Other	
Lens		Lens	
Reflektör		Reflector	
Difüzör	Pleksi	Diffuser	Plexy
SDCM (MacAdam)	3	SDCM (MacAdam)	3
Renk Sıcaklığı	2700K/3000K/4000K	Colour Temperature	2700K/3000K/4000K
Ömür	50000h	Life Time	50000h
Çalışma Sıcaklığı	25°C	Operating Temperature	25°C
LED	Osram/Tridonic/Nichia Samsung/Cree	LED	Osram/Tridonic/Nichia Samsung/Cree
Sürücü		Driver	
Uygunluk	EN 60598-1 EN 60598-2-1	Conformity	EN 60598-1 EN 60598-2-1



Ürün Kodu Product Code	Güç Power	Çıkış Işık Akısı Lumen Output	Verimlilik Efficiency	Işık Açısı Beam Angle	Işık Kaynağı Light Source	CRI	L (mm)	W (mm)	H (mm)
31262	32,5W	3250Lm	100Lm/W	120°	LED	80	835	447	77
31263				120°	LED	80	∞	∞	77



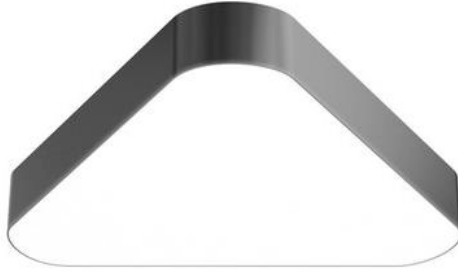
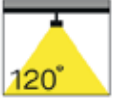

ÜRÜN ÖZELLİKLERİ/PRODUCT SPECIFICATIONS

Ürün Tanımı	Siva Üstü Lineer Armatür	Product Description	Surface Mounted Lineer Luminaire
Gövde	Alüminyum Ekstrüzyon Profil	Body	Aluminum Extrusion Profile
Boya / Kapak	Alüminyum Enjeksiyon	Paint / Cap	Aluminum Injection
Diğer Özellik		Other	
Lens		Lens	
Reflektör		Reflector	
Difüzör	Pleksi	Diffuser	Plexy
SDCM (MacAdam)	3	SDCM (MacAdam)	3
Renk Sıcaklığı	2700K/3000K/4000K	Colour Temperature	2700K/3000K/4000K
Ömür	50000h	Life Time	50000h
Çalışma Sıcaklığı	25°C	Operating Temperature	25°C
LED	Osram/Tridonic/Nichia Samsung/Cree	LED	Osram/Tridonic/Nichia Samsung/Cree
Sürücü		Driver	
Uygunluk	EN 60598-1 EN 60598-2-1	Conformity	EN 60598-1 EN 60598-2-1



Ürün Kodu Product Code	Güç Power	Çıkış Işık Akısı Lumen Output	Verimlilik Efficiency	Işık Açısı Beam Angle	Işık Kaynağı Light Source	CRI	L (mm)	W (mm)	H (mm)
31264	45,5W	4550Lm	100Lm/W	120°	LED	80	600	600	77
31265	156W	15600Lm	100Lm/W	120°	LED	80	1200	1200	77
31266	156W	15600Lm	100Lm/W	120°	LED	80	1200	1200	95
31267				120°	LED	80	∞	∞	77
31268				120°	LED	80	∞	∞	95

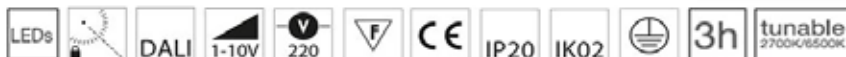

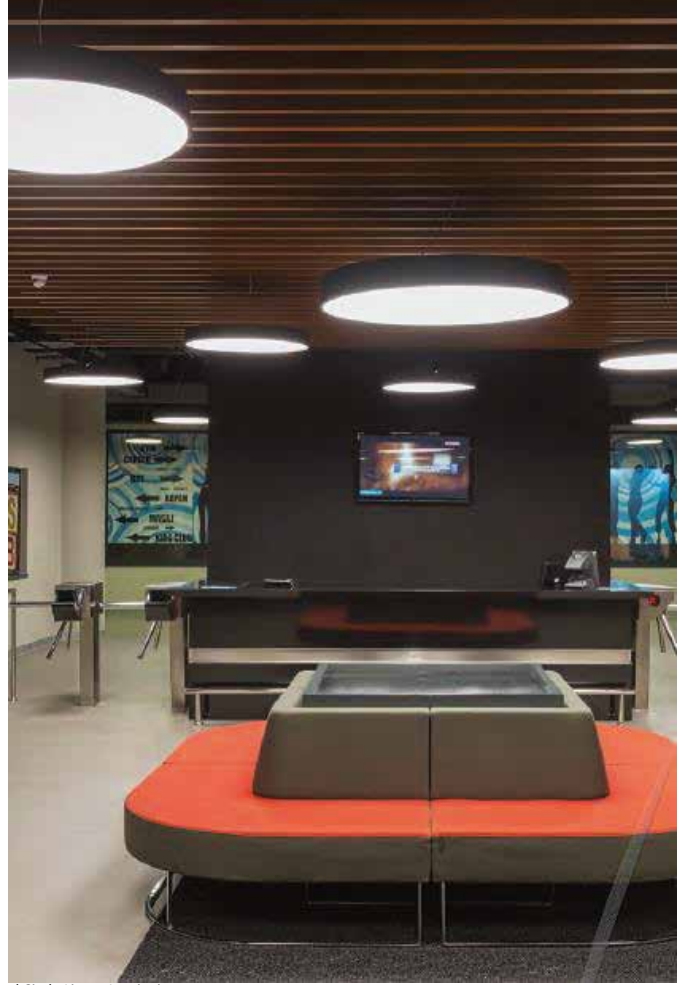

ÜRÜN ÖZELLİKLERİ/PRODUCT SPECIFICATIONS

Ürün Tanımı	Sıva Üstü Halka Lineer Armatür	Product Description	Surface Mounted Circle Linear Luminaire
Gövde	Alüminyum Ekstrüzyon Profil	Body	Aluminum Extrusion Profile
Boya / Kapak	Alüminyum Enjeksiyon	Paint / Cap	Aluminum Injection
Diğer Özellik		Other	
Lens		Lens	
Reflektör		Reflector	
Difüzör	Pleksi	Diffuser	Plexy
SDCM (MacAdam)	3	SDCM (MacAdam)	3
Renk Sıcaklığı	2700K/3000K/4000K	Colour Temperature	2700K/3000K/4000K
Ömür	50000h	Life Time	50000h
Çalışma Sıcaklığı	25°C	Operating Temperature	25°C
LED	Osram/Tridonic/Nichia Samsung/Cree	LED	Osram/Tridonic/Nichia Samsung/Cree
Sürücü		Driver	
Uygunluk	EN 60598-1 EN 60598-2-1	Conformity	EN 60598-1 EN 60598-2-1

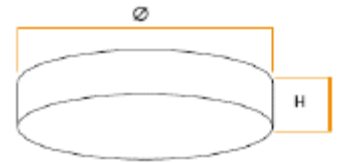

Ürün Kodu Product Code	Güç Power	Çıkış Işık Akısı Lumen Output	Verimlilik Efficiency	Işık Açısı Beam Angle	Işık Kaynağı Light Source	CRI	Ø (mm)	H (mm)
31177	26W	2600Lm	100Lm/W	120°	LED	80	300	77
31178	39W	3900Lm	100Lm/W	120°	LED	80	400	77
31179	39W	5000Lm	100Lm/W	120°	LED	80	500	77
31180	65W	6500Lm	100Lm/W	120°	LED	80	600	77
31181	143W	14300Lm	100Lm/W	120°	LED	80	800	77
31182	260W	26000Lm	100Lm/W	120°	LED	80	1000	77
31183			100Lm/W	120°	LED	80	∞	77
31184	26W	2600Lm	100Lm/W	120°	LED	80	300	95
31185	39W	3900Lm	100Lm/W	120°	LED	80	400	95
31186	39W	5000Lm	100Lm/W	120°	LED	80	500	95
31187	65W	6500Lm	100Lm/W	120°	LED	80	600	95
31188	143W	14300Lm	100Lm/W	120°	LED	80	800	95
31189	260W	26000Lm	100Lm/W	120°	LED	80	1000	95
31190			100Lm/W	120°	LED	80	∞	95



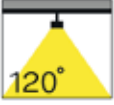
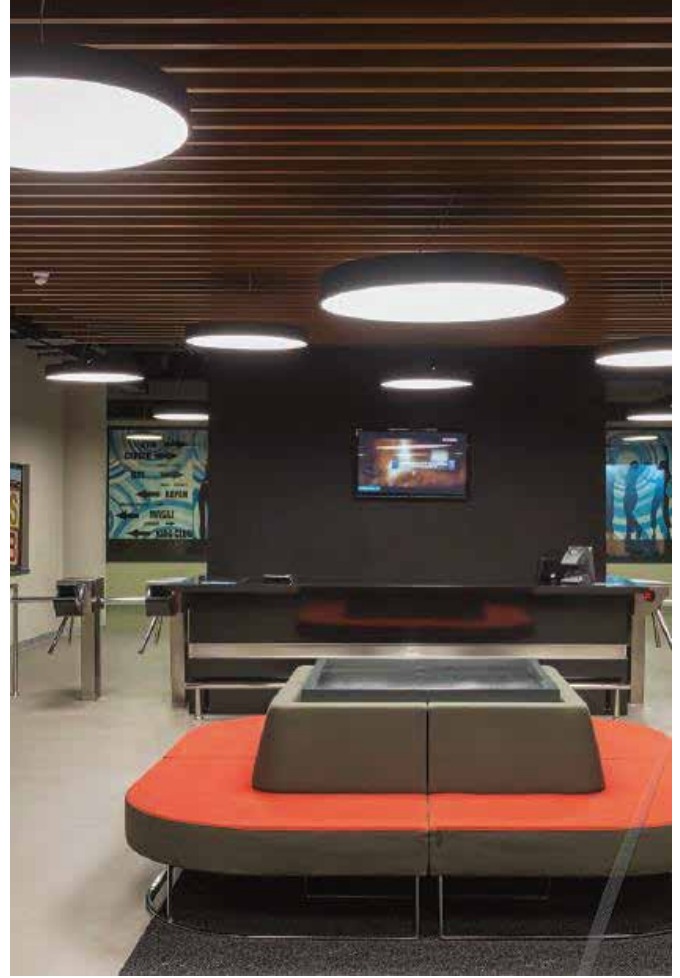
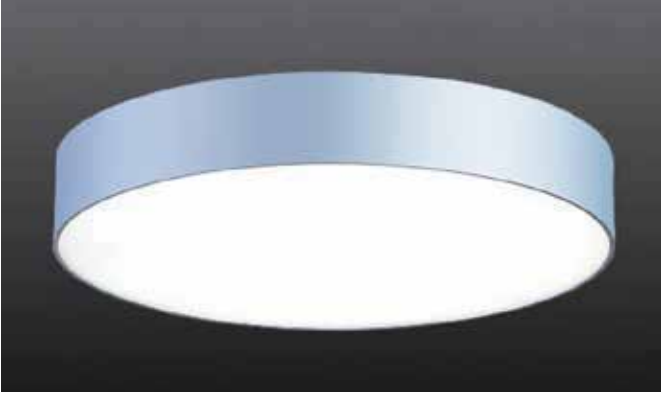

ÜRÜN ÖZELLİKLERİ/PRODUCT SPECIFICATIONS

Ürün Tanımı	Sıva Üstü Halka Lineer Armatür	Product Description	Surface Mounted Circle Lineer Luminaire
Gövde	Alüminyum Ekstrüzyon Profil	Body	Aluminum Extrusion Profile
Boya / Kapak	Alüminyum Enjeksiyon	Paint / Cap	Aluminum Injection
Diğer Özellik		Other	
Lens		Lens	
Reflektör		Reflector	
Difüzör	Pleksi	Diffuser	Plexy
SDCM (MacAdam)	3	SDCM (MacAdam)	3
Renk Sıcaklığı	2700K/3000K/4000K	Colour Temperature	2700K/3000K/4000K
Ömür	50000h	Life Time	50000h
Çalışma Sıcaklığı	25°C	Operating Temperature	25°C
LED	Osram/Tridonic/Nichia Samsung/Cree	LED	Osram/Tridonic/Nichia Samsung/Cree
Sürücü		Driver	
Uygunluk	EN 60598-1 EN 60598-2-1	Conformity	EN 60598-1 EN 60598-2-1



Ürün Kodu Product Code	Güç Power	Çıkış Işık Akısı Lumen Output	Verimlilik Efficiency	Işık Açısı Beam Angle	Işık Kaynağı Light Source	CRI	Ø (mm)	H (mm)
31191	26W	2600Lm	100Lm/W	120°	LED	80	300	110
31192	39W	3900Lm	100Lm/W	120°	LED	80	400	110
31193	39W	5000Lm	100Lm/W	120°	LED	80	500	110
31194	65W	6500Lm	100Lm/W	120°	LED	80	600	110
31195	143W	14300Lm	100Lm/W	120°	LED	80	800	110
31196	260W	26000Lm	100Lm/W	120°	LED	80	1000	110
31197			100Lm/W	120°	LED	80	∞	110
31198	26W	2600Lm	100Lm/W	120°	LED	80	300	200
31199	39W	3900Lm	100Lm/W	120°	LED	80	400	200
31200	39W	5000Lm	100Lm/W	120°	LED	80	500	200
31201	65W	6500Lm	100Lm/W	120°	LED	80	600	200
31202	143W	14300Lm	100Lm/W	120°	LED	80	800	200
31203	260W	26000Lm	100Lm/W	120°	LED	80	1000	200
31204			100Lm/W	120°	LED	80	∞	200



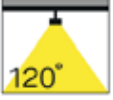

ÜRÜN ÖZELLİKLERİ/PRODUCT SPECIFICATIONS

Ürün Tanımı	Sıva Üstü Kare Lineer Armatür
Gövde	Alüminyum Ekstrüzyon Profil
Boya / Kapak	Alüminyum Enjeksiyon
Diğer Özellik	
Lens	
Reflektör	
Difüzör	Pleksi
SDCM (MacAdam)	3
Renk Sıcaklığı	2700K/3000K/4000K
Ömür	50000h
Çalışma Sıcaklığı	25°C
LED	Osram/Tridonic/Nichia Samsung/Cree
Sürücü	
Uygunluk	EN 60598-1 EN 60598-2-1

Product Description	Surface Mounted Square Linear Luminaire
Body	Aluminum Extrusion Profile
Paint / Cap	Aluminum Injection
Other	
Lens	
Reflector	
Diffuser	Plexy
SDCM (MacAdam)	3
Colour Temperature	2700K/3000K/4000K
Life Time	50000h
Operating Temperature	25°C
LED	Osram/Tridonic/Nichia Samsung/Cree
Driver	
Conformity	EN 60598-1 EN 60598-2-1

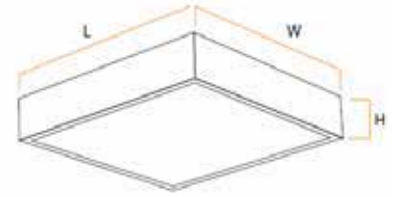

Ürün Kodu Product Code	Güç Power	Çıkış Işık Akısı Lumen Output	Verimlilik Efficiency	Işık Açısı Beam Angle	Işık Kaynağı Light Source	CRI	L (mm)	W (mm)	H (mm)
32042	26W	2600Lm	100Lm/W	120°	LED	80	300	300	65
32043	104W	10400Lm	100Lm/W	120°	LED	80	1200	300	65
32044	78W	7800Lm	100Lm/W	120°	LED	80	600	600	65
32045				120°	LED	80	∞	∞	65

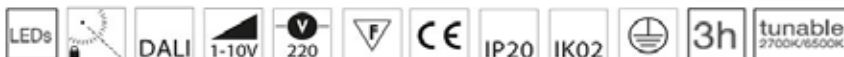

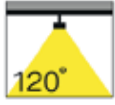

ÜRÜN ÖZELLİKLERİ/PRODUCT SPECIFICATIONS

Ürün Tanımı	Siva Üstü Lineer Armatür	Product Description	Surface Mounted Lineer Luminaire
Gövde	Alüminyum Ekstrüzyon Profil	Body	Aluminum Extrusion Profile
Boya / Kapak	Alüminyum Enjeksiyon	Paint / Cap	Aluminum Injection
Diğer Özellik		Other	
Lens		Lens	
Reflektör		Reflector	
Difüzör	Pleksi	Diffuser	Plexy
SDCM (MacAdam)	3	SDCM (MacAdam)	3
Renk Sıcaklığı	2700K/3000K/4000K	Colour Temperature	2700K/3000K/4000K
Ömür	50000h	Life Time	50000h
Çalışma Sıcaklığı	25°C	Operating Temperature	25°C
LED	Osram/Tridonic/Nichia Samsung/Cree	LED	Osram/Tridonic/Nichia Samsung/Cree
Sürücü		Driver	
Uygunluk	EN 60598-1 EN 60598-2-1	Conformity	EN 60598-1 EN 60598-2-1

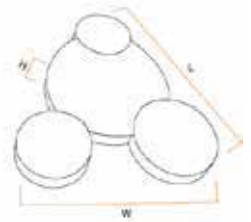

Ürün Kodu Product Code	Güç Power	Çıkış Işık Akısı Lumen Output	Verimlilik Efficiency	Işık Açısı Beam Angle	Işık Kaynağı Light Source	CRI	L (mm)	W (mm)	H (mm)
31208	156W	15600Lm	100Lm/W	120°	LED	80	900	1400	77
31209	156W	15600Lm	100Lm/W	120°	LED	80	900	1400	95
31210			100Lm/W	120°	LED	80	∞	∞	77
31211				120°	LED	80	∞	∞	95

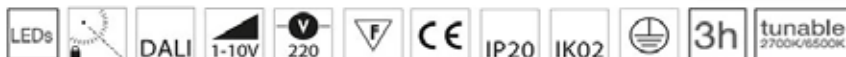

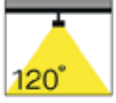

ÜRÜN ÖZELLİKLERİ/PRODUCT SPECIFICATIONS

Ürün Tanımı	Sıva Üstü Lineer Bulut Armatür
Gövde	Alüminyum Ekstrüzyon Profil
Boya / Kapak	Alüminyum Enjeksiyon
Diğer Özellik	
Lens	
Reflektör	
Difüzör	Pleksi
SDCM (MacAdam)	3
Renk Sıcaklığı	2700K/3000K/4000K
Ömür	50000h
Çalışma Sıcaklığı	25°C
LED	Osram/Tridonic/Nichia Samsung/Cree
Sürücü	
Uygunluk	EN 60598-1 EN 60598-2-1

Product Description	Surface Mounted Lineer Cloud Luminaire
Body	Aluminum Extrusion Profile
Paint / Cap	Aluminum Injection
Other	
Lens	
Reflector	
Diffuser	Plexy
SDCM (MacAdam)	3
Colour Temperature	2700K/3000K/4000K
Life Time	50000h
Operating Temperature	25°C
LED	Osram/Tridonic/Nichia Samsung/Cree
Sürücü	
Conformity	EN 60598-1 EN 60598-2-1

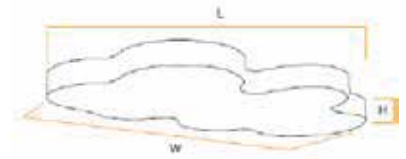

Ürün Kodu Product Code	Güç Power	Çıkış Işık Akısı Lumen Output	Verimlilik Efficiency	Işık Açısı Beam Angle	Işık Kaynağı Light Source	CRI	L (mm)	W (mm)	H (mm)
31221	260W	26000Lm	100Lm/W	120°	LED	80	1630	550	77
31222			100Lm/W	120°	LED	80	∞	∞	77

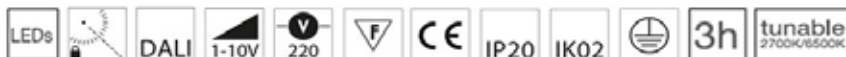

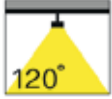
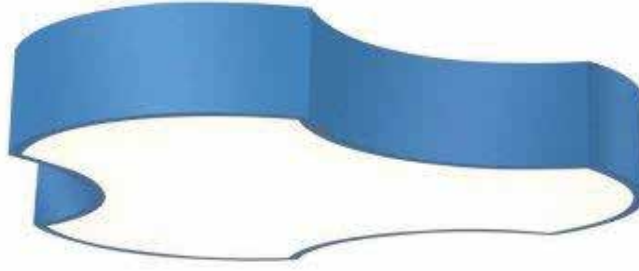

ÜRÜN ÖZELLİKLERİ/PRODUCT SPECIFICATIONS

Ürün Tanımı	Siva Üstü Lineer Armatür	Product Descripton	Surface Mounted Lineer Luminaire
Gövde	Alüminyum Ekstrüzyon Profil	Body	Aluminum Extrusion Profile
Boya / Kapak	Alüminyum Enjeksiyon	Paint / Cap	Aluminum Injection
Diğer Özellik		Other	
Lens		Lens	
Reflektör		Reflector	
Difüzör	Pleksi	Diffuser	Plexy
SDCM (MacAdam)	3	SDCM (MacAdam)	3
Renk Sıcaklığı	2700K/3000K/4000K	Colour Temperature	2700K/3000K/4000K
Ömür	50000h	Life Time	50000h
Çalışma Sıcaklığı	25°C	Operating Temperature	25°C
LED	Osram/Tridonic/Nichia Samsung/Cree	LED	Osram/Tridonic/Nichia Samsung/Cree
Sürücü		Driver	
Uygunluk	EN 60598-1 EN 60598-2-1	Conformity	EN 60598-1 EN 60598-2-1

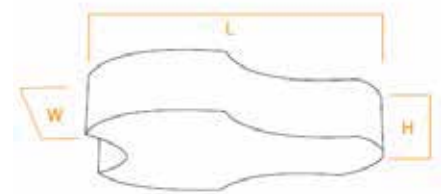

Ürün Kodu Product Code	Güç Power	Çıkış Işık Akısı Lumen Output	Verimlilik Efficiency	Işık Açısı Beam Angle	Işık Kaynağı Light Source	CRI	L (mm)	W (mm)	H (mm)
31205	26W	2080lm	80Lm/W	120°	LED	80	388	400	77
31206	43,6W	3480lm	80Lm/W	120°	LED	80	388	400	77
31207			80Lm/W	120°	LED	80	∞	400	77



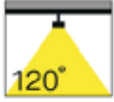

ÜRÜN ÖZELLİKLERİ/PRODUCT SPECIFICATIONS

Ürün Tanımı	Sıva Üstü Lineer Armatür	Product Descripton	Surface Mounted Lineer Luminaire
Gövde	Alüminyum Ekstrüzyon Profil	Body	Aluminum Extrusion Profile
Boya / Kapak	Alüminyum Enjeksiyon	Paint / Cap	Aluminum Injection
Diğer Özellik		Other	
Lens		Lens	
Reflektör		Reflector	
Difüzör	Pleksi	Diffuser	Plexy
SDCM (MacAdam)	3	SDCM (MacAdam)	3
Renk Sıcaklığı	2700K/3000K/4000K	Colour Temperature	2700K/3000K/4000K
Ömür	50000h	Life Time	50000h
Çalışma Sıcaklığı	25°C	Operating Temperature	25°C
LED	Osram/Tridonic/Nichia Samsung/Cree	LED	Osram/Tridonic/Nichia Samsung/Cree
Sürücü		Driver	
Uygunluk	EN 60598-1 EN 60598-2-1	Conformity	EN 60598-1 EN 60598-2-1



Ürün Kodu Product Code	Güç Power	Çıkış Işık Akısı Lumen Output	Verimlilik Efficiency	Işık Açısı Beam Angle	Işık Kaynağı Light Source	CRI	L (mm)	W (mm)	H (mm)
31250	78W	9360Lm	120Lm/W	120°	LED	80	1467	250	77
31251			120Lm/W	120°	LED	80	∞	∞	77

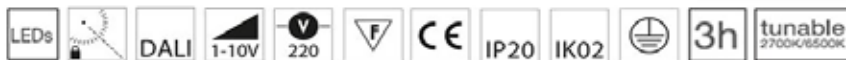



ÜRÜN ÖZELLİKLERİ/PRODUCT SPECIFICATIONS

Ürün Tanımı	Sıva Üstü Lineer Armatür	Product Description	Surface Mounted Linear Luminaire
Gövde	Alüminyum Ekstrüzyon Profil	Body	Aluminum Extrusion Profile
Boya / Kapak	Alüminyum Enjeksiyon	Paint / Cap	Aluminum Injection
Diğer Özellik		Other	
Lens		Lens	
Reflektör		Reflector	
Difüzör	Pleksi	Diffuser	Plexy
SDCM (MacAdam)	3	SDCM (MacAdam)	3
Renk Sıcaklığı	2700K/3000K/4000K	Colour Temperature	2700K/3000K/4000K
Ömür	50000h	Life Time	50000h
Çalışma Sıcaklığı	25°C	Operating Temperature	25°C
LED	Osram/Tridonic/Nichia Samsung/Cree	LED	Osram/Tridonic/Nichia Samsung/Cree
Sürücü		Driver	
Uygunluk	EN 60598-1 EN 60598-2-1	Conformity	EN 60598-1 EN 60598-2-1

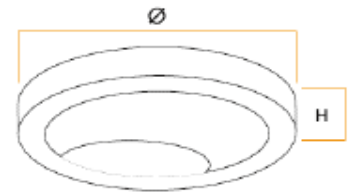

Ürün Kodu Product Code	Güç Power	Çıkış Işık Akısı Lumen Output	Verimlilik Efficiency	Işık Açısı Beam Angle	Işık Kaynağı Light Source	CRI	Ø (mm)	H (mm)
31171	65W	6500Lm	100Lm/W	120°	LED	80	600	77
31172	139W	13900Lm	100Lm/W	120°	LED	80	1200	77
31173	65W	6500Lm	100Lm/W	120°	LED	80	600	95
31174	139W	13900Lm	100Lm/W	120°	LED	80	1200	95
31175			100Lm/W	120°	LED	80	∞	77
31176			100Lm/W	120°	LED	80	∞	95



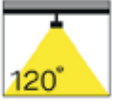

ÜRÜN ÖZELLİKLERİ/PRODUCT SPECIFICATIONS

Ürün Tanımı	Siva Üstü Lineer Armatür	Product Description	Surface Mounted Lineer Luminaire
Gövde	Alüminyum Ekstrüzyon Profil	Body	Aluminum Extrusion Profile
Boya / Kapak	Alüminyum Enjeksiyon	Paint / Cap	Aluminum Injection
Diğer Özellik		Other	
Lens		Lens	
Reflektör		Reflector	
Difüzör	Pleksi	Diffuser	Plexy
SDCM (MacAdam)	3	SDCM (MacAdam)	3
Renk Sıcaklığı	2700K/3000K/4000K	Colour Temperature	2700K/3000K/4000K
Ömür	50000h	Life Time	50000h
Çalışma Sıcaklığı	25°C	Operating Temperature	25°C
LED	Osram/Tridonic/Nichia Samsung/Cree	LED	Osram/Tridonic/Nichia Samsung/Cree
Sürücü		Driver	
Uygunluk	EN 60598-1 EN 60598-2-1	Conformity	EN 60598-1 EN 60598-2-1

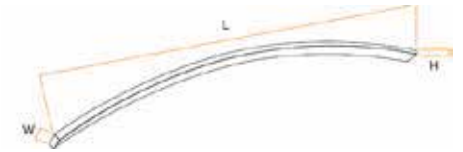

Ürün Kodu Product Code	Güç Power	Çıkış Işık Akısı Lumen Output	Verimlilik Efficiency	Işık Açısı Beam Angle	Işık Kaynağı Light Source	CRI	L (mm)	W (mm)	H (mm)
31256	30W	2700Lm	90Lm/W	120°	LED	80	1000	62	20
31257	36W	3240Lm	90Lm/W	120°	LED	80	1200	62	20
31258	39W	3510Lm	90Lm/W	120°	LED	80	1500	62	20
31259	52W	4680Lm	90Lm/W	120°	LED	80	2000	62	20
31260	78W	7020Lm	90Lm/W	120°	LED	80	3000	62	20
31261	30W/m	2700Lm/m	90Lm/W	120°	LED	80	∞	62	20

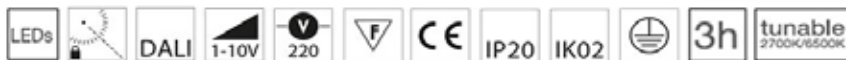

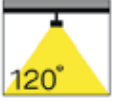

ÜRÜN ÖZELLİKLERİ/PRODUCT SPECIFICATIONS

Ürün Tanımı	Sıva Üstü Lineer Armatür	Product Description	Surface Mounted Lineer Luminaire
Gövde	Alüminyum Ekstrüzyon Profil	Body	Aluminum Extrusion Profile
Boya / Kapak	Alüminyum Enjeksiyon	Paint / Cap	Aluminum Injection
Diğer Özellik		Other	
Lens		Lens	
Reflektör		Reflector	
Difüzör	Pleksi	Diffuser	Plexy
SDCM (MacAdam)	3	SDCM (MacAdam)	3
Renk Sıcaklığı	2700K/3000K/4000K	Colour Temperature	2700K/3000K/4000K
Ömür	50000h	Life Time	50000h
Çalışma Sıcaklığı	25°C	Operating Temperature	25°C
LED	Osram/Tridonic/Nichia Samsung/Cree	LED	Osram/Tridonic/Nichia Samsung/Cree
Sürücü		Driver	
Uygunluk	EN 60598-1 EN 60598-2-1	Conformity	EN 60598-1 EN 60598-2-1



Ürün Kodu Product Code	Güç Power	Çıkış Işık Akısı Lumen Output	Verimlilik Efficiency	Işık Açısı Beam Angle	Işık Kaynağı Light Source	CRI	L (mm)	W (mm)	H (mm)
31232	47,6W	4290Lm	90Lm/W	120°	LED	80	1000	300	77
31233	57W	5148Lm	90Lm/W	120°	LED	80	1200	300	77
31234	71,4W	6435Lm	90Lm/W	120°	LED	80	1500	300	77
31235	95,2W	8580Lm	90Lm/W	120°	LED	80	2000	300	77
31236	142,8W	12870Lm	90Lm/W	120°	LED	80	3000	300	77
31237	47,6W/m	4290Lm/m	90Lm/W	120°	LED	80	∞	300	77



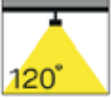

ÜRÜN ÖZELLİKLERİ/PRODUCT SPECIFICATIONS

ÜRÜN TANIMI	Ürün Tanımı	Product Description	Surface Mounted Lineer Luminaire
Gövde	Alüminyum Ekstrüzyon Profil	Body	Aluminum Extrusion Profile
Boya / Kapak	Alüminyum Enjeksiyon	Paint / Cap	Aluminum Injection
Diğer Özellik		Other	
Lens		Lens	
Reflektör		Reflector	
Difüzör	Pleksi	Diffuser	Plexy
SDCM (MacAdam)	3	SDCM (MacAdam)	3
Renk Sıcaklığı	2700K/3000K/4000K	Colour Temperature	2700K/3000K/4000K
Ömür	50000h	Life Time	50000h
Çalışma Sıcaklığı	25°C	Operating Temperature	25°C
LED	Osram/Tridonic/Nichia Samsung/Cree	LED	Osram/Tridonic/Nichia Samsung/Cree
Sürücü		Driver	
Uygunluk	EN 60598-1 EN 60598-2-1	Conformity	EN 60598-1 EN 60598-2-1



Ürün Kodu Product Code	Güç Power	Çıkış Işık Akısı Lumen Output	Verimlilik Efficiency	Işık Açısı Beam Angle	Işık Kaynağı Light Source	CRI	L (mm)	W (mm)	H (mm)
31223	32,5W	2880Lm/4880Lm	80Lm/W	120°	LED	80	1500	110	77
31224	65W	5850Lm/9800Lm	80Lm/W	120°	LED	80	2800	110	77
31225			80Lm/W	120°	LED	80	∞	110	77



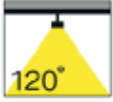
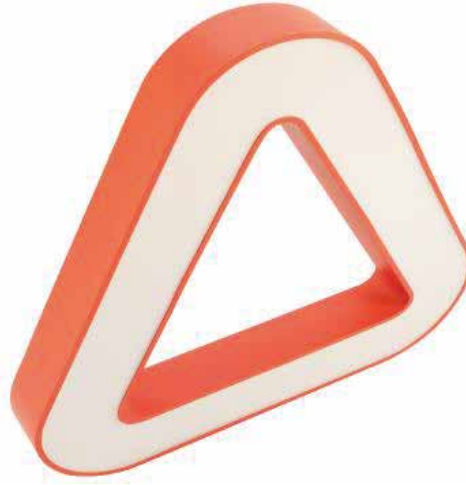

ÜRÜN ÖZELLİKLERİ/PRODUCT SPECIFICATIONS

Ürün Tanımı	Siva Üstü Lineer Armatür	Product Description	Surface Mounted Lineer Luminaire
Gövde	Alüminyum Ekstrüzyon Profil	Body	Aluminum Extrusion Profile
Boya / Kapak		Paint / Cap	
Diğer Özellik		Other	
Lens		Lens	
Reflektör		Reflector	
Difüzör	Pleksi	Diffuser	Plexy
SDCM (MacAdam)	3	SDCM (MacAdam)	3
Renk Sıcaklığı	2700K/3000K/4000K	Colour Temperature	2700K/3000K/4000K
Ömür	50000h	Life Time	50000h
Çalışma Sıcaklığı	25°C	Operating Temperature	25°C
LED	Osram/Tridonic/Nichia Samsung/Cree	LED	Osram/Tridonic/Nichia Samsung/Cree
Sürücü		Sürücü	
Uygunluk	EN 60598-1 EN 60598-2-1	Conformity	EN 60598-1 EN 60598-2-1

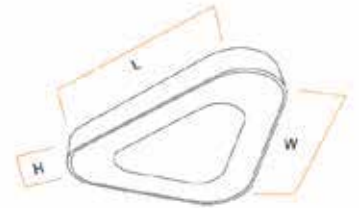

Ürün Kodu Product Code	Güç Power	Çıkış Işık Akısı Lumen Output	Verimlilik Efficiency	Işık Açısı Beam Angle	Işık Kaynağı Light Source	CRI	L (mm)	W (mm)	H (mm)
31269	39,5W	3510Lm	88Lm/W	120°	LED	80	600	600	77
31270	78W	7020Lm	90Lm/W	120°	LED	80	1200	1200	77
31271				120°	LED	80	∞	∞	77



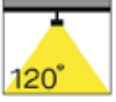
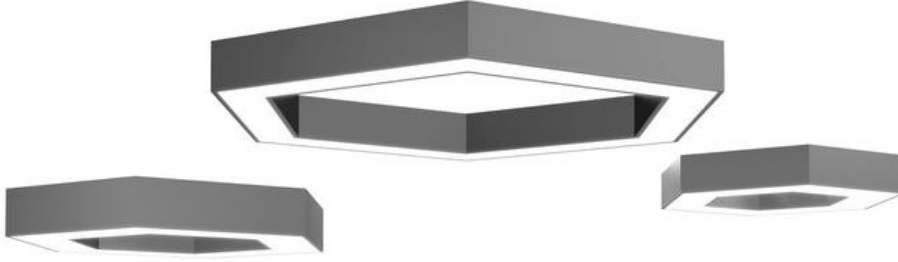

ÜRÜN ÖZELLİKLERİ/PRODUCT SPECIFICATIONS

Ürün Tanımı	Siva Üstü Lineer Armatür	Product Description	Surface Mounted Lineer Luminaire
Gövde	Alüminyum Ekstrüzyon Profil	Body	Aluminum Extrusion Profile
Boya / Kapak	Alüminyum Enjeksiyon	Paint / Cap	Aluminum Injection
Diğer Özellik		Other	
Lens		Lens	
Reflektör		Reflector	
Difüzör	Pleksi	Diffuser	Plexy
SDCM (MacAdam)	3	SDCM (MacAdam)	3
Renk Sıcaklığı	2700K/3000K/4000K	Colour Temperature	2700K/3000K/4000K
Ömür	50000h	Life Time	50000h
Çalışma Sıcaklığı	25°C	Operating Temperature	25°C
LED	Osram/Tridonic/Nichia Samsung/Cree	LED	Osram/Tridonic/Nichia Samsung/Cree
Sürücü		Sürücü	
Uygunluk	EN 60598-1 EN 60598-2-1	Conformity	EN 60598-1 EN 60598-2-1



Ürün Kodu Product Code	Güç Power	Çıkış Işık Akısı Lumen Output	Verimlilik Efficiency	Işık Açısı Beam Angle	Işık Kaynağı Light Source	CRI	L (mm)	W (mm)	H (mm)
31284	78W	7020Lm	90Lm/W	120°	LED	80	600	110	77
31285	156W	14040Lm	90Lm/W	120°	LED	80	1200	110	77
31286				120°	LED	80	∞	110	77



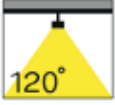

ÜRÜN ÖZELLİKLERİ/PRODUCT SPECIFICATIONS

Ürün Tanımı	Sıva Üstü Y Lineer Armatür	Product Description	Surface
Gövde	Alüminyum Ekstrüzyon Profil	Body	Aluminum Extrusion Profile
Boya / Kapak	Alüminyum Enjeksiyon	Paint / Cap	Aluminum Injection
Diğer Özellik		Other	
Lens		Lens	
Reflektör		Reflector	
Difüzör	Pleksi	Diffuser	Plexy
SDCM (MacAdam)	3	SDCM (MacAdam)	3
Renk Sıcaklığı	2700K/3000K/4000K	Colour Temperature	2700K/3000K/4000K
Ömür	50000h	Life Time	50000h
Çalışma Sıcaklığı	25°C	Operating Temperature	25°C
LED	Osram/Tridonic/Nichia Samsung/Cree	LED	Osram/Tridonic/Nichia Samsung/Cree
Sürücü		Sürücü	
Uygunluk	EN 60598-1 EN 60598-2-1	Conformity	EN 60598-1 EN 60598-2-1



Ürün Kodu Product Code	Güç Power	Çıkış Işık Akısı Lumen Output	Verimlilik Efficiency	Işık Açısı Beam Angle	Işık Kaynağı Light Source	CRI	Ø (mm)	H (mm)
31218	39W/65,4W	3510Lm/5886Lm	80Lm/W	120°	LED	80	1200	77
31219	78W/130,8W	7020Lm/11772Lm	80Lm/W	120°	LED	80	2400	77
31220	W	Lm	Lm/W	120°	LED	80	∞	77



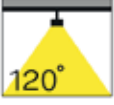

ÜRÜN ÖZELLİKLERİ/PRODUCT SPECIFICATIONS

Ürün Tanımı	Sıva Üstü Lineer Armatür	Product Description	Surface Mounted Lineer Luminaire
Gövde	Alüminyum Ekstrüzyon Profil	Body	Aluminum Extrusion Profile
Boya / Kapak	Alüminyum Enjeksiyon	Paint / Cap	Aluminum Injection
Diğer Özellik		Other	
Lens		Lens	
Reflektör		Reflector	
Difüzör	Pleksi	Diffuser	Plexy
SDCM (MacAdam)	3	SDCM (MacAdam)	3
Renk Sıcaklığı	2700K/3000K/4000K	Colour Temperature	2700K/3000K/4000K
Ömür	50000h	Life Time	50000h
Çalışma Sıcaklığı	25°C	Operating Temperature	25°C
LED	Osram/Tridonic/Nichia Samsung/Cree	LED	Osram/Tridonic/Nichia Samsung/Cree
Sürücü		Driver	
Uygunluk	EN 60598-1 EN 60598-2-1	Conformity	EN 60598-1 EN 60598-2-1



Ürün Kodu Product Code	Güç Power	Çıkış Işık Akısı Lumen Output	Verimlilik Efficiency	Işık Açısı Beam Angle	Işık Kaynağı Light Source	CRI	L (mm)	H (mm)
31278	65W	6500Lm	100Lm/W	120°	LED	80	600	77
31279	292W	29200Lm	100Lm/W	120°	LED	80	1200	77
31280	65W	6500Lm	100Lm/W	120°	LED	80	600	95
31281	292W	29200Lm	100Lm/W	120°	LED	80	1200	95
31282				120°	LED	80	∞	77
31283				120°	LED	80	∞	95



Sıva Altı

Lineer



SOHO
Light Design

Recessed

Lineer



ÜRÜN ÖZELLİKLERİ/PRODUCT SPECIFICATIONS

Ürün Tanımı	Sıva Altı Lineer Armatür	Product Descripton	Recessed Lineer Luminaire
Gövde	Alüminyum Ekstrüzyon Profil	Body	Aluminum Extrusion Profile
Boya / Kapak	Alüminyum Enjeksiyon	Paint / Cap	Aluminum Injection
Diğer Özellik		Other	
Lens		Lens	
Reflektör		Reflector	
Difüzör	Özel Lens Difüzör	Diffuser	Custom Lens Diffuser
SDCM (MacAdam)	3	SDCM (MacAdam)	3
Renk Sıcaklığı	2700K/3000K/4000K	Colour Temperature	2700K/3000K/4000K
Ömür	50000h	Life Time	50000h
Çalışma Sıcaklığı	25°C	Operating Temperature	25°C
LED	Osram/Tridonic/Samsung/Cree	LED	Osram/Tridonic/Samsung/Cree
Sürücü	Tridonic	Driver	Tridonic
Uygunluk	EN 60598-1 EN 60598-2-1	Conformity	EN 60598-1 EN 60598-2-1



Ürün Kodu Product Code	Güç Power	Çıkış Işık Akısı Lumen Output	Verimlilik Efficiency	Işık Açısı Beam Angle	Işık Kaynağı Light Source	CRI	L/L1 (mm)	W/W1 (mm)	H (mm)
33065	5x1W	500Lm	100Lm/W	34°	LED	80+	∞	45/36	33
33066	5x1,5W	750Lm	150Lm/W	34°	LED	80+	∞	45/36	33
33079	5x2W	1000Lm	200Lm/W	34°	LED	80+	∞	45/36	33





ÜRÜN ÖZELLİKLERİ/PRODUCT SPECIFICATIONS

Ürün Tanımı	Sıva Altı Lineer Armatür	Product Description	Recessed Linear Luminaire
Gövde	Alüminyum Ekstrüzyon Profil	Body	Aluminum Extrusion Profile
Boya / Kapak	Alüminyum Enjeksiyon	Paint / Cap	Aluminum Injection
Diğer Özellik		Other	
Lens		Lens	
Reflektör		Reflector	
Difüzör	Pleksi	Diffuser	Plexy
SDCM (MacAdam)	3	SDCM (MacAdam)	3
Renk Sıcaklığı	2700K/3000K/4000K	Colour Temperature	2700K/3000K/4000K
Ömür	50000h	Life Time	50000h
Çalışma Sıcaklığı	25°C	Operating Temperature	25°C
LED	Osram/Tridonic/Nichia Samsung/Cree	LED	Osram/Tridonic/Nichia Samsung/Cree
Sürücü		Driver	
Uygunluk	EN 60598-1 EN 60598-2-1	Conformity	EN 60598-1 EN 60598-2-1



Ürün Kodu Product Code	Güç Power	Çıkış Işık Akısı Lumen Output	Verimlilik Efficiency	Işık Açısı Beam Angle	Işık Kaynağı Light Source	CRI	L/L1 (mm)	W/W1 (mm)	H (mm)
33004	26W	2080Lm	80Lm/W	120°	LED	80	1000/990	42/34	41
33005	31,2W	2496Lm	80Lm/W	120°	LED	80	1200/1190	42/34	41
33006	39W	3120Lm	80Lm/W	120°	LED	80	1500/1490	42/34	41
33007	52W	4160Lm	80Lm/W	120°	LED	80	2000/1990	42/34	41
33008	78W	6240Lm	80Lm/W	120°	LED	80	3000/2900	42/34	41
33009	26W/m	2080Lm/m	80Lm/W	120°	LED	80	∞	42/34	41





ÜRÜN ÖZELLİKLERİ/PRODUCT SPECIFICATIONS

Ürün Tanımı	Sıva Altı Lineer Armatür	Product Description	Recessed Linear Luminaire
Gövde	Alüminyum Ekstrüzyon Profil	Body	Aluminum Extrusion Profile
Boya / Kapak	Alüminyum Enjeksiyon	Paint / Cap	Aluminum Injection
Diğer Özellik		Other	
Lens		Lens	
Reflektör		Reflector	
Difüzör	Pleksi	Diffuser	Plexy
SDCM (MacAdam)	3	SDCM (MacAdam)	3
Renk Sıcaklığı	2700K/3000K/4000K	Colour Temperature	2700K/3000K/4000K
Ömür	50000h	Life Time	50000h
Çalışma Sıcaklığı	25°C	Operating Temperature	25°C
LED	Osram/Tridonic/Nichia Samsung/Cree	LED	Osram/Tridonic/Nichia Samsung/Cree
Sürücü		Driver	
Uygunluk	EN 60598-1 EN 60598-2-1	Conformity	EN 60598-1 EN 60598-2-1

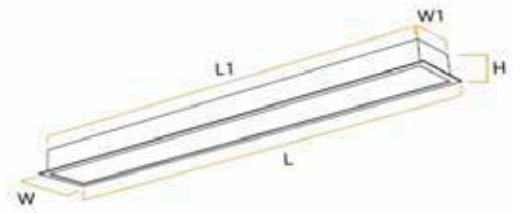

Ürün Kodu Product Code	Güç Power	Çıkış Işık Akısı Lumen Output	Verimlilik Efficiency	Işık Açısı Beam Angle	Işık Kaynağı Light Source	CRI	L/L1 (mm)	W/W1 (mm)	H (mm)
33010	26W	2080Lm	80Lm/W	120°	LED	80	1000/990	67/55	70
33011	31,2W	2496Lm	80Lm/W	120°	LED	80	1200/1190	67/55	70
33012	39W	3120Lm	80Lm/W	120°	LED	80	1500/1490	67/55	70
33013	52W	4160Lm	80Lm/W	120°	LED	80	2000/1990	67/55	70
33014	78W	6240Lm	80Lm/W	120°	LED	80	3000/2900	67/55	70
33015	26W/m	2080Lm/m	80Lm/W	120°	LED	80	∞	67/55	70



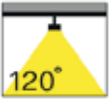

ÜRÜN ÖZELLİKLERİ/PRODUCT SPECIFICATIONS

Ürün Tanımı	Siva Altı Lineer Armatür	Product Descripton	Recessed Lineer Luminaire
Gövde	Alüminyum Ekstrüzyon Profil	Body	Aluminum Extrusion Profile
Boya / Kapak	Alüminyum Enjeksiyon	Paint / Cap	Aluminum Injection
Diğer Özellik		Other	
Lens		Lens	
Reflektör		Reflector	
Difüzör	Pleksi	Diffuser	Plexy
SDCM (MacAdam)	3	SDCM (MacAdam)	3
Renk Sıcaklığı	2700K/3000K/4000K	Colour Temperature	2700K/3000K/4000K
Ömür	50000h	Life Time	50000h
Çalışma Sıcaklığı	25°C	Operating Temperature	25°C
LED	Osram/Tridonic/Nichia Samsung/Cree	LED	Osram/Tridonic/Nichia Samsung/Cree
Sürücü		Driver	
Uygunluk	EN 60598-1 EN 60598-2-1	Conformity	EN 60598-1 EN 60598-2-1

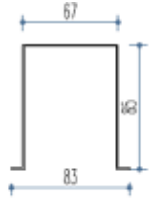

Ürün Kodu Product Code	Güç Power	Çıkış Işık Akısı Lumen Output	Verimlilik Efficiency	Işık Açısı Beam Angle	Işık Kaynağı Light Source	CRI	L/L1 (mm)	W/W1 (mm)	H (mm)
33022	26W	2080Lm	80Lm/W	120°	LED	80	1000/990	83/73	85
33023	31,2W	2496Lm	80Lm/W	120°	LED	80	1200/1190	83/73	85
33024	39W	3120Lm	80Lm/W	120°	LED	80	1500/1490	83/73	85
33025	52W	4160Lm	80Lm/W	120°	LED	80	2000/1990	83/73	85
33026	78W	6240Lm	80Lm/W	120°	LED	80	3000/2990	83/73	85
33027	26W/m	2080Lm/m	80Lm/W	120°	LED	80	∞	83/73	85



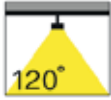

ÜRÜN ÖZELLİKLERİ/PRODUCT SPECIFICATIONS

Ürün Tanımı	Sıva Altı Lineer Armatür	Product Description	Recessed Li
Gövde	Alüminyum Ekstrüzyon Profil	Body	Aluminum I
Boya / Kapak	Alüminyum Enjeksiyon	Paint / Cap	Aluminum I
Diğer Özellik		Other	
Lens		Lens	
Reflektör		Reflector	
Difüzör	Pleksi	Diffuser	Plexy
SDCM (MacAdam)	3	SDCM (MacAdam)	3
Renk Sıcaklığı	2700K/3000K/4000K	Colour Temperature	2700K/3000K/4000K
Ömür	50000h	Life Time	50000h
Çalışma Sıcaklığı	25°C	Operating Temperature	25°C
LED	Osram/Tridonic/Nichia Samsung/Cree	LED	Osram/Tridonic/Nichia Samsung/Cree
Sürücü		Driver	
Uygunluk	EN 60598-1 EN 60598-2-1	Conformity	EN 60598-1 EN 60598-2-1



Ürün Kodu Product Code	Güç Power	Çıkış Işık Akısı Lumen Output	Verimlilik Efficiency	Işık Açısı Beam Angle	Işık Kaynağı Light Source	CRI	L/L1 (mm)	W/W1 (mm)	H (mm)
33028	26W	2080Lm	80Lm/W	120°	LED	80	1000/990	95/85	92
33029	31,2W	2496Lm	80Lm/W	120°	LED	80	1200/1190	95/85	92
33030	39W	3120Lm	80Lm/W	120°	LED	80	1500/1490	95/85	92
33031	52W	4160Lm	80Lm/W	120°	LED	80	2000/1990	95/85	92
33032	78W	6240Lm	80Lm/W	120°	LED	80	3000/2990	95/85	92
33033	26W/m	2080Lm/m	80Lm/W	120°	LED	80	∞	95/85	92

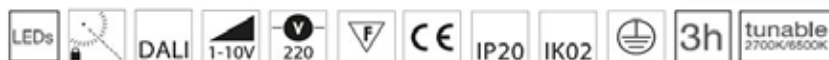



ÜRÜN ÖZELLİKLERİ/PRODUCT SPECIFICATIONS

Ürün Tanımı	Sıva Altı Lineer Armatür	Product Description	Recessed Linear Luminaire
Gövde	Alüminyum Ekstrüzyon Profil	Body	Aluminum Extrusion Profile
Boya / Kapak	Alüminyum Enjeksiyon	Paint / Cap	Aluminum Injection
Diğer Özellik		Other	
Lens		Lens	
Reflektör		Reflector	
Difüzör	Pleksi	Diffuser	Plexy
SDCM (MacAdam)	3	SDCM (MacAdam)	3
Renk Sıcaklığı	2700K/3000K/4000K	Colour Temperature	2700K/3000K/4000K
Ömür	50000h	Life Time	50000h
Çalışma Sıcaklığı	25°C	Operating Temperature	25°C
LED	Osram/Tridonic/Nichia Samsung/Cree	LED	Osram/Tridonic/Nichia Samsung/Cree
Sürücü		Driver	
Uygunluk	EN 60598-1 EN 60598-2-1	Conformity	EN 60598-1 EN 60598-2-1

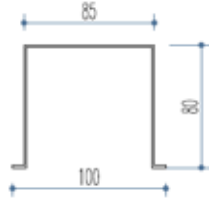

Ürün Kodu Product Code	Güç Power	Çıkış Işık Akısı Lumen Output	Verimlilik Efficiency	Işık Açısı Beam Angle	Işık Kaynağı Light Source	CRI	L/L1 (mm)	W/W1 (mm)	H (mm)
33034	26W	2080lm	80Lm/W	120°	LED	80	1000/990	100/88	80
33035	31,2W	2496lm	80Lm/W	120°	LED	80	1200/1190	100/88	80
33036	39W	3120lm	80Lm/W	120°	LED	80	1500/1490	100/88	80
33037	52W	4160lm	80Lm/W	120°	LED	80	2000/1990	100/88	80
33038	78W	6240lm	80Lm/W	120°	LED	80	3000/2990	100/88	80
33039	26W/m	2080Lm/m	80Lm/W	120°	LED	80	∞	100/88	80





ÜRÜN ÖZELLİKLERİ/PRODUCT SPECIFICATIONS

Ürün Tanımı	Siva Altı Lineer Armatür	Product Descripton	Recessed Lineer Luminaire
Gövde	Alüminyum Ekstrüzyon Profil	Body	Aluminum Extrusion Profile
Boya / Kapak	Alüminyum Enjeksiyon	Paint / Cap	Aluminum Injection
Diğer Özellik		Other	
Lens		Lens	
Reflektör		Reflector	
Difüzör	Pleksi	Diffuser	Plexy
SDCM (MacAdam)	3	SDCM (MacAdam)	3
Renk Sıcaklığı	2700K/3000K/4000K	Colour Temperature	2700K/3000K/4000K
Ömür	50000h	Life Time	50000h
Çalışma Sıcaklığı	25°C	Operating Temperature	25°C
LED	Osram/Tridonic/Nichia Samsung/Cree	LED	Osram/Tridonic/Nichia Samsung/Cree
Sürücü		Driver	
Uygunluk	EN 60598-1 EN 60598-2-1	Conformity	EN 60598-1 EN 60598-2-1



Ürün Kodu Product Code	Güç Power	Çıkış Işık Akısı Lumen Output	Verimlilik Efficiency	Işık Açısı Beam Angle	Işık Kaynağı Light Source	CRI	L/L1 (mm)	W/W1 (mm)	H (mm)
33040	26W	2080Lm	80Lm/W	120°	LED	80	1000/990	100/88	50
33041	31,2W	2496Lm	80Lm/W	120°	LED	80	1200/1190	100/88	50
33042	39W	3120Lm	80Lm/W	120°	LED	80	1500/1490	100/88	50
33043	52W	4160Lm	80Lm/W	120°	LED	80	2000/1990	100/88	50
33044	78W	6240Lm	80Lm/W	120°	LED	80	3000/2990	100/88	50
33045	26W/m	2080Lm/m	80Lm/W	120°	LED	80	∞	100/88	50



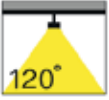

ÜRÜN ÖZELLİKLERİ/PRODUCT SPECIFICATIONS

Ürün Tanımı	Siva Altı Lineer Armatür	Product Descripton	Recessed Lineer Luminaire
Gövde	Alüminyum Ekstrüzyon Profil	Body	Aluminum Extrusion Profile
Boya / Kapak	Alüminyum Enjeksiyon	Paint / Cap	Aluminum Injection
Diğer Özellik		Other	
Lens		Lens	
Reflektör		Reflector	
Difüzör	Pleksi	Diffuser	Plexy
SDCM (MacAdam)	3	SDCM (MacAdam)	3
Renk Sıcaklığı	2700K/3000K/4000K	Colour Temperature	2700K/3000K/4000K
Ömür	50000h	Life Time	50000h
Çalışma Sıcaklığı	25°C	Operating Temperature	25°C
LED	Osram/Tridonic/Nichia Samsung/Cree	LED	Osram/Tridonic/Nichia Samsung/Cree
Sürücü		Driver	
Uygunluk	EN 60598-1 EN 60598-2-1	Conformity	EN 60598-1 EN 60598-2-1

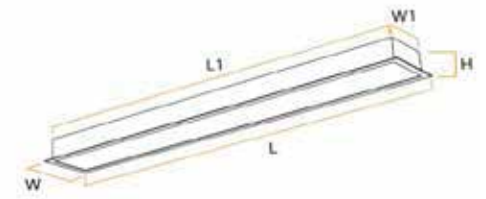

Ürün Kodu Product Code	Güç Power	Çıkış Işık Akısı Lumen Output	Verimlilik Efficiency	Işık Açısı Beam Angle	Işık Kaynağı Light Source	CRI	L/L1 (mm)	W/W1 (mm)	H (mm)
33016	2x26W	2x3120Lm	120Lm/W	120°	LED	80	1000/990	175/150	100
33017	2x31,2W	2x3744Lm	120Lm/W	120°	LED	80	1200/1190	175/150	100
33018	2x39W	2x4680Lm	120Lm/W	120°	LED	80	1500/1490	175/150	100
33019	2x52W	2x6240Lm	120Lm/W	120°	LED	80	2000/1990	175/150	100
33020	2x78W	2x9360Lm	120Lm/W	120°	LED	80	3000/2990	175/150	100
33021	2x26W/m	2x3120Lm/m	120Lm/W	120°	LED	80	∞	175/150	100



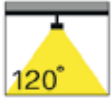

ÜRÜN ÖZELLİKLERİ/PRODUCT SPECIFICATIONS

Ürün Tanımı	Sıva Altı Lineer Halka Armatür	Product Descripton	Recessed Lineer Circle Luminaire
Gövde	Alüminyum Ekstrüzyon Profil	Body	Aluminum Extrusion Profile
Boya / Kapak	Alüminyum Enjeksiyon	Paint / Cap	Aluminum Injection
Diğer Özellik		Other	
Lens		Lens	
Reflektör		Reflector	
Difüzör	Pleksi	Diffuser	Plexy
SDCM (MacAdam)	3	SDCM (MacAdam)	3
Renk Sıcaklığı	2700K/3000K/4000K	Colour Temperature	2700K/3000K/4000K
Ömür	50000h	Life Time	50000h
Çalışma Sıcaklığı	25°C	Operating Temperature	25°C
LED	Osram/Tridonic/Nichia Samsung/Cree	LED	Osram/Tridonic/Nichia Samsung/Cree
Sürücü		Driver	
Uygunluk	EN 60598-1 EN 60598-2-1	Conformity	EN 60598-1 EN 60598-2-1

Ürün Kodu Product Code	Güç Power	Çıkış Işık Akısı Lumen Output	Verimlilik Efficiency	Işık Açısı Beam Angle	Işık Kaynağı Light Source	CRI	Ø (mm)	Ø1 (mm)	H (mm)
33067	20W	1885Lm	91Lm/W	120°	LED	80	300	77	100
33068	27W	2514Lm	91Lm/W	120°	LED	80	400	77	100
33069	34,5W	3143Lm	91Lm/W	120°	LED	80	500	77	100
33070	41W	3771Lm	91Lm/W	120°	LED	80	600	77	100
33071	69W	6286Lm	91Lm/W	120°	LED	80	1000	77	100
33072	∞W	∞Lm	91Lm/W	120°	LED	80	∞	∞	100



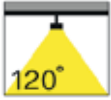
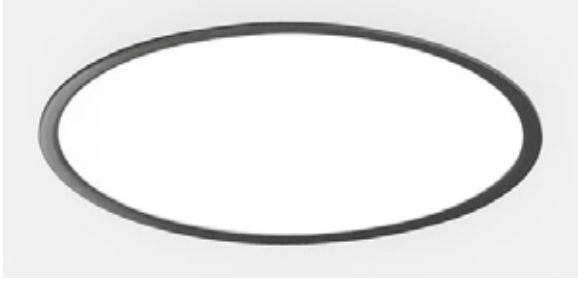

ÜRÜN ÖZELLİKLERİ/PRODUCT SPECIFICATIONS

Ürün Tanımı	Sıva Altı Lineer Halka Armatür	Product Descripton	Recessed Lineer Circle Luminaire
Gövde	Alüminyum Ekstrüzyon Profil	Body	Aluminum Extrusion Profile
Boya / Kapak	Alüminyum Enjeksiyon	Paint / Cap	Aluminum Injection
Diğer Özellik		Other	
Lens		Lens	
Reflektör		Reflector	
Difüzör	Pleksi	Diffuser	Plexy
SDCM (MacAdam)	3	SDCM (MacAdam)	3
Renk Sıcaklığı	2700K/3000K/4000K	Colour Temperature	2700K/3000K/4000K
Ömür	50000h	Life Time	50000h
Çalışma Sıcaklığı	25°C	Operating Temperature	25°C
LED	Osram/Tridonic/Nichia Samsung/Cree	LED	Osram/Tridonic/Nichia Samsung/Cree
Sürücü		Driver	
Uygunluk	EN 60598-1 EN 60598-2-1	Conformity	EN 60598-1 EN 60598-2-1

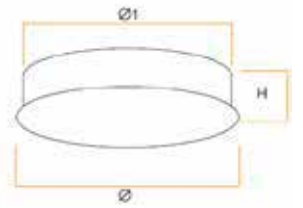

Ürün Kodu Product Code	Güç Power	Çıkış Işık Akısı Lumen Output	Verimlilik Efficiency	Işık Açısı Beam Angle	Işık Kaynağı Light Source	CRI	Ø (mm)	Ø1 (mm)	H (mm)
33052	26W	3120Lm	120Lm/W	120°	LED	80	300	288	77
33053	39W	4680Lm	120Lm/W	120°	LED	80	400	388	77
33054	50W	6000Lm	120Lm/W	120°	LED	80	500	488	77
33055	65W	7800Lm	120Lm/W	120°	LED	80	600	588	77
33056	143W	17160Lm	120Lm/W	120°	LED	80	800	788	77
33057	260W	31200Lm	120Lm/W	120°	LED	80	1000	988	95
33058	W	Lm	Lm/W		LED	80	∞	∞	95



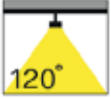

ÜRÜN ÖZELLİKLERİ/PRODUCT SPECIFICATIONS

Ürün Tanımı	Sıva Altı Lineer Armatür	Product Descripton	Recessed Lineer Luminaire
Gövde	Alüminyum Ekstrüzyon Profil	Body	Aluminum Extrusion Profile
Boya / Kapak	Alüminyum Enjeksiyon	Paint / Cap	Aluminum Injection
Diğer Özellik		Other	
Lens		Lens	
Reflektör		Reflector	
Difüzör	Pleksi	Diffuser	Plexy
SDCM (MacAdam)	3	SDCM (MacAdam)	3
Renk Sıcaklığı	2700K/3000K/4000K	Colour Temperature	2700K/3000K/4000K
Ömür	50000h	Life Time	50000h
Çalışma Sıcaklığı	25°C	Operating Temperature	25°C
LED	Osram/Tridonic/Nichia Samsung/Cree	LED	Osram/Tridonic/Nichia Samsung/Cree
Sürücü		Driver	
Uygunluk	EN 60598-1 EN 60598-2-1	Conformity	EN 60598-1 EN 60598-2-1

Ürün Kodu Product Code	Güç Power	Çıkış Işık Akısı Lumen Output	Verimlilik Efficiency	Işık Açısı Beam Angle	Işık Kaynağı Light Source	CRI	L (mm)	W (mm)	H (mm)
33073	26W	3120lm	120lm/W	120°	LED	80	300	300	77
33074	39W	4680lm	120lm/W	120°	LED	80	300	600	77
33075	50W	6000lm	120lm/W	120°	LED	80	600	600	77
33076	65W	7800lm	120lm/W	120°	LED	80	300	1200	77
33077	100W	12000lm	120lm/W	120°	LED	80	600	1200	77
33078	∞	∞	120lm/W	120°	LED	80	∞	∞	77





ÜRÜN ÖZELLİKLERİ/PRODUCT SPECIFICATIONS

Ürün Tanımı	Siva Altı Lineer Armatür	Product Descripton	Recessed Lineer Luminaire
Gövde	Alüminyum Ekstrüzyon Profil	Body	Aluminum Extrusion Profile
Boya / Kapak	Alüminyum Enjeksiyon	Paint / Cap	Aluminum Injection
Diğer Özellik		Other	
Lens		Lens	
Reflektör		Reflector	
Difüzör	Pleksi	Diffuser	Plexy
SDCM (MacAdam)	3	SDCM (MacAdam)	3
Renk Sıcaklığı	2700K/3000K/4000K	Colour Temperature	2700K/3000K/4000K
Ömür	50000h	Life Time	50000h
Çalışma Sıcaklığı	25°C	Operating Temperature	25°C
LED	Osram/Tridonic/Nichia Samsung/Cree	LED	Osram/Tridonic/Nichia Samsung/Cree
Sürücü		Driver	
Uygunluk	EN 60598-1 EN 60598-2-1	Conformity	EN 60598-1 EN 60598-2-1

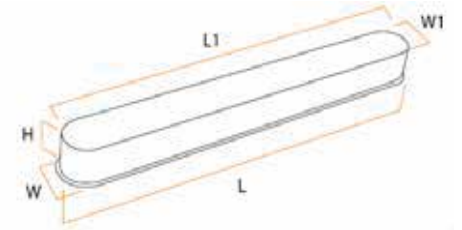

Ürün Kodu Product Code	Güç Power	Çıkış Işık Akısı Lumen Output	Verimlilik Efficiency	Işık Açısı Beam Angle	Işık Kaynağı Light Source	CRI	L/L1 (mm)	W/W1 (mm)	H (mm)
33046	26W	2080Lm	80Lm/W	120°	LED	80	1000/880	110/98	77
33047	31,2W	2496Lm	80Lm/W	120°	LED	80	1200/1080	110/98	77
33048	39W	3120Lm	80Lm/W	120°	LED	80	1500/1380	110/98	77
33049	52W	4160Lm	80Lm/W	120°	LED	80	2000/1880	110/98	77
33050	78W	6240Lm	80Lm/W	120°	LED	80	3000/2880	110/98	77
33051	26W/m	2080Lm/m	80Lm/W	120°	LED	80	∞	110/98	77



Panel Armatür



Panel Lumininaire

SIVA ALTI BACKLIGHT LED PANEL
RECESSED MOUNTED BACKLIGHT
LED PANEL

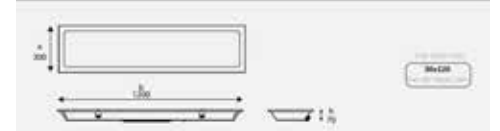
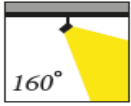

ÜRÜN ÖZELLİKLERİ/PRODUCT SPECIFICATIONS

Ürün Tanımı	Sıva Altı Backlight LED Panel	Product Descripton	Recessed Mounted Backlight LED Panel
Gövde	0,50mm DKP Sac 0,50mm DKP Saç Çerçeve	Body	0,50mm DKP Sheet 0,50mm DKP Sheet Frame
Boya	Elektrostatik Toz Boya	Paint	Electrostatic Powder Coated
PCB		PCB	
Lens		Lens	
Reflektör		Reflector	High Transmittance Opal Diffuser
Difüzör	Yüksek Geçirgenliğe Sahip Opal Difüzör	Diffuser	High Transmittance Opal Diffuser
SDCM (MacAdam)	3	SDCM (MacAdam)	3
Renk Sıcaklığı	2700K-6500K	Colour Temperature	2700K-6500K
Ömür	50000h	Life Time	50000h
Çalışma Sıcaklığı	-20° ~ +50°C	Operating Temperature	-20° ~ +50°C
LED	Osram/Samsung	LED	Osram/Samsung
Sürücü	Osram/Philips/Tridonic	Driver	Osram/Philips/Tridonic
Uygunluk	EN 60598-2-2	Conformity	EN 60598-2-2

Ürün Kodu Product Code	Güç Power	Çıkış Işık Akısı Lumen Output	Verimlilik Efficiency	Işık Açısı Beam Angle	Işık Kaynağı Light Source	CRI	L (mm)	W (mm)	H (mm)
92001	15W	1494Lm	100Lm/W	160°	LED	>0,95	300	300	70
92002	18W	1945Lm	108Lm/W	160°	LED	>0,95	300	600	70
92003	23W	2345Lm	102Lm/W	160°	LED	>0,95	300	600	70
92004	31W	3742Lm	120Lm/W	160°	LED	>0,95	300	1200	70
92005	40W	4105Lm	103Lm/W	160°	LED	>0,95	300	1200	70
92006	45W	4709Lm	105Lm/W	160°	LED	>0,95	300	1200	70
92007	31W	3609Lm	116Lm/W	160°	LED	>0,95	595	595	70
92008	34W	4054Lm	119Lm/W	160°	LED	>0,95	595	595	70
92009	40W	4402Lm	110Lm/W	160°	LED	>0,95	595	595	70
92010	44W	4968Lm	113Lm/W	160°	LED	>0,95	595	595	70
92011	63W	7772Lm	123Lm/W	160°	LED	>0,95	600	1200	70
92012	80W	9384Lm	117Lm/W	160°	LED	>0,95	600	1200	70



SIVA ALTI BACKLIGHT LED PANEL
RECESSED MOUNTED BACKLIGHT
LED PANEL



ÜRÜN ÖZELLİKLERİ/PRODUCT SPECIFICATIONS

Ürün Tanımı	Sıva Altı Backlight LED Slim Panel	Product Description	Recessed Mounted Backlight LED Slim Panel
Gövde	Alüminyum Çerçeve 0,25mm DKP Sac	Body	Aluminium Frame 0,25mm DKP Sheet
Boya	Elektrostatik Toz Boya	Paint	Electrostatic Powder Coated
PCB		PCB	
Lens		Lens	
Reflektör		Reflector	
Difüzör	Polistiren Difüzör	Diffuser	High Transmittance Opal Diffuser
SDCM (MacAdam)	3	SDCM (MacAdam)	3
Renk Sıcaklığı	2700K-6500K	Colour Temperature	2700K-6500K
Ömür	50000h	Life Time	50000h
Çalışma Sıcaklığı	-20° ~ +50°C	Operating Temperature	-20° ~ +50°C
LED	Osram/Nichia	LED	Osram/Nichia
Sürücü	Osram/Samsung	Driver	Osram/Samsung
Uygunluk	Osram/Philips/Tridonic	Conformity	Osram/Philips/Tridonic

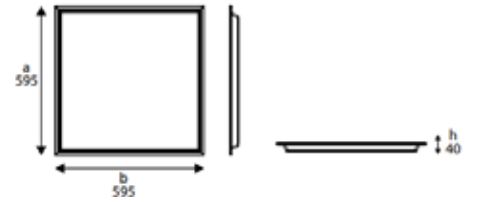

Ürün Kodu Product Code	Güç Power	Çıkış Işık Akısı Lumen Output	Verimlilik Efficiency	Işık Açısı Beam Angle	Işık Kaynağı Light Source	CRI	L (mm)	W (mm)	H (mm)
92047	34W	3316Lm	97Lm/W	160°	LED	>0,95	596	596	40
92048	40W	3772Lm	95Lm/W	160°	LED	>0,95	596	596	40



SIVA ALTI BACKLIGHT LED PANEL
RECESSED MOUNTED BACKLIGHT
LED PANEL



ÜRÜN ÖZELLİKLERİ/PRODUCT SPECIFICATIONS

Ürün Tanımı	Sıva Altı Slim LED Panel	Product Description	Recessed Mounted Slim LED Panel
Gövde	Alüminyum 0,25mm DKP Sac 1mm Alüminyum Extrüzyon Çerçeve	Body	Aluminum 0,25mm DKP Sheet 1mm Aluminum Extrusion Frame
Boya	Elektrostatik Toz Boya	Paint	Electrostatic Powder Coated
PCB		PCB	
Lens		Lens	
Reflektör		Reflector	High Transmittance Opal Diffuser
Difüzör	Yüksek Geçirgenliğe Sahip Polistiren Difüzör	Diffuser	High Transmittance Polystyrene Diffuser
SDCM (MacAdam)	3	SDCM (MacAdam)	3
Renk Sıcaklığı	2700K-6500K	Colour Temperature	2700K-6500K
Ömür	50000h	Life Time	50000h
Çalışma Sıcaklığı	-20° ~ +50°C	Operating Temperature	-20° ~ +50°C
LED	Osram/Samsung	LED	Osram/Samsung
Sürücü	Osram/Philips/Tridonic	Driver	Osram/Philips/Tridonic
Uygunluk	EN 60598-2-2	Conformity	EN 60598-2-2

Ürün Kodu Product Code	Güç Power	Çıkış Işık Akısı Lumen Output	Verimlilik Efficiency	Işık Açısı Beam Angle	Işık Kaynağı Light Source	CRI	L (mm)	W (mm)	H (mm)
92023	24W	1944Lm	81Lm/W	160°	LED	>0,95	295	295	30
92024	30W	2430Lm	81Lm/W	160°	LED	>0,95	295	595	30
92025	40W	3240Lm	81Lm/W	160°	LED	>0,95	295	1195	30
92026	40W	3240Lm	81Lm/W	160°	LED	>0,95	595	595	30
92027	48W	3888Lm	81Lm/W	160°	LED	>0,95	595	595	30



SIVA ALTI BACKLIGHT LED PANEL
RECESSED MOUNTED BACKLIGHT
LED PANEL



ÜRÜN ÖZELLİKLERİ/PRODUCT SPECIFICATIONS

Ürün Tanımı	Siva Altı LED Panel	Product Descripton	Recessed Mounted LED Panel
Gövde	DKP Sac	Body	DKP Sheet
Boya	Elektrostatik Toz Boya	Paint	Electrostatic Powder Coated
PCB	Yüksek Geçirgenliğe Sahip Alüminyum PCB	PCB	High Transmittance Aluminum PCB
Lens		Lens	
Reflektör		Reflector	
Difüzör	Opal Difüzör	Diffuser	High Transmittance Opal Diffuser
SDCM (MacAdam)	3	SDCM (MacAdam)	3
Renk Sıcaklığı	2700K-6500K	Colour Temperature	2700K-6500K
Ömür	50000h	Life Time	50000h
Çalışma Sıcaklığı	-20° ~ +50°C	Operating Temperature	-20° ~ +50°C
LED	Osram/Nichia	LED	Osram/Nichia
Sürücü	Osram/Samsung	Driver	Osram/Samsung
Uygunluk	Osram/Philips/Tridonic	Conformity	Osram/Philips/Tridonic

Ürün Kodu Product Code	Güç Power	Çıkış Işık Akısı Lumen Output	Verimlilik Efficiency	Işık Açısı Beam Angle	Işık Kaynağı Light Source	CRI	Ø CUT (mm)	L (mm)	W (mm)	H (mm)
92013	12,8W	1532Lm	120Lm/W	160°	LED	>0,95	275*275	300	600	70
92014	18,2W	2306Lm	127Lm/W	160°	LED	>0,95	275*575	300	600	70
92015	25,6W	3064Lm	120Lm/W	160°	LED	>0,95	275*575	300	600	70
92016	24,6W	3264Lm	133Lm/W	160°	LED	>0,95	275*1175	300	1200	70
92017	37,8W	4763Lm	126Lm/W	160°	LED	>0,95	275*1175	300	1200	70
92018	24,6W	3264Lm	133Lm/W	160°	LED	>0,95	575*575	300	1200	70
92019	34,5W	4399Lm	128Lm/W	160°	LED	>0,95	575*575	595	595	70
92020	37,8W	4763Lm	126Lm/W	160°	LED	>0,95	575*575	595	595	70
92021	49,2W	6529Lm	133Lm/W	160°	LED	>0,95	575*1175	595	595	70
92022	69W	8832Lm	128Lm/W	160°	LED	>0,95	575*1175	595	595	70



SIVA ALTI BACKLIGHT LED PANEL
RECESSED MOUNTED BACKLIGHT
LED PANEL

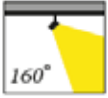

ÜRÜN ÖZELLİKLERİ/PRODUCT SPECIFICATIONS

Ürün Tanımı	Sıva Üstü Backlight LED Panel	Product Descripton	Surface Mounted Backlight LED Panel
Gövde	0,50mm DKP Sac	Body	0,50mm DKP Sheet
Boya	Elektrostatik Toz Boya	Paint	Electrostatic Powder Coated
PCB	Isı İletkenliği Yüksek PCB	PCB	High Conductive Heat -Resistance PCB
Lens		Lens	
Reflektör		Reflector	
Difüzör	Yüksek Geçirgenliğe Sahip Opal Difüzör	Diffuser	High Transmittance Opal Diffuser
SDCM (MacAdam)	3	SDCM (MacAdam)	3
Renk Sıcaklığı	2700K-6500K	Colour Temperature	2700K-6500K
Ömür	50000h	Life Time	50000h
Çalışma Sıcaklığı	-20° ~ +50°C	Operating Temperature	-20° ~ +50°C
LED	Osram/Nichia	LED	Osram/Nichia
Sürücü	Osram/Samsung	Driver	Osram/Samsung
Uygunluk	Osram/Philips/Tridonic	Conformity	Osram/Philips/Tridonic

Ürün Kodu Product Code	Güç Power	Çıkış Işık Akısı Lumen Output	Verimlilik Efficiency	Işık Açısı Beam Angle	Işık Kaynağı Light Source	CRI	L (mm)	W (mm)	H (mm)
93001	15W	1494Lm	100Lm/W	160°	LED	>0,95	300	300	70
93002	18W	1945Lm	108Lm/W	160°	LED	>0,95	300	600	70
93003	23W	2345Lm	102Lm/W	160°	LED	>0,95	300	600	70
93004	31W	3742Lm	120Lm/W	160°	LED	>0,95	300	1200	70
93005	40W	4105Lm	103Lm/W	160°	LED	>0,95	300	1200	70
93006	45W	4709Lm	105Lm/W	160°	LED	>0,95	300	1200	70
93007	31W	3609Lm	116Lm/W	160°	LED	>0,95	595	595	70
93008	34W	4054Lm	119Lm/W	160°	LED	>0,95	595	595	70
93009	40W	4402Lm	110Lm/W	160°	LED	>0,95	595	595	70
93010	44W	4968Lm	113Lm/W	160°	LED	>0,95	595	595	70
93011	63W	7772Lm	123Lm/W	160°	LED	>0,95	600	1200	70
93012	80W	9384Lm	117Lm/W	160°	LED	>0,95	600	1200	70



SIVA ALTI BACKLIGHT LED PANEL
RECESSED MOUNTED BACKLIGHT
LED PANEL



ÜRÜN ÖZELLİKLERİ/PRODUCT SPECIFICATIONS

Ürün Tanımı	Sıva Üstü Slim LED Panel	Product Descripton	Surface Mounted Slim LED Panel
Gövde	Alüminyum 0,25mm DKP Sac 1mm Alüminyum Extrüzyon Çerçeve	Body	Aluminum 0,25mm DKP Sheet 1mm Aluminum Extrusion Frame
Boya	Elektrostatik Toz Boya	Paint	Electrostatic Powder Coated
PCB	Isı İletkenliği Yüksek PCB	PCB	High Conductive Heat -Resistance PCB
Lens		Lens	
Reflektör		Reflector	High Transmittance Opal Diffuser
Difüzör	Yüksek Geçirgenliğe Sahip Polistiren Difüzör	Diffuser	High Transmittance Polystyrene Diffuser
SDCM (MacAdam)	3	SDCM (MacAdam)	3
Renk Sıcaklığı	2700K-6500K	Colour Temperature	2700K-6500K
Ömür	50000h	Life Time	50000h
Çalışma Sıcaklığı	-20° ~ +50°C	Operating Temperature	-20° ~ +50°C
LED	Osram/Samsung	LED	Osram/Samsung
Sürücü	Osram/Philips/Tridonic	Driver	Osram/Philips/Tridonic
Uygunluk	EN 60598-2-2	Conformity	EN 60598-2-2

Ürün Kodu Product Code	Güç Power	Çıkış Işık Akısı Lumen Output	Verimlilik Efficiency	Işık Açısı Beam Angle	Işık Kaynağı Light Source	CRI	L (mm)	W (mm)	H (mm)
93013	24W	1944Lm	81Lm/W	160°	LED	>0,95	300	300	40
93014	30W	2430Lm	81Lm/W	160°	LED	>0,95	300	600	40
93015	40W	3240Lm	81Lm/W	160°	LED	>0,95	300	1200	40
93016	40W	3240Lm	81Lm/W	160°	LED	>0,95	595	595	40
93017	48W	3888Lm	81Lm/W	160°	LED	>0,95	595	595	40



SIVA ALTI BACKLIGHT LED PANEL
RECESSED MOUNTED BACKLIGHT
LED PANEL

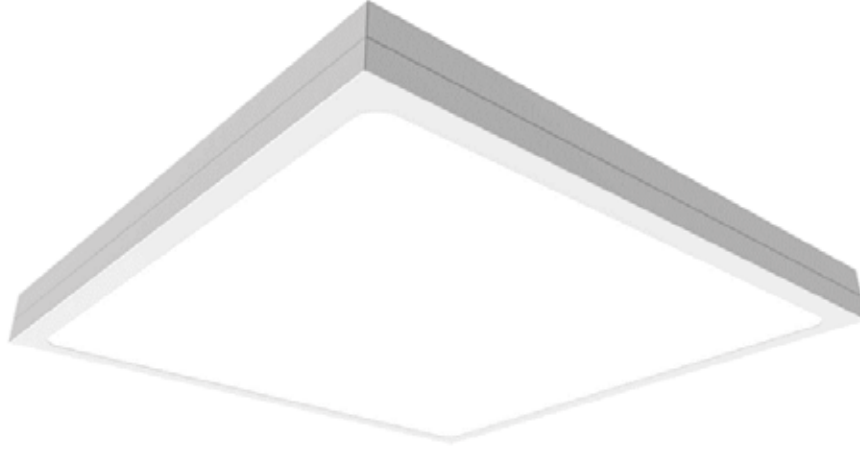

ÜRÜN ÖZELLİKLERİ/PRODUCT SPECIFICATIONS

Ürün Tanımı	Siva Üstü LED Panel	Product Descripton	Surface Mounted LED Panel
Gövde	DKP Sac	Body	DKP Sheet
Boya	Elektrostatik Toz Boya	Paint	Electrostatic Powder Coated
PCB	Yüksek Geçirgenliğe Sahip Alüminyum PCB	PCB	High Transmittance Aluminum PCB
Lens		Lens	
Reflektör		Reflector	
Difüzör	Opal Difüzör	Diffuser	High Transmittance Opal Diffuser
SDCM (MacAdam)	3	SDCM (MacAdam)	3
Renk Sıcaklığı	2700K-6500K	Colour Temperature	2700K-6500K
Ömür	50000h	Life Time	50000h
Çalışma Sıcaklığı	-20° ~ +50°C	Operating Temperature	-20° ~ +50°C
LED	Osram/Nichia	LED	Osram/Nichia
Sürücü	Osram/Samsung	Driver	Osram/Samsung
Uygunluk	Osram/Philips/Tridonic	Conformity	Osram/Philips/Tridonic

Ürün Kodu Product Code	Güç Power	Çıkış Işık Akısı Lumen Output	Verimlilik Efficiency	Işık Açısı Beam Angle	Işık Kaynağı Light Source	CRI	Ø CUT (mm)	L (mm)	W (mm)	H (mm)
93022	12,8W	1532Lm	120Lm/W	160°	LED	>0,95	275*275	300	300	70
93023	18,2W	2306Lm	127Lm/W	160°	LED	>0,95	275*575	300	600	70
93024	25,6W	3064Lm	120Lm/W	160°	LED	>0,95	275*575	300	600	70
93025	24,6W	3264Lm	133Lm/W	160°	LED	>0,95	275*1175	300	1200	70
93026	37,8W	4763Lm	126Lm/W	160°	LED	>0,95	275*1175	300	1200	70
93027	24,6W	3264Lm	133Lm/W	160°	LED	>0,95	575*575	600	600	70
93028	34,5W	4399Lm	128Lm/W	160°	LED	>0,95	575*575	600	600	70
93029	37,8W	4763Lm	126Lm/W	160°	LED	>0,95	575*575	600	600	70
93030	49,2W	6529Lm	133Lm/W	160°	LED	>0,95	575*1175	595	1200	70
93031	69W	8832Lm	128Lm/W	160°	LED	>0,95	575*1175	595	1200	70



**SIVA ALTI BACKLIGHT LED PANEL
RECESSED MOUNTED BACKLIGHT
LED PANEL**



ÜRÜN ÖZELLİKLERİ/PRODUCT SPECIFICATIONS

Ürün Tanımı	Alçıpan Backlight LED Panel	Product Description	Drywall Backlight LED Panel
Gövde	0,50mm DKP Sac 0,50mm DKP Saç Çerçeve	Body	0,50mm DKP Sheet 0,50mm DKP Sheet Frame
Boya	Elektrostatik Toz Boya	Paint	Electrostatic Powder Coated
PCB		PCB	
Lens		Lens	
Reflektör		Reflector	High Transmittance Opal Diffuser
Difüzör	Yüksek Geçirgenliğe Sahip Opal Difüzör	Diffuser	High Transmittance Opal Diffuser
SDCM (MacAdam)	3	SDCM (MacAdam)	3
Renk Sıcaklığı	2700K-6500K	Colour Temperature	2700K-6500K
Ömür	50000h	Life Time	50000h
Çalışma Sıcaklığı	-20° ~ +50°C	Operating Temperature	-20° ~ +50°C
LED	Osram/Samsung	LED	Osram/Samsung
Sürücü	Osram/Philips/Tridonic	Driver	Osram/Philips/Tridonic
Uygunluk	EN 60598-2-2	Conformity	EN 60598-2-2

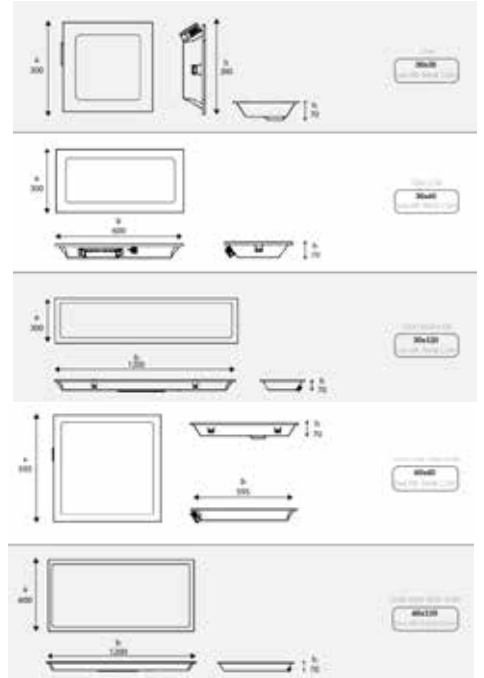

Ürün Kodu Product Code	Güç Power	Çıkış Işık Akısı Lumen Output	Verimlilik Efficiency	Işık Açısı Beam Angle	Işık Kaynağı Light Source	CRI	L (mm)	W (mm)	H (mm)
92033	15W	1494Lm	100Lm/W	160°	LED	>0,95	300	300	70
92034	18W	1945Lm	108Lm/W	160°	LED	>0,95	300	600	70
92035	23W	2345Lm	102Lm/W	160°	LED	>0,95	300	600	70
92036	31W	3742Lm	120Lm/W	160°	LED	>0,95	300	1200	70
92037	40W	4105Lm	103Lm/W	160°	LED	>0,95	300	1200	70
92038	45W	4709Lm	105Lm/W	160°	LED	>0,95	300	1200	70
92039	31W	3609Lm	116Lm/W	160°	LED	>0,95	595	595	70
92040	34W	4054Lm	119Lm/W	160°	LED	>0,95	595	595	70
92041	40W	4402Lm	110Lm/W	160°	LED	>0,95	595	595	70
92042	44W	4968Lm	113Lm/W	160°	LED	>0,95	595	595	70
92043	63W	7772Lm	123Lm/W	160°	LED	>0,95	600	1200	70
92044	80W	9384Lm	117Lm/W	160°	LED	>0,95	600	1200	70



SIVA ALTI BACKLIGHT LED PANEL
RECESSED MOUNTED BACKLIGHT
LED PANEL



ÜRÜN ÖZELLİKLERİ/PRODUCT SPECIFICATIONS

Ürün Tanımı	Alçıpan Slim LED Panel	Product Descripton	Drywall Slim LED Panel
Gövde	Alüminyum 0,25mm DKP Sac 1mm Alüminyum Extrüzyon Çerçeve	Body	Aluminum 0,25mm DKP Sheet 1mm Aluminum Extrusion Frame
Boya	Elektrostatik Toz Boya	Paint	Electrostatic Powder Coated
PCB		PCB	
Lens		Lens	
Reflektör		Reflector	High Transmittance Opal Diffuser
Diffüzör	Yüksek Geçirgenliğe Sahip Polistiren Diffüzör	Diffuser	High Transmittance Polystyrene Diffuser
SDCM (MacAdam)	3	SDCM (MacAdam)	3
Renk Sıcaklığı	2700K-6500K	Colour Temperature	2700K-6500K
Ömür	50000h	Life Time	50000h
Çalışma Sıcaklığı	-20° ~ +50°C	Operating Temperature	-20° ~ +50°C
LED	Osram/Samsung	LED	Osram/Samsung
Sürücü	Osram/Philips/Tridonic	Driver	Osram/Philips/Tridonic
Uygunluk	EN 60598-2-2	Conformity	EN 60598-2-2

Ürün Kodu Product Code	Güç Power	Çıkış Işık Akısı Lumen Output	Verimlilik Efficiency	Işık Açısı Beam Angle	Işık Kaynağı Light Source	CRI	L (mm)	W (mm)	H (mm)
92028	24W	1944Lm	81Lm/W	160°	LED	>0,95	295	295	30
92029	30W	2430Lm	81Lm/W	160°	LED	>0,95	295	595	30
92030	40W	3240Lm	81Lm/W	160°	LED	>0,95	295	1195	30
92031	40W	3240Lm	81Lm/W	160°	LED	>0,95	595	595	30
92032	48W	3888Lm	81Lm/W	160°	LED	>0,95	595	595	30



SIVA ALTI BACKLIGHT LED PANEL
RECESSED MOUNTED BACKLIGHT
LED PANEL



ÜRÜN ÖZELLİKLERİ/PRODUCT SPECIFICATIONS

Ürün Tanımı	Alçıpan Backlight LED Panel	Product Description	Drywall Backlight LED Panel
Gövde	Alüminyum Çerçeve 0,25mm DKP Sac	Body	Aluminium Frame 0,25mm DKP Sheet
Boya	Elektrostatik Toz Boya	Paint	Electrostatic Powder Coated
PCB		PCB	
Lens		Lens	
Reflektör		Reflector	
Difüzör	Polistiren Difüzör	Diffuser	High Transmittance Opal Diffuser
SDCM (MacAdam)	3	SDCM (MacAdam)	3
Renk Sıcaklığı	2700K-6500K	Colour Temperature	2700K-6500K
Ömür	50000h	Life Time	50000h
Çalışma Sıcaklığı	-20° ~ +50°C	Operating Temperature	-20° ~ +50°C
LED	Osram/Nichia	LED	Osram/Nichia
Sürücü	Osram/Samsung	Driver	Osram/Samsung
Uygunluk	Osram/Philips/Tridonic	Conformity	Osram/Philips/Tridonic

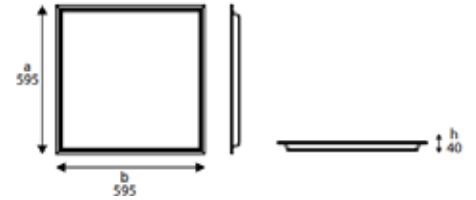

Ürün Kodu Product Code	Güç Power	Çıkış Işık Akısı Lumen Output	Verimlilik Efficiency	Işık Açısı Beam Angle	Işık Kaynağı Light Source	CRI	L (mm)	W (mm)	H (mm)
92045	34W	3316Lm	97Lm/W	160°	LED	>0,95	596	596	40
92046	40W	3772Lm	95Lm/W	160°	LED	>0,95	596	596	40



**SIVA ALTI BACKLIGHT LED PANEL
RECESSED MOUNTED BACKLIGHT
LED PANEL**

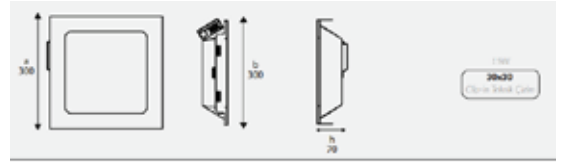
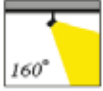

ÜRÜN ÖZELLİKLERİ/PRODUCT SPECIFICATIONS

Ürün Tanımı	Siva Altı Backlight Clip-in Panel	Product Description	Recessed Mounted Backlight Clip-in Panel
Gövde	0,50mm DKP Sac	Body	0,50mm DKP Sheet
Boya	0,50mm DKP Saç Çerçeve	Paint	0,50mm DKP Sheet Frame
PCB	Elektrostatik Toz Boya	PCB	Electrostatic Powder Coated
Lens		Lens	
Reflektör		Reflector	High Transmittance Opal Diffuser
Difüzör	Yüksek Geçirgenliğe Sahip Opal Difüzör	Diffuser	High Transmittance Opal Diffuser
SDCM (MacAdam)	3	SDCM (MacAdam)	3
Renk Sıcaklığı	2700K-6500K	Colour Temperature	2700K-6500K
Ömür	50000h	Life Time	50000h
Çalışma Sıcaklığı	-20° ~ +50°C	Operating Temperature	-20° ~ +50°C
LED	Osram/Samsung	LED	Osram/Samsung
Sürücü	Osram/Philips/Tridonic	Driver	Osram/Philips/Tridonic
Uygunluk	EN 60598-2-2	Conformity	EN 60598-2-2

Ürün Kodu Product Code	Güç Power	Çıkış Işık Akısı Lumen Output	Verimlilik Efficiency	Işık Açısı Beam Angle	Işık Kaynağı Light Source	CRI	L (mm)	W (mm)	H (mm)
92049	15W	1494Lm	100Lm/W	160°	LED	>0,95	300	300	70
92050	18W	1945Lm	108Lm/W	160°	LED	>0,95	300	600	70
92051	23W	2345Lm	102Lm/W	160°	LED	>0,95	300	600	70
92052	31W	3742Lm	120Lm/W	160°	LED	>0,95	300	1200	70
92053	40W	4105Lm	103Lm/W	160°	LED	>0,95	300	1200	70
92054	45W	4709Lm	105Lm/W	160°	LED	>0,95	300	1200	70
92055	31W	3609Lm	116Lm/W	160°	LED	>0,95	595	595	70
92056	34W	4054Lm	119Lm/W	160°	LED	>0,95	595	595	70
92057	40W	4402Lm	110Lm/W	160°	LED	>0,95	595	595	70
92058	44W	4968Lm	113Lm/W	160°	LED	>0,95	595	595	70
92059	63W	7772Lm	123Lm/W	160°	LED	>0,95	600	1200	70
92060	80W	9384Lm	117Lm/W	160°	LED	>0,95	600	1200	70



SIVA ALTI BACKLIGHT LED PANEL
RECESSED MOUNTED BACKLIGHT
LED PANEL



ÜRÜN ÖZELLİKLERİ/PRODUCT SPECIFICATIONS

Ürün Tanımı	Siva Altı Backlight Clip-in Panel	Product Descripton	Recessed Mounted Backlight Clip-in Panel
Gövde	Alüminyum 0,25mm DKP Sac 1mm Alüminyum Extrüzyon Çerçeve	Body	Aluminum 0,25mm DKP Sheet 1mm Aluminum Extrusion Frame
Boya	Elektrostatik Toz Boya	Paint	Electrostatic Powder Coated
PCB		PCB	
Lens		Lens	
Reflektör		Reflector	High Transmittance Opal Diffuser
Difüzör	Polistiren Difüzör	Diffuser	Polystyrene Diffuser
SDCM (MacAdam)	3	SDCM (MacAdam)	3
Renk Sıcaklığı	2700K-6500K	Colour Temperature	2700K-6500K
Ömür	50000h	Life Time	50000h
Çalışma Sıcaklığı	-20° ~ +50°C	Operating Temperature	-20° ~ +50°C
LED	Osram/Samsung	LED	Osram/Samsung
Sürücü	Osram/Philips/Tridonic	Driver	Osram/Philips/Tridonic
Uygunluk	EN 60598-2-2	Conformity	EN 60598-2-2

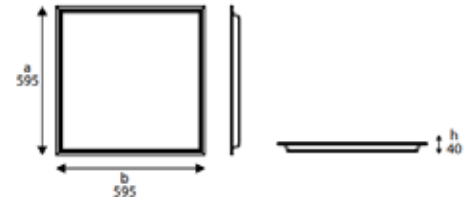

Ürün Kodu Product Code	Güç Power	Çıkış Işık Akısı Lumen Output	Verimlilik Efficiency	Işık Açısı Beam Angle	Işık Kaynağı Light Source	CRI	L (mm)	W (mm)	H (mm)
92061	34W	3316Lm	97Lm/W	160°	LED	>0,95	596	596	40
92062	40W	3772Lm	95Lm/W	160°	LED	>0,95	596	596	40



SIVA ALTI BACKLIGHT LED PANEL
RECESSED MOUNTED BACKLIGHT
LED PANEL



ÜRÜN ÖZELLİKLERİ/PRODUCT SPECIFICATIONS

Ürün Tanımı	Sıva Altı Clip-in Slim LED Panel	Product Description	Recessed Mounted Clip-in Slim LED Panel
Gövde	Alüminyum 0,25mm DKP Sac 1mm Alüminyum Extrüzyon Çerçeve	Body	Aluminum 0,25mm DKP Sheet 1mm Aluminum Extrusion Frame
Boya	Elektrostatik Toz Boya	Paint	Electrostatic Powder Coated
PCB		PCB	
Lens		Lens	
Reflektör		Reflector	High Transmittance Opal Diffuser
Difüzör	Yüksek Geçirgenliğe Sahip Polistiren Difüzör	Diffuser	High Transmittance Polystyrene Diffuser
SDCM (MacAdam)	3	SDCM (MacAdam)	3
Renk Sıcaklığı	2700K-6500K	Colour Temperature	2700K-6500K
Ömür	50000h	Life Time	50000h
Çalışma Sıcaklığı	-20° ~ +50°C	Operating Temperature	-20° ~ +50°C
LED	Osram/Samsung	LED	Osram/Samsung
Sürücü	Osram/Philips/Tridonic	Driver	Osram/Philips/Tridonic
Uygunluk	EN 60598-2-2	Conformity	EN 60598-2-2

Ürün Kodu Product Code	Güç Power	Çıkış Işık Akısı Lumen Output	Verimlilik Efficiency	Işık Açısı Beam Angle	Işık Kaynağı Light Source	CRI	L (mm)	W (mm)	H (mm)
92063	24W	1944Lm	81Lm/W	160°	LED	>0,95	300	300	20
92064	30W	2430Lm	81Lm/W	160°	LED	>0,95	300	300	20
92065	40W	3240Lm	81Lm/W	160°	LED	>0,95	300	1200	20
92066	40W	3240Lm	81Lm/W	160°	LED	>0,95	600	600	20
92067	48W	3888Lm	81Lm/W	160°	LED	>0,95	600	600	20



SIVA ALTI BACKLIGHT LED PANEL
RECESSED MOUNTED BACKLIGHT
LED PANEL



ÜRÜN ÖZELLİKLERİ/PRODUCT SPECIFICATIONS

Ürün Tanımı	Sıva Altı Clip-In LED Panel	Product Description	Recessed Mounted Clip-in LED Panel
Gövde	DKP Sac	Body	DKP Sheet
Boya	Elektrostatik Toz Boya	Paint	Electrostatic Powder Coated
PCB	Yüksek Geçirgenliğe Sahip Alüminyum PCB	PCB	High Transmittance Aluminum PCB
Lens		Lens	
Reflektör		Reflector	
Difüzör	Opal Difüzör	Diffuser	High Transmittance Opal Diffuser
SDCM (MacAdam)	3	SDCM (MacAdam)	3
Renk Sıcaklığı	2700K-6500K	Colour Temperature	2700K-6500K
Ömür	50000h	Life Time	50000h
Çalışma Sıcaklığı	-20° ~ +50°C	Operating Temperature	-20° ~ +50°C
LED	Osram/Nichia	LED	Osram/Nichia
Sürücü	Osram/Samsung	Driver	Osram/Samsung
Uygunluk	Osram/Philips/Tridonic	Conformity	Osram/Philips/Tridonic

Ürün Kodu Product Code	Güç Power	Çıkış Işık Akısı Lumen Output	Verimlilik Efficiency	Işık Açısı Beam Angle	Işık Kaynağı Light Source	CRI	L (mm)	W (mm)	H (mm)
92068	12,8W	1532Lm	120Lm/W	160°	LED	>0,95	295	295	70
92069	18,2W	2306Lm	127Lm/W	160°	LED	>0,95	295	595	70
92070	25,6W	3064Lm	120Lm/W	160°	LED	>0,95	295	595	70
92071	24,6W	3264Lm	133Lm/W	160°	LED	>0,95	295	1195	70
92072	37,8W	4763Lm	126Lm/W	160°	LED	>0,95	295	1195	70
92073	24,6W	3264Lm	133Lm/W	160°	LED	>0,95	595	595	70
92074	34,5W	4399Lm	128Lm/W	160°	LED	>0,95	595	595	70
92075	37,8W	4763Lm	126Lm/W	160°	LED	>0,95	595	595	70
92076	49,2W	6529Lm	133Lm/W	160°	LED	>0,95	595	1195	70
92077	69W	8832Lm	128Lm/W	160°	LED	>0,95	595	1195	70



SIVA ALTI LED PANEL/RECESSED MOUNTED LED PANEL



ÜRÜN ÖZELLİKLERİ/PRODUCT SPECIFICATIONS

Ürün Tanımı	Sıva Altı LED Panel	Product Description	Recessed Mounted LED Panel
Gövde	DKP Sac	Body	DKP Sheet
Boya	Elektrostatik Toz Boya	Paint	Electrostatic Powder Coated
PCB	Isı İletkenliği Yüksek PCB	PCB	High Heat Conductive PCB
Lens		Lens	
Reflektör		Reflector	
Difüzör	Opal Difüzör	Diffuser	High Transmittance Opal Diffuser
SDCM (MacAdam)	3	SDCM (MacAdam)	3
Renk Sıcaklığı	2700K-6500K	Colour Temperature	2700K-6500K
Ömür	50000h	Life Time	50000h
Çalışma Sıcaklığı	-20° ~ +50°C	Operating Temperature	-20° ~ +50°C
LED	Osram/Nichia	LED	Osram/Nichia
Sürücü	Osram/Samsung	Driver	Osram/Samsung
Uygunluk	Osram/Philips/Tridonic	Conformity	Osram/Philips/Tridonic



Ürün Kodu Product Code	Güç Power	Çıkış Işık Akısı Lumen Output	Verimlilik Efficiency	Işık Açısı Beam Angle	Işık Kaynağı Light Source	CRI	L (mm)	W (mm)	H (mm)
92089	9W	1008Lm	112Lm/W	160°	LED	>0,95	295	295	45
92090	18W	2052Lm	114Lm/W	160°	LED	>0,95	295	595	45
92091	37W	4255Lm	115Lm/W	160°	LED	>0,95	295	1195	45
92092	37W	4181Lm	113Lm/W	160°	LED	>0,95	595	595	45
92093	52W	5772Lm	111Lm/W	160°	LED	>0,95	595	1195	45



SIVA ALTI ALÇIPAN LED PANEL
RECESSED MOUNTED DRYWALL
LED PANEL

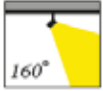

ÜRÜN ÖZELLİKLERİ/PRODUCT SPECIFICATIONS

Ürün Tanımı	Sıva Altı Alçıpan LED Panel	Product Description	Recessed Mounted Drywall LED Panel
Gövde	DKP Sac	Body	DKP Sheet
Boya	Elektrostatik Toz Boya	Paint	Electrostatic Powder Coated
PCB	Yüksek Geçirgenliğe Sahip Alüminyum PCB	PCB	High Transmittance Aluminum PCB
Lens		Lens	
Reflektör		Reflector	
Difüzör	Opal Difüzör	Diffuser	High Transmittance Opal Diffuser
SDCM (MacAdam)	3	SDCM (MacAdam)	3
Renk Sıcaklığı	2700K-6500K	Colour Temperature	2700K-6500K
Ömür	50000h	Life Time	50000h
Çalışma Sıcaklığı	-20° ~ +50°C	Operating Temperature	-20° ~ +50°C
LED	Osram/Nichia	LED	Osram/Nichia
Sürücü	Osram/Samsung	Driver	Osram/Samsung
Uygunluk	Osram/Philips/Tridonic	Conformity	Osram/Philips/Tridonic



Ürün Kodu Product Code	Güç Power	Çıkış Işık Akısı Lumen Output	Verimlilik Efficiency	Işık Açısı Beam Angle	Işık Kaynağı Light Source	CRI	Ø CUT (mm)	L (mm)	W (mm)	H (mm)
92094	9W	1008Lm	112Lm/W	160°	LED	>0,95	275*275	295	295	45
92095	18W	2052Lm	114Lm/W	160°	LED	>0,95	275*575	295	595	45
92096	37W	4255Lm	115Lm/W	160°	LED	>0,95	275*1175	295	1195	45
92097	37W	4181Lm	113Lm/W	160°	LED	>0,95	575*575	595	595	45
92098	52W	5772Lm	111Lm/W	160°	LED	>0,95	575*1175	595	1195	45



SIVA ALTI BACKLIGHT LED PANEL
RECESSED MOUNTED BACKLIGHT
LED PANEL

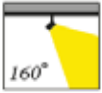

ÜRÜN ÖZELLİKLERİ/PRODUCT SPECIFICATIONS

Ürün Tanımı	Sıva Altı Clip-In LED Panel	Product Description	Recessed Mounted Clip-in LED Panel
Gövde	DKP Sac	Body	DKP Sheet
Boya	Elektrostatik Toz Boya	Paint	Electrostatic Powder Coated
PCB	Yüksek Geçirgenliğe Sahip Alüminyum PCB	PCB	High Transmittance Aluminum PCB
Lens		Lens	
Reflektör		Reflector	
Difüzör	Opal Difüzör	Diffuser	High Transmittance Opal Diffuser
SDCM (MacAdam)	3	SDCM (MacAdam)	3
Renk Sıcaklığı	2700K-6500K	Colour Temperature	2700K-6500K
Ömür	50000h	Life Time	50000h
Çalışma Sıcaklığı	-20° ~ +50°C	Operating Temperature	-20° ~ +50°C
LED	Osram/Nichia	LED	Osram/Nichia
Sürücü	Osram/Samsung	Driver	Osram/Samsung
Uygunluk	Osram/Philips/Tridonic	Conformity	Osram/Philips/Tridonic



Ürün Kodu Product Code	Güç Power	Çıkış Işık Akısı Lumen Output	Verimlilik Efficiency	Işık Açısı Beam Angle	Işık Kaynağı Light Source	CRI	L (mm)	W (mm)	H (mm)
92099	9W	1008Lm	112Lm/W	160°	LED	>0,95	300	300	45
92100	18W	2052Lm	114Lm/W	160°	LED	>0,95	300	600	45
92101	37W	4255Lm	115Lm/W	160°	LED	>0,95	300	1200	45
92102	37W	4181Lm	113Lm/W	160°	LED	>0,95	600	600	45
92103	52W	5772Lm	111Lm/W	160°	LED	>0,95	600	1200	45



SIVA ALTI LED PANEL/RECESSED MOUNTED LED PANEL



ÜRÜN ÖZELLİKLERİ/PRODUCT SPECIFICATIONS

Ürün Tanımı	Sıva Altı LED Panel	Product Description	Recessed Mounted LED Panel
Gövde	DKP Sac	Body	DKP Sheet
Boya	Elektrostatik Toz Boya	Paint	Electrostatic Powder Coated
PCB	Isı İletkenliği Yüksek PCB	PCB	High Heat Conductive PCB
Lens		Lens	
Reflektör	Yüksek Geçirgenliğe Sahip UGR: <19 Reflektör Lens	Reflector	High Efficient High Transmittance Opal Diffuser
SDCM (MacAdam)	3	SDCM (MacAdam)	3
Renk Sıcaklığı	2700K-6500K	Colour Temperature	2700K-6500K
Ömür	50000h	Life Time	50000h
Çalışma Sıcaklığı	-20° ~ +50°C	Operating Temperature	-20° ~ +50°C
LED	Osram/Nichia	LED	Osram/Nichia
Sürücü	Osram/Samsung	Driver	Osram/Samsung
Uygunluk	Osram/Philips/Tridonic	Conformity	Osram/Philips/Tridonic

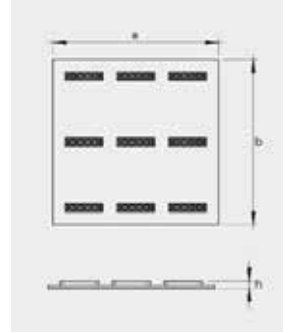

Ürün Kodu Product Code	Güç Power	Çıkış Işık Akısı Lumen Output	Verimlilik Efficiency	Işık Açısı Beam Angle	Işık Kaynağı Light Source	CRI	L (mm)	W (mm)	H (mm)
92104	15W	1875Lm	125Lm/W	160°	LED	>0,95	295	295	25
92105	23W	2898Lm	126Lm/W	160°	LED	>0,95	295	595	25
92106	40W	4960Lm	124Lm/W	160°	LED	>0,95	295	1195	25
92107	45W	5535Lm	123Lm/W	160°	LED	>0,95	295	1195	25
92108	34W	4248Lm	126Lm/W	160°	LED	>0,95	595	595	25
92109	40W	5005Lm	125Lm/W	160°	LED	>0,95	595	595	25
92110	44W	5456Lm	124Lm/W	160°	LED	>0,95	595	595	25
92111	63W	7560Lm	120Lm/W	160°	LED	>0,95	595	1195	25
92112	80W	9440Lm	118Lm/W	160°	LED	>0,95	595	1195	25



SIVA ALTI BACKLIGHT LED PANEL
RECESSED MOUNTED BACKLIGHT
LED PANEL



ÜRÜN ÖZELLİKLERİ/PRODUCT SPECIFICATIONS

Ürün Tanımı	Sıva Altı Clip-In LED Panel	Product Description	Recessed Mounted Clip-in LED Panel
Gövde	DKP Sac	Body	DKP Sheet
Boya	Elektrostatik Toz Boya	Paint	Electrostatic Powder Coated
PCB	Yüksek Geçirgenliğe Sahip Alüminyum PCB	PCB	High Transmittance Aluminum PCB
Lens		Lens	
Reflektör	Yüksek Geçirgenliğe Sahip	Reflector	High Efficient
Difüzör	UGR: <19 Reflektör Lens	Difüzer	High Transmittance Opal Diffuser
SDCM (MacAdam)	3	SDCM (MacAdam)	3
Renk Sıcaklığı	2700K-6500K	Colour Temperature	2700K-6500K
Ömür	50000h	Life Time	50000h
Çalışma Sıcaklığı	-20° ~ +50°C	Operating Temperature	-20° ~ +50°C
LED	Osram/Nichia	LED	Osram/Nichia
Sürücü	Osram/Samsung	Driver	Osram/Samsung
Uygunluk	Osram/Philips/Tridonic	Conformity	Osram/Philips/Tridonic



Ürün Kodu Product Code	Güç Power	Çıkış Işık Akısı Lumen Output	Verimlilik Efficiency	Işık Açısı Beam Angle	Işık Kaynağı Light Source	CRI	L (mm)	W (mm)	H (mm)
92113	15W	1875Lm	125Lm/W	160°	LED	>0,95	300	300	25
92114	23W	2898Lm	126Lm/W	160°	LED	>0,95	300	600	25
92115	40W	4960Lm	124Lm/W	160°	LED	>0,95	300	1200	25
92116	45W	5535Lm	123Lm/W	160°	LED	>0,95	300	1200	25
92117	34W	4248Lm	126Lm/W	160°	LED	>0,95	600	600	25
92118	40W	5005Lm	125Lm/W	160°	LED	>0,95	600	600	25
92119	44W	5456Lm	124Lm/W	160°	LED	>0,95	600	600	25
92120	63W	7560Lm	120Lm/W	160°	LED	>0,95	600	1200	25
92121	80W	9440Lm	118Lm/W	160°	LED	>0,95	600	1200	25



SIVA ALTI ALÇIPAN LED PANEL
RECESSED MOUNTED DRYWALL
LED PANEL

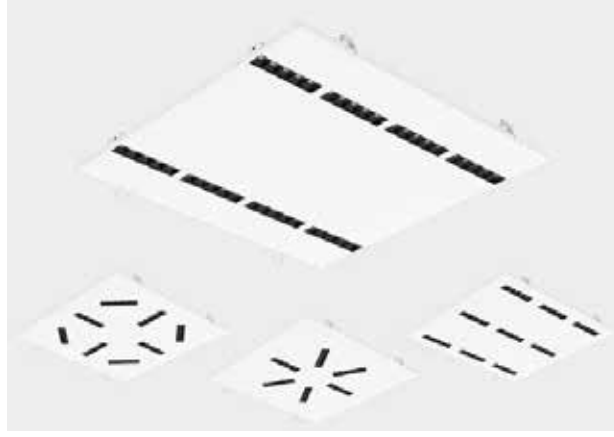

ÜRÜN ÖZELLİKLERİ/PRODUCT SPECIFICATIONS

Ürün Tanımı	Sıva Altı Alçıpan LED Panel	Product Description	Recessed Mounted Drywall LED Panel
Gövde	DKP Sac	Body	DKP Sheet
Boya	Elektrostatik Toz Boya	Paint	Electrostatic Powder Coated
PCB	Yüksek Geçirgenliğe Sahip Alüminyum PCB	PCB	High Transmittance Aluminum PCB
Lens		Lens	
Reflektör	Yüksek Geçirgenliğe Sahip UGR: <19 Reflektör Lens	Reflector	High Efficient High Transmittance Opal Diffuser
SDCM (MacAdam)	3	SDCM (MacAdam)	3
Renk Sıcaklığı	2700K-6500K	Colour Temperature	2700K-6500K
Ömür	50000h	Life Time	50000h
Çalışma Sıcaklığı	-20° ~ +50°C	Operating Temperature	-20° ~ +50°C
LED	Osram/Nichia	LED	Osram/Nichia
Sürücü	Osram/Samsung	Driver	Osram/Samsung
Uygunluk	Osram/Philips/Tridonic	Conformity	Osram/Philips/Tridonic

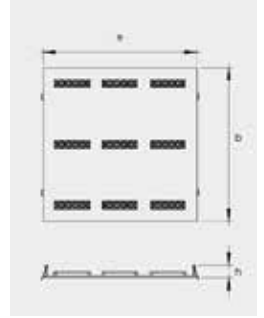

Ürün Kodu Product Code	Güç Power	Çıkış Işık Akısı Lumen Output	Verimlilik Efficiency	Işık Açısı Beam Angle	Işık Kaynağı Light Source	CRI	Ø CUT (mm)	L (mm)	W (mm)	H (mm)
92122	15W	1875Lm	125Lm/W	160°	LED	>0,95	275*275	295	295	25
92123	23W	2898Lm	126Lm/W	160°	LED	>0,95	275*575	295	595	25
92124	40W	4960Lm	124Lm/W	160°	LED	>0,95	275*1175	295	1195	25
92125	45W	5535Lm	123Lm/W	160°	LED	>0,95	275*1175	295	1195	25
92126	34W	4248Lm	126Lm/W	160°	LED	>0,95	575*575	595	595	25
92127	40W	5005Lm	125Lm/W		LED	>0,95	575*575	595	595	25
92128	44W	5456Lm	124Lm/W		LED	>0,95	575*575	595	595	25
92129	63W	7560Lm	120Lm/W		LED	>0,95	575*1175	595	1195	25
92130	80W	9440Lm	118Lm/W		LED	>0,95	575*1175	595	1195	25



SIVA ALTI BACKLIGHT LED PANEL
RECESSED MOUNTED BACKLIGHT
LED PANEL



1



2

X:MODEL SEÇİMİ
X:MODEL SELECTION

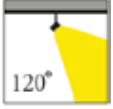

ÜRÜN ÖZELLİKLERİ/PRODUCT SPECIFICATIONS

Ürün Tanımı	Sıva Üstü Led Panel	Product Descripton	Surface Mounted Led Panel
Gövde	DKP Saç	Body	DKP Sheet Metal
Boya		Paint	
PCB	Isı İletkenliği Yüksek PCB	PCB	High Conductive Heat -Resistance PCB
Lens		Lens	
Reflektör		Reflector	
Difüzör	Opal	Diffuser	High Transmittance Opal Diffuser
SDCM (MacAdam)	3	SDCM (MacAdam)	3
Renk Sıcaklığı	2700K-6500K	Colour Temperature	2700K-6500K
Ömür	50000h	Life Time	50000h
Çalışma Sıcaklığı	0°C- +40°C	Operating Temperature	0°C- +40°C
LED	Osram/Nichia	LED	Osram/Nichia
Sürücü	Osram/Samsung	Driver	Osram/Samsung
Uygunluk	Osram/Philips/Tridonic	Conformity	Osram/Philips/Tridonic

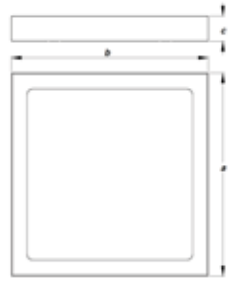

Ürün Kodu Product Code	Güç Power	Çıkış Işık Akısı Lumen Output	Verimlilik Efficiency	Işık Açısı Beam Angle	Işık Kaynağı Light Source	CRI	L (mm)	W (mm)	H (mm)
93018	25W	2996Lm	120Lm/W	120°	LED	>0,95	60	60	65
93019	32W	3765Lm	118Lm/W	120°	LED	>0,95	60	60	65
93020	38W	4346Lm	115Lm/W	120°	LED	>0,95	60	60	65
93021	52W	5594Lm	108Lm/W	120°	LED	>0,95	60	60	65



Etanj Endüstriyel



Etange Industrial

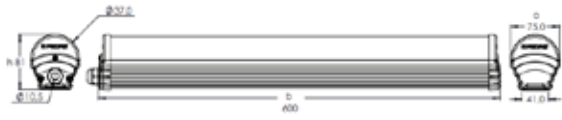

20W

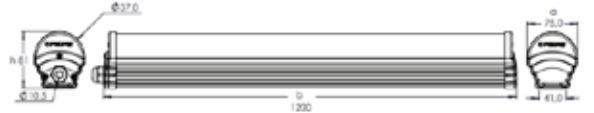

40W

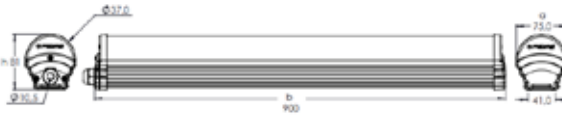

30W

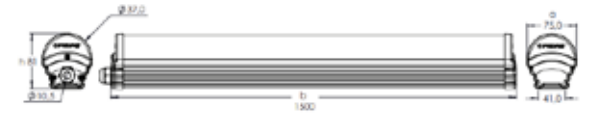

50W

ÜRÜN ÖZELLİKLERİ/PRODUCT SPECIFICATIONS

Ürün Tanımı	Sıva Üstü Etanj	Product Descripton	Surface Mounted Etange
Gövde	Polikarbon	Body	Polycarbonate
Boya / Kapak		Paint / Cap	
Diğer Özellik	Isı İletkenliği Yüksek Alüminyum PCB	Other	High Conductive Heat -Resistance Aluminum PCB
Lens		Lens	
Reflektör		Reflector	
Difüzör	Isı İletkenliği Yüksek PCB	Diffuser	High Conductive Heat -Resistance PCB
SDCM (MacAdam)	3	SDCM (MacAdam)	3
Renk Sıcaklığı	2700K-6500K	Colour Temperature	2700K-6500K
Ömür	50000h	Life Time	50000h
Çalışma Sıcaklığı	0°C- +40°C	Operating Temperature	0°C- +40°C
LED	Osram/Samsung	LED	Osram/Samsung
Sürücü		Driver	
Uygunluk	EN 60598-2-2	Conformity	EN 60598-2-2

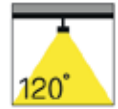

Ürün Kodu Product Code	Güç Power	Çıkış Işık Akısı Lumen Output	Verimlilik Efficiency	Işık Açısı Beam Angle	Işık Kaynağı Light Source	CRI	A (mm)	B (mm)	H (mm)
14001	20W	2300Lm	115Lm/W	120°	Power LED	80	75	600	81
14002	30W	3540Lm	118Lm/W	120°	Power LED	80	75	900	81
14003	40W	4600Lm	115Lm/W	120°	Power LED	80	75	1200	81
14004	50W	6000Lm	120Lm/W	120°	Power LED	80	75	1500	81
14005	60W	7200Lm	120Lm/W	120°	Power LED	80	75	1500	81





ÜRÜN ÖZELLİKLERİ/PRODUCT SPECIFICATIONS

Ürün Tanımı	Sıva Üstü Etanj	Product Descripton	Surface Mounted Etange
Gövde	Alüminyum Ekstrüzyon Silikon Enjeksiyon Conta	Body	Aluminum Extrusion Silicone Injection Gasket
Diğer Özellik	Isı İletkenliği Yüksek PCB	Other	High Conductive Heat -Resistance PCB
Lens	Polikarbon Optik	Lens	Polycarbonate Optic
Difüzör	Opal Difüzör	Diffuser	Opal Diffuser
SDCM (MacAdam)	3	SDCM (MacAdam)	3
Renk Sıcaklığı	2700K-6500K	Colour Temperature	2700K-6500K
Ömür	60000h	Life Time	60000h
Çalışma Sıcaklığı	0°C- +40°C	Operating Temperature	0°C- +40°C
LED	Osram/Samsung	LED	Osram/Samsung
Sürücü		Driver	
Uygunluk	EN 60598-2-2	Conformity	EN 60598-2-2
Opsiyonel	T8 Ampul Koridor Fonksiyonel	Optional	T8 Bulb Corridor Functional

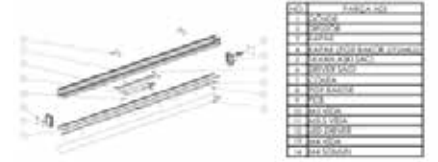
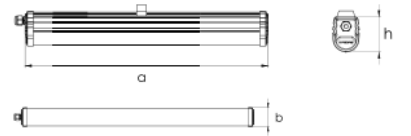
LED Aluminum Waterproof Luminaire
LED Alüminyum Etanj Armatürü

Ürün Kodu Product Code	Güç Power	Çıkış Işık Akısı Lumen Output	Verimlilik Efficiency	Işık Açısı Beam Angle	Işık Kaynağı Light Source	CRI	A (mm)	B (mm)	H (mm)
14151	10W	1160Lm	116Lm/W	120°	Power LED	80	320	52,1	91,8
14152	20W	2308Lm	115Lm/W	120°	Power LED	80	624	52,1	91,8
14153	30W	3541Lm	118Lm/W	120°	Power LED	80	935	52,1	91,8
14154	40W	4602Lm	115Lm/W	120°	Power LED	80	1220	52,1	91,8
14155	50W	5651Lm	113Lm/W	120°	Power LED	80	1527	52,1	91,8
14156	60W	6780Lm	113Lm/W	120°	Power LED	80	1527	52,1	91,8
14177	W	Lm			T8	80	1220	52,1	91,8



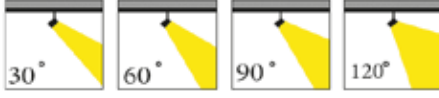

ÜRÜN ÖZELLİKLERİ/PRODUCT SPECIFICATIONS

Ürün Tanımı	Projektör	Product Descripton	Projector
Gövde	Elektrostatiktoz Boyalı Alüminyum Enjeksiyon Paslanmaz Çelik Civatalar,Silikon Conta	Body	Electrostatic Powder Coated Aluminum Injection Stainless Steel Screws,Silicone Gasket
Lens	Yüksek Geçirgenli Cam, PMMA Lens	Lens	Ultra Clear Glass, PMMA Lens
SDCM (MacAdam)	3	SDCM (MacAdam)	3
Renk Sıcaklığı	3000K/4000K/6500K	Colour Temperature	3000K/4000K/6500K
Ömür	50000h	Life Time	50000h
Çalışma Sıcaklığı	-25°C/+50°C	Operating Temperature	-25°C/+50°C
LED	Osram/Samsung	LED	Osram/Samsung
Sürücü	Philips/Tridonic	Driver	Philips/Tridonic
Uygunluk	TSEN60598 -2-2	Conformity	TSEN60598 -2-2

Ürün Kodu Product Code	Güç Power	Çıkış Işık Akısı Lumen Output	Verimlilik Efficiency	Işık Açısı Beam Angle	Işık Kaynağı Light Source	CRI	A (mm)	B (mm)	H (mm)
58113	102W	14383Lm	140Lm/W	30° / 60° / 90° / 120°	LED	+80	330,5	393	66
58114	150W	19787Lm	132Lm/W	30° / 60° / 90° / 120°	LED	+80	330,5	393	66



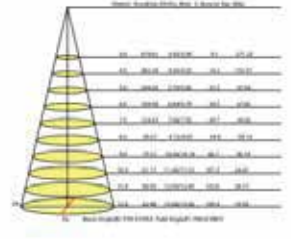
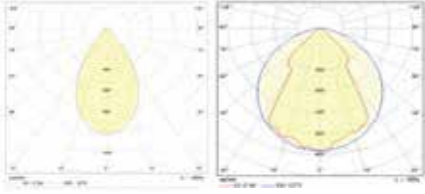
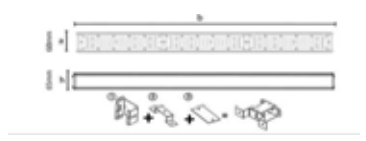
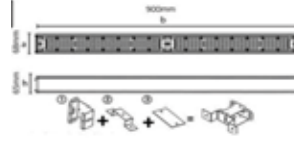
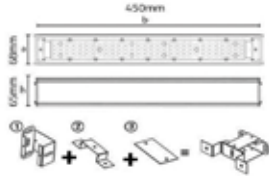

ÜRÜN ÖZELLİKLERİ/PRODUCT SPECIFICATIONS

Ürün Tanımı	Yüksek & Alçak Tavan Aydınlatma Armatür
Gövde	Alüminyum Enjeksiyon Termal İletken Madde 3M-Optic Yapıştırıcı
Difüzör	PMMA
SDCM (MacAdam)	3
Renk Sıcaklığı	2700K/3000K/4000K/6500K
Ömür	50000h
Çalışma Sıcaklığı	-25°C/+50°C
LED	Nichia
Uygunluk	EN60598-1:2009-04

Product Descripton	High & Low Bay Lighting Luminaire
Body	Die-Cast Aluminum Thermally Conductive by 3M-Optic Glue
Diffuser	PMMA
SDCM (MacAdam)	3
Colour Temperature	2700K/3000K/4000K/6500K
Life Time	50000h
Operating Temperature	-25°C/+50°C
LED	Nichia
Conformity	EN60598-1:2009-04



Ürün Kodu Product Code	Güç Power	Çıkış Işık Akısı Lumen Output	Verimlilik Efficiency	Işık Açısı Beam Angle	Işık Kaynağı Light Source	CRİ	A (mm)	B (mm)	C (mm)
69001	40W	6021Lm	150Lm/W	-	LED	+80	68	450	65
69002	60W	8411Lm	140Lm/W	-	LED	+80	68	450	65
69003	80W	11520Lm	144Lm/W	-	LED	+80	68	900	65
69004	110W	15412Lm	140Lm/W	-	LED	+80	68	900	65
69005	140W	19320Lm	138Lm/W	-	LED	+80	68	1310	65
69006	150W	20700Lm	138Lm/W	-	LED	+80	68	1310	65





ÜRÜN ÖZELLİKLERİ/PRODUCT SPECIFICATIONS

Ürün Tanımı	Sıva Üstü Lineer Armatür	Product Description	Surface Mounted Lineer Luminaire
Gövde	Alüminyum Ekstrüzyon Profil / DKP	Body	Aluminum Extrusion Profile/DKP
Boya / Kapak	Alüminyum Enjeksiyon	Paint / Cap	Aluminum Injection
Diğer Özellik		Other	
Lens		Lens	
Reflektör	Eloksal Reflektör	Reflector	Anodized Reflector
Difüzör	PCB	Diffuser	PCB
SDCM (MacAdam)	3	SDCM (MacAdam)	3
Renk Sıcaklığı	2700K/6500K	Colour Temperature	2700K/6500K
Ömür	50000h	Life Time	50000h
Çalışma Sıcaklığı	25°C	Operating Temperature	25°C
LED	Samsung	LED	Samsung
Sürücü	TRIDONIC / OSRAM / PHILIPS	Sürücü	TRIDONIC / OSRAM / PHILIPS
Uygunluk	EN 60598-1 EN 60598-2-1	Conformity	EN 60598-1 EN 60598-2-1



Ürün Kodu Product Code	Güç Power	Çıkış Işık Akısı Lumen Output	Verimlilik Efficiency	Işık Açısı Beam Angle	Işık Kaynağı Light Source	CRI	A (mm)	B (mm)	H (mm)
90175	50W	6250Lm	125Lm/W	90°	LED	80	646	152	63
90176	100W	12998Lm	130Lm/W	90°	LED	80	1246	152	63



Led Line



SOHO
Light Design

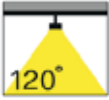

ÜRÜN ÖZELLİKLERİ/PRODUCT SPECIFICATIONS

Ürün Tanımı	Siva Üstü LED Line	Product Descripton	Surface Mounted LED Line
Gövde	Alüminyum Profil	Body	Aluminum Profile
	Montaj Aparatı/Dişi Erkek Soket		Mounting Apparatus/Female Male Socket
Led Sayısı Opsiyonel	60 LED/m - 120 LED/m	Number Of Leds	60 LED/m - 120 LED/m
Difüzör	PMMA/Şeffaf/Buzlu	Diffuser	PMMA/Transparent/Milky
Reflektör Opsiyonel	Renk Filtresi	Reflector Optional	Color Filter
SDCM (MacAdam)	3	SDCM (MacAdam)	3
Renk Sıcaklığı	2700K/3000K/4000K/5000K/6000K	Colour Temperature	2700K/3000K/4000K/5000K/6000K
Ömür	50000h	Life Time	50000h
Çalışma Sıcaklığı	25°C	Operating Temperature	25°C
LED	Osram/Samsung	LED	Osram/Samsung
Sürücü	Harıç	Driver	Excl.
Uygunluk	EN 60598-1 EN 60598-2-1	Conformity	EN 60598-1 EN 60598-2-1

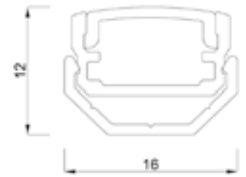

Ürün Kodu Product Code	Güç Power	Çıkış Işık Akısı Lumen Output	Verimlilik Efficiency	Işık Açısı Beam Angle	Işık Kaynağı Light Source	CRI OPT.	L (mm)	W (mm)	H (mm)
35002	14,4W/m	1440Lm	100Lm/W	120°	LED	>80 - >90	∞	16	12
35016	10W/m	1000Lm	100Lm/W	120°	LED	>80 - >90	∞	16	12
35014	18W/m	1800Lm	100Lm/W	120°	LED	>80 - >90	∞	16	12
35015	5W/m			120°	LED	>80 - >90	∞	16	12
35023	24W/m	2400Lm/m	100Lm/W	120°	LED	>80 - >90	∞	16	12



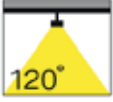

ÜRÜN ÖZELLİKLERİ/PRODUCT SPECIFICATIONS

Ürün Tanımı	Sıva Üstü LED Line	Product Description	Surface Mounted LED Line
Gövde	Alüminyum Eloksal	Body	Aluminum
Boya / Kapak	Alüminyum Enjeksiyon	Paint / Cap	Aluminum Injection
Diğer Özellik		Other	
Lens		Lens	
Reflektör		Reflector	
Difüzör	Polikarbon	Diffuser	Policarbonate
SDCM (MacAdam)	3	SDCM (MacAdam)	3
Renk Sıcaklığı	2700K/3000K/4000K	Colour Temperature	2700K/3000K/4000K
Ömür	50000h	Life Time	50000h
Çalışma Sıcaklığı	25°C	Operating Temperature	25°C
LED	Osram	LED	Osram
Sürücü		Driver	
Uygunluk	EN 60598-1	Conformity	EN 60598-1

Ürün Kodu Product Code	Güç Power	Çıkış Işık Akısı Lumen Output	Verimlilik Efficiency	Işık Açısı Beam Angle	Işık Kaynağı Light Source	CRI	L (mm)	W (mm)	H (mm)
35025	4,8W/m	400Lm/m	83Lm/W	120°	LED	80	∞	26	32
35026	9,6W/m	800Lm/m	83Lm/W	120°	LED	80	∞	26	32
35013	14,4W/m	1200Lm/m	83Lm/W	120°	LED	80	∞	26	32
35027	16,8W/m	1400Lm/m	83Lm/W	120°	LED	80	∞	26	32
35028	24W/m	2000Lm/m	83Lm/W	120°	LED	80	∞	26	32



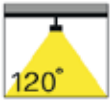

ÜRÜN ÖZELLİKLERİ/PRODUCT SPECIFICATIONS

Ürün Tanımı	Sıva Üstü LED Line	Product Descripton	Surface Mounted LED Line
Gövde	Alüminyum Profil	Body	Aluminum Profile
	Montaj Aparatı/Dişi Erkek Soket		Mounting Apparatus/Female Male Socket
Led Sayısı Opsiyonel	60 LED/m - 120 LED/m	Number Of Leds	60 LED/m - 120 LED/m
Difüzör	PMMA/Şeffaf/Buzlu	Diffuser	PMMA/Transparent/Milky
Reflektör Opsiyonel	Renk Filtresi	Reflector Optional	Color Filter
SDCM (MacAdam)	3	SDCM (MacAdam)	3
Renk Sıcaklığı	2700K/3000K/4000K/5000K/6000K	Colour Temperature	2700K/3000K/4000K/5000K/6000K
Ömür	50000h	Life Time	50000h
Çalışma Sıcaklığı	25°C	Operating Temperature	25°C
LED	Osram/Samsung	LED	Osram/Samsung
Sürücü	Hariç	Driver	Excl.
Uygunluk	EN 60598-1 EN 60598-2-1	Conformity	EN 60598-1 EN 60598-2-1

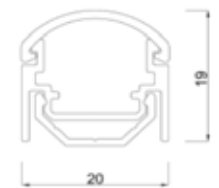

Ürün Kodu Product Code	Güç Power	Çıkış Işık Akısı Lumen Output	Verimlilik Efficiency	Işık Açısı Beam Angle	Işık Kaynağı Light Source	CRI OPT.	L (mm)	W (mm)	H (mm)
35018	5W/m	415Lm	83Lm/W	120°	LED	>80 - >90	∞	20	19
35019	10W/m	830Lm	83Lm/W	120°	LED	>80 - >90	∞	20	19
35020	14,4W/m	1200Lm/m	83Lm/W	120°	LED	>80 - >90	∞	20	19
35021	18W/m	1495Lm	83Lm/W	120°	LED	>80 - >90	∞	20	19
35022	24W/m	1990Lm/m	83Lm/W	120°	LED	>80 - >90	∞	20	19



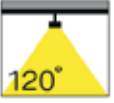

ÜRÜN ÖZELLİKLERİ/PRODUCT SPECIFICATIONS

Ürün Tanımı	Sıva Üstü LED Line	Product Description	Surface Mounted LED Line
Gövde	Alüminyum Profil	Body	Aluminum Profile
Led Sayısı Opsiyonel	60 LED/m - 120 LED/m	Number Of Leds	60 LED/m - 120 LED/m
Difüzör	PMMA/Şeffaf/Buzlu	Diffuser	PMMA/Transparent/Milky
Reflektör Opsiyonel	Renk Filtresi	Reflector Optional	Color Filter
SDCM (MacAdam)	3	SDCM (MacAdam)	3
Renk Sıcaklığı	2700K/3000K/4000K	Colour Temperature	2700K/3000K/4000K
Ömür	50000h	Life Time	50000h
Çalışma Sıcaklığı	25°C	Operating Temperature	25°C
LED	Osram/Samsung	LED	Osram/Samsung
Sürücü	Harış	Driver	Excl.
Uygunluk	EN 60598-1 EN 60598-2-1	Conformity	EN 60598-1 EN 60598-2-1

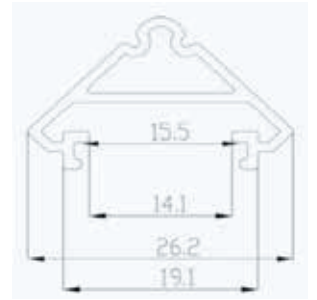

Ürün Kodu Product Code	Güç Power	Çıkış Işık Akısı Lumen Output	Verimlilik Efficiency	Işık Açısı Beam Angle	Işık Kaynağı Light Source	CRI OPT.	L (mm)	W (mm)	H (mm)
35043	5W/m	415Lm	83Lm/W	120°	LED	>80 - >90	∞	15,5	26,2
35044	10W/m	830Lm	83Lm/W	120°	LED	>80 - >90	∞	15,5	26,2
35045	14,4W/m	1200Lm/m	83Lm/W	120°	LED	>80 - >90	∞	15,5	26,2
35046	18W/m	1495Lm	83Lm/W	120°	LED	>80 - >90	∞	15,5	26,2
35047	24W/m	1990Lm/m	83Lm/W	120°	LED	>80 - >90	∞	15,5	26,2



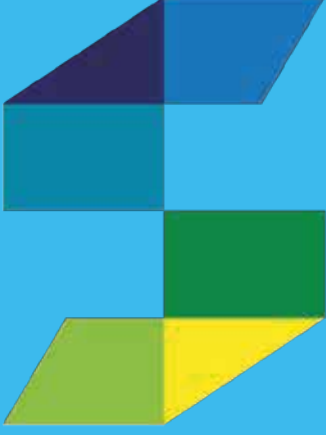

SOHO

Light Design

İSTANBUL MERKEZ OFİS::

Ferhatpaşa Mahallesi Üsküdar Caddesi Coşkun İş
Merkezi No:42/5 Ataşehir/İSTANBUL Küçükalyalı
V.D : 7720633902
Tel : +90 216 576 69 41
Fax: +90 216 576 69 42
info@soholight.com

AZERBAYCAN BAKU OFİS::

Badamdar ges Massiv 1 kuc. Ev
316 Bakü/AZERBAYCAN
TEL: +99 412 502 67 09
FAX: +99 412 502 67 09
baku@soholight.com