

EMERGENCY LIGHTING



2024



Görülebilir Mesafesi : 30m
Visibility Range:30m

Acil Durumda 3 Saat Yanabilir
Emergency Operation Time 3 Hours

Çift yönlü, sivaüstü montaj
Surface Mounted, Double Sided

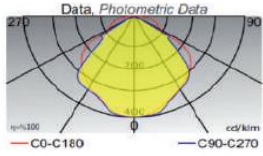

ÜRÜN ÖZELLİKLERİ/PRODUCT SPECIFICATIONS

| | |
|--------------------|--|
| Ürün Tanımı | Acil Durum Yönlendirme Armatürleri |
| Gövde | ABS Ekstrüzyon Gövde Enjeksiyon Akirlik Plexiglas |
| Çalışma Gerilimi | Standart Şekillerde Serigrafi Baskılı Etiket |
| Şarj Süresi | 220 - 230 V AC 50/60Hz ±%10 |
| Batarya Kapasitesi | 24h |
| Renk Sıcaklığı | 1.2V 1.1Ah |
| Pil | 6500K |
| Çalışma Sıcaklığı | Yüksek Sıcaklığa Dayanımlı Ni-Cd Pil Grubu |
| Elektrik Sınıfı | 5°C / 45°C |
| Uygunluk | I |
| | EN 60598-2-22 |

| | |
|---------------------------|---|
| Product Description | Emergency Lighting |
| Body | Injection Acrylic Plexiglass in ABS Extrusion Body |
| Working Voltage | Standard Pressed or Sticker With Pictogram Shape |
| Charge Duration | 220 - 230 V AC 50/60Hz ±%10 |
| Battery Capacity | 24h |
| Colour Temperature | 1.2V 1.1Ah |
| Battery | 6500K |
| Operating Temperature | High Temperature Ni-Cd Batteries |
| Electrical Classification | 5°C / 45°C |
| Conformity | I |
| | EN 60598-2-22 |



150x325x45mm

| Açıklama | Ürün Görseli |
|----------------------------|--|
| Bayrak tipi montaj aparatı |  380gr |
| Askı zinciri |  |
| Sıva altı aparatı |  |

2x1000mm

330x80x50mm

Montaj Seçenekleri

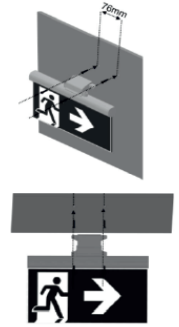
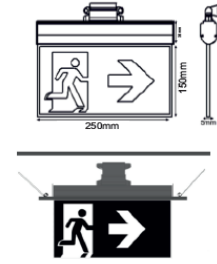

| Ürün Kodu Product Code | Güç Power | Çıkış Işık Akısı Lumen Output | Verimlilik Efficiency | Işık Açısı Beam Angle | Işık Kaynağı Light Source | CRI | L (mm) | W (mm) | H (mm) |
|---------------------------|--------------|----------------------------------|--------------------------|--------------------------|------------------------------|-----|-----------|-----------|-----------|
| 16033 | 2W | 90Lm | 45Lm/W | | LED | 80 | 250 | 150 | 55 |





Görülebilir Mesafesi : 30m
Visibility Range:30m

Acil Durumda 3 Saat Yanabilir
Emergency Operation Time 3 Hours

Çift yönlü, sivaüstü montaj
Surface Mounted, Double Sided

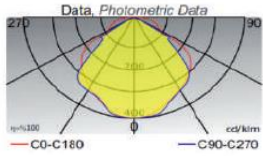

ÜRÜN ÖZELLİKLERİ/PRODUCT SPECIFICATIONS

| Ürün Tanımı | Acil Durum Yönlendirme Armatürleri | Product Description | Emergency Lighting |
|--------------------|--|---------------------------|---|
| Gövde | ABS Ekstrüzyon Gövde Enjeksiyon Akirlik Plexiglas | Body | Injection Acrylic Plexiglass in ABS Extrusion Body |
| Çalışma Gerilimi | Standart Şekillerde Serigrafi Baskılı Etiket | Working Voltage | Standard Pressed or Sticker With Pictogram Shape |
| Şarj Süresi | 220 - 230 V AC 50/60Hz ±%10 | Charge Duration | 220 - 230 V AC 50/60Hz ±%10 |
| Batarya Kapasitesi | 24h | Battery Capacity | 24h |
| Renk Sıcaklığı | 1.2V 1.1Ah | Colour Temperature | 1.2V 1.1Ah |
| Pil | 6500K | Battery | High Temperature Ni-Cd Batteries |
| Çalışma Sıcaklığı | Yüksek Sıcaklığa Dayanıklı Ni-Cd Pil Grubu | Operating Temperature | 5°C / 45°C |
| Elektrik Sınıfı | 5°C / 45°C | Electrical Classification | I |
| Uygunluk | I | Conformity | EN 60598-2-22 |

| Açıklama | Ürün Görseli |
|--|--|
| 150x325x45mm Bayrak tipi montaj aparatı |  380gr |
| 2x1000mm Askı zinciri |  |
| 377x80x50mm Sıva altı aparatı |  |

Montaj Seçenekleri

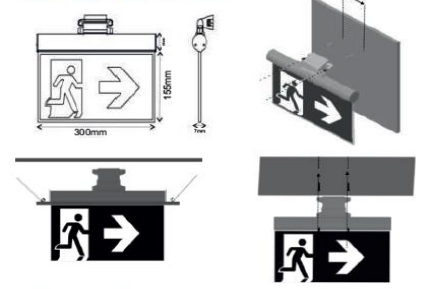

| Ürün Kodu Product Code | Güç Power | Çıkış Işık Akısı Lumen Output | Verimlilik Efficiency | Işık Açısı Beam Angle | Işık Kaynağı Light Source | CRI | L (mm) | W (mm) | H (mm) |
|---------------------------|--------------|----------------------------------|--------------------------|--------------------------|------------------------------|-----|-----------|-----------|-----------|
| 16034 | 2W | 90Lm | 45Lm/W | | LED | 80 | 300 | 155 | 70 |





Görülebilir Mesafesi : 30m
Visibility Range:30m

Acil Durumda 3 Saat Yanabilir
Emergency Operation Time 3 Hours

Çift yönlü, sivaüstü montaj
Surface Mounted, Double Sided

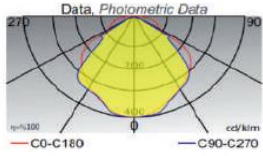

ÜRÜN ÖZELLİKLERİ/PRODUCT SPECIFICATIONS

| Ürün Tanımı | Acil Durum Yönlendirme Armatürleri | Product Description | Emergency Lighting |
|--------------------|--|---------------------------|---|
| Gövde | ABS Ekstrüzyon Gövde Enjeksiyon Akirlik Plexiglas | Body | Injection Acrylic Plexiglass in ABS Extrusion Body |
| Çalışma Gerilimi | Standart Şekillerde Serigrafi Baskılı Etiket | Working Voltage | Standard Pressed or Sticker With Pictogram Shape |
| Şarj Süresi | 220 - 230 V AC 50/60Hz ±%10 | Charge Duration | 220 - 230 V AC 50/60Hz ±%10 |
| Batarya Kapasitesi | 24h | Battery Capacity | 24h |
| Renk Sıcaklığı | 1.2V 1v1Ah & 3.7V 2Ah | Battery Capacity | 1.2V 1v1Ah & 3.7V 2Ah |
| Pil | 6500K | Colour Temperature | 6500K |
| Çalışma Sıcaklığı | Yüksek Sıcaklığa Dayanıklı Ni-Cd Pil Grubu | Battery | High Temperature Ni-Cd Batteries |
| Elektrik Sınıfı | 5°C / 45°C | Operating Temperature | 5°C / 45°C |
| Uygunluk | I | Electrical Classification | I |
| | EN 60598-2-22 | Conformity | EN 60598-2-22 |

150x325x45mm

2x1000mm

377x80x50mm

| Açıklama | Ürün Görseli |
|----------------------------|---|
| Bayrak tipi montaj aparatı |  380gr |
| Askı zinciri |  |
| Sıva altı aparatı |  |

Montaj Seçenekleri

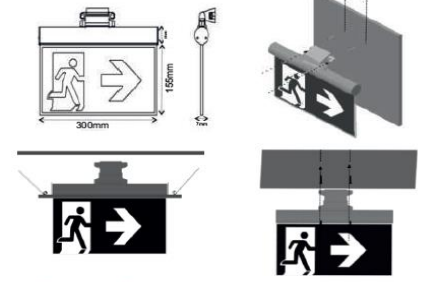

| Ürün Kodu Product Code | Güç Power | Çıkış Işık Akısı Lumen Output | Verimlilik Efficiency | Işık Açısı Beam Angle | Işık Kaynağı Light Source | CRI | L (mm) | W (mm) | H (mm) |
|---------------------------|--------------|----------------------------------|--------------------------|--------------------------|------------------------------|-----|-----------|-----------|-----------|
| 16035 | 2W | 90Lm | 45Lm/W | | LED | 80 | 300 | 155 | 70 |
| 16036 | 5W | 330Lm | 66Lm/W | | LED | 80 | 300 | 155 | 70 |





Görülebilir Mesafesi : 30m
Visibility Range:30m

Acil Durumda 3 Saat Yanabilir
Emergency Operation Time 3 Hours

Çift yüzlü, sivaüstü montaj
Surface Mounted, Double Sided

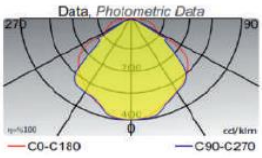

ÜRÜN ÖZELLİKLERİ/PRODUCT SPECIFICATIONS

| | |
|--------------------|--|
| Ürün Tanımı | Acil Durum Yönlendirme Armatürleri |
| Gövde | ABS Ekstrüzyon Gövde Enjeksiyon Akrilik Plexiglas Standart Şekillerde Serigrafi Baskılı Etiket |
| Çalışma Gerilimi | 220 - 230 V AC 50/60Hz ±%10 |
| Şarj Süresi | 24h |
| Batarya Kapasitesi | 1.2V 1v1Ah & 3.7V 2Ah |
| Renk Sıcaklığı | 6500K |
| Pil | Yüksek Sıcaklığa Dayanımlı Ni-Cd Pil Grubu |
| Çalışma Sıcaklığı | 5°C / 45°C |
| Elektrik Sınıfı | II |
| Uygunluk | EN 60598-2-22 |

| | |
|---------------------------|--|
| Product Descripton | Emergency Lighting |
| Body | Injection Acrylic Plexiglass in ABS Extrusion Body Standard Pressed or Sticker With Pictogram Shape |
| Working Voltage | 220 - 230 V AC 50/60Hz ±%10 |
| Charge Duration | 24h |
| Battery Capacity | 1.2V 1v1Ah & 3.7V 2Ah |
| Colour Temperature | 6500K |
| Battery | High Temperature Ni-Cd Batteries |
| Operating Temperature | 5°C / 45°C |
| Electrical Classification | II |
| Conformity | EN 60598-2-22 |

| Açıklama | Ürün Görseli |
|--------------|-------------------------------------|
| 150x325x45mm | Bayrak tipi montaj aparatı 380gr |
| 2x1000mm | Çelik Askı Teli |

Montaj Seçenekleri

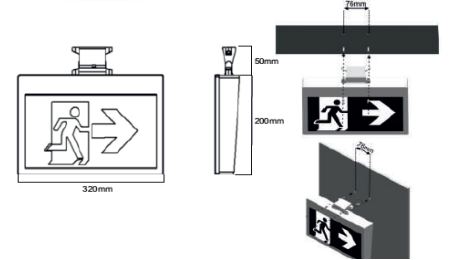

| Ürün Kodu Product Code | Güç Power | Çıkış Işık Akısı Lumen Output | Verimlilik Efficiency | Işık Açısı Beam Angle | Işık Kaynağı Light Source | CRI | L (mm) | W (mm) | H (mm) |
|---------------------------|--------------|----------------------------------|--------------------------|--------------------------|------------------------------|-----|-----------|-----------|-----------|
| 16037 | 2W | 90Lm | 45Lm/W | | LED | 80 | 320 | 200 | 50 |
| 16038 | 5W | 330Lm | 66Lm/W | | LED | 80 | 300 | 200 | 50 |





Görülebilir Mesafesi : 30m
Visibility Range:30m

Acil Durumda 3 Saat Yanabilir
Emergency Operation Time 3 Hours

Çift yönlü, sivaüstü montaj
Surface Mounted, Double Sided

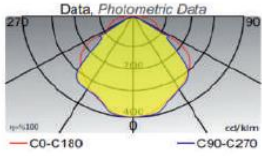

ÜRÜN ÖZELLİKLERİ/PRODUCT SPECIFICATIONS

| Ürün Tanımı | Acil Durum Yönlendirme Armatürleri | Product Description | Emergency Lighting |
|--------------------|--|---------------------------|---|
| Gövde | ABS Ekstrüzyon Gövde Enjeksiyon Akirlik Plexiglas | Body | Injection Acrylic Plexiglass in ABS Extrusion Body |
| Çalışma Gerilimi | Standart Şekillerde Serigrafi Baskılı Etiket | Working Voltage | Standard Pressed or Sticker With Pictogram Shape |
| Şarj Süresi | 220 - 230 V AC 50/60Hz ±%10 | Charge Duration | 220 - 230 V AC 50/60Hz ±%10 |
| Batarya Kapasitesi | 24h | Battery Capacity | 24h |
| Renk Sıcaklığı | 1.2V 1v1Ah & 3.7V 2Ah | Colour Temperature | 1.2V 1v1Ah & 3.7V 2Ah |
| Pil | 6500K | Battery | High Temperature Ni-Cd Batteries |
| Çalışma Sıcaklığı | Yüksek Sıcaklığa Dayanıklı Ni-Cd Pil Grubu | Operating Temperature | 5°C / 45°C |
| Elektrik Sınıfı | 5°C / 45°C | Electrical Classification | II |
| Uygunluk | II | Conformity | EN 60598-2-22 |

| Açıklama | Ürün Görseli |
|---------------------------------------|---|
| 170x40mm Asma Tavan Montaj Yayı |  |
| 70x20mm 80gr Kablo Tavasına Montaj |  |

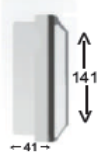
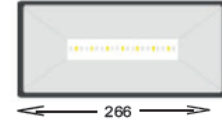

Montaj Seçenekleri



| Ürün Kodu Product Code | Güç Power | Çıkış Işık Akısı Lumen Output | Verimlilik Efficiency | Işık Açısı Beam Angle | Işık Kaynağı Light Source | CRI | L (mm) | W (mm) | H (mm) |
|---------------------------|--------------|----------------------------------|--------------------------|--------------------------|------------------------------|-----|-----------|-----------|-----------|
| 16039 | 2W | 90Lm | 45Lm/W | | LED | 80 | 266 | 41 | 141 |
| 16040 | 5W | 330Lm | 66Lm/W | | LED | 80 | 266 | 41 | 141 |





Görülebilir Mesafesi : 30m
Visibility Range:30m

Acil Durumda 3 Saat Yanabilme
Emergency Operation Time 3 Hours

Sıva Üstü Montaj
Surface Mounted

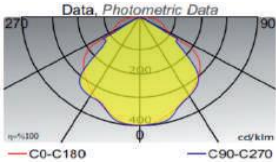

ÜRÜN ÖZELLİKLERİ/PRODUCT SPECIFICATIONS

| Ürün Tanımı | Acil Durum Yönlendirme Armatürleri | Product Description | Emergency Lighting |
|--------------------|--|---------------------------|--|
| Gövde | Polikarbon Gövde Opal Kapak | Body | Polycarbonate Body Opal Cover |
| | Standart Şekillerde Serigrafi Baskılı Etiket | | Standard Pressed or Sticker With Pictogram Shape |
| Çalışma Gerilimi | 220 - 230 V AC 50/60Hz ±%10 | Working Voltage | 220 - 230 V AC 50/60Hz ±%10 |
| Şarj Süresi | 24h | Charge Duration | 24h |
| Batarya Kapasitesi | 1.2V 1v1Ah & 3.7V 2Ah | Battery Capacity | 1.2V 1v1Ah & 3.7V 2Ah |
| Renk Sıcaklığı | 6500K | Colour Temperature | 6500K |
| Pil | Yüksek Sıcaklığa Dayanıklı Ni-Cd Pil Grubu | Battery | High Temperature Ni-Cd Batteries |
| Çalışma Sıcaklığı | 5°C / 45°C | Operating Temperature | 5°C / 45°C |
| Elektrik Sınıfı | I | Electrical Classification | I |
| Uygunluk | EN 60598-2-22 | Conformity | EN 60598-2-22 |

Montaj Seçenekleri

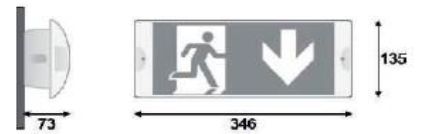

| Ürün Kodu Product Code | Güç Power | Çıkış Işık Akısı Lumen Output | Verimlilik Efficiency | Işık Açısı Beam Angle | Işık Kaynağı Light Source | CRI | L (mm) | W (mm) | H (mm) |
|---------------------------|--------------|----------------------------------|--------------------------|--------------------------|------------------------------|-----|-----------|-----------|-----------|
| 16041 | 2W | 90Lm | 45Lm/W | | LED | 80 | 346 | 73 | 135 |
| 16042 | 5W | 330Lm | 66Lm/W | | LED | 80 | 346 | 73 | 135 |





Görülebilir Mesafesi : 30m
Visibility Range:30m

Acil Durumda 3 Saat Yanabilir
Emergency Operation Time 3 Hours

Sıva Üstü Montaj
Surface Mounted

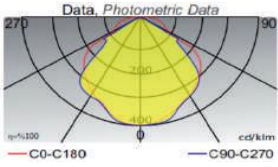

ÜRÜN ÖZELLİKLERİ/PRODUCT SPECIFICATIONS

| Ürün Tanımı | Acil Durum Yönlendirme Armatürleri | Product Description | Emergency Lighting |
|---------------------------|--|----------------------------------|---|
| Gövde | Polikarbon Gövde Opal Kapak | Body | Polycarbonate Body Opal Cover |
| Çalışma Gerilimi | Standart Şekillerde Serigrafi Baskılı Etiket | Working Voltage | Standard Pressed or Sticker With Pictogram Shape |
| Şarj Süresi | 220 - 230 V AC 50/60Hz ±%10 | Charge Duration | 220 - 230 V AC 50/60Hz ±%10 |
| Batarya Kapasitesi | 24h | Battery Capacity | 24h |
| Renk Sıcaklığı | 1.2V 1v1Ah & 3.7V 2Ah | Colour Temperature | 1.2V 1v1Ah & 3.7V 2Ah |
| Pil | 6500K | Battery | High Temperature Ni-Cd Batteries |
| Çalışma Sıcaklığı | Yüksek Sıcaklığa Dayanıklı Ni-Cd Pil Grubu | Operating Temperature | 5°C / 45°C |
| Elektrik Sınıfı | 5°C / 45°C | Electrical Classification | I |
| Uygunluk | I | Conformity | EN 60598-2-22 |

Montaj Seçenekleri

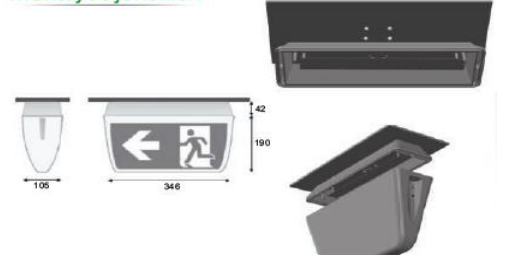

| Ürün Kodu Product Code | Güç Power | Çıkış Işık Akısı Lumen Output | Verimlilik Efficiency | Işık Açısı Beam Angle | Işık Kaynağı Light Source | CRI | L (mm) | W (mm) | H (mm) |
|---------------------------|--------------|----------------------------------|--------------------------|--------------------------|------------------------------|-----|-----------|-----------|-----------|
| 16043 | 2W | 90Lm | 45Lm/W | | LED | 80 | 346 | 232 | 105 |
| 16044 | 5W | 330Lm | 66Lm/W | | LED | 80 | 346 | 232 | 105 |





Görülebilir Mesafesi : 30m
Visibility Range:30m

Acil Durumda 3 Saat Yanabilir
Emergency Operation Time 3 Hours

Sıva Üstü montaj
Surface Mounted

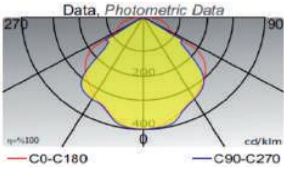

ÜRÜN ÖZELLİKLERİ/PRODUCT SPECIFICATIONS

| Ürün Tanımı | Acil Durum Yönlendirme Armatürleri | Product Description | Emergency Lighting |
|--------------------|---|---------------------------|---|
| Gövde | ABS Ekstrüzyon Gövde Enjeksiyon Akriklik Plexiglas | Body | Injection Acrylic Plexiglass in ABS Extrusion Body |
| Çalışma Gerilimi | Standart Şekillerde Serigrafi Baskılı Etiket | Working Voltage | Standard Pressed or Sticker With Pictogram Shape |
| Şarj Süresi | 220 - 230 V AC 50/60Hz ±%10 | Charge Duration | 220 - 230 V AC 50/60Hz ±%10 |
| Batarya Kapasitesi | 24h | Battery Capacity | 24h |
| Renk Sıcaklığı | 1.2V 1v1Ah & 3.7V 2Ah | Battery Capacity | 1.2V 1v1Ah & 3.7V 2Ah |
| Pil | 6500K | Colour Temperature | 6500K |
| Çalışma Sıcaklığı | Yüksek Sıcaklığa Dayanıklı Ni-Cd Pil Grubu | Battery | High Temperature Ni-Cd Batteries |
| Elektrik Sınıfı | 5°C / 45°C | Operating Temperature | 5°C / 45°C |
| Uygunluk | I | Electrical Classification | I |
| | EN 60598-2-22 | Conformity | EN 60598-2-22 |

Montaj Seçenekleri

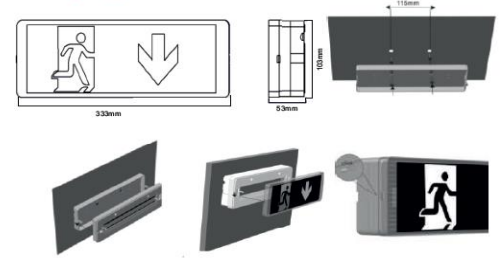

| Ürün Kodu Product Code | Güç Power | Çıkış Işık Akısı Lumen Output | Verimlilik Efficiency | Işık Açısı Beam Angle | Işık Kaynağı Light Source | CRI | L (mm) | W (mm) | H (mm) |
|---------------------------|--------------|----------------------------------|--------------------------|--------------------------|------------------------------|-----|-----------|-----------|-----------|
| 16045 | 2W | 90Lm | 45Lm/W | | LED | 80 | 333 | 53 | 105 |
| 16046 | 5W | 330Lm | 66Lm/W | | LED | 80 | 333 | 53 | 105 |





Görülebilir Mesafesi : 30m
Visibility Range:30m

Acil Durumda 3 Saat Yanabilir
Emergency Operation Time 3 Hours

Sıva Üstü Montaj
Surface Mounted

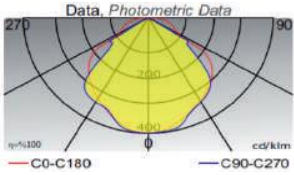

ÜRÜN ÖZELLİKLERİ/PRODUCT SPECIFICATIONS

| Ürün Tanımı | Acil Durum Yönlendirme Armatürleri | Product Descripton | Emergency Lighting |
|--------------------|--|---------------------------|--|
| Gövde | Saç Konstrüksiyon Üzeri Opal Plexiglas | Body | Over The Sheet Construction Opal Plexiglass |
| Çalışma Gerilimi | Standart Şekillerde Serigrafi Baskılı Etiket | Working Voltage | Standard Pressed or Sticker With Pictogram Shape |
| Şarj Süresi | 220 - 230 V AC 50/60Hz ±%10 | Charge Duration | 220 - 230 V AC 50/60Hz ±%10 |
| Batarya Kapasitesi | 24h | Battery Capacity | 24h |
| Renk Sıcaklığı | 1.2V 1v1Ah & 3.7V 2Ah | Colour Temperature | 1.2V 1v1Ah & 3.7V 2Ah |
| Pil | 6500K | Battery | High Temperature Ni-Cd Batteries |
| Çalışma Sıcaklığı | Yüksek Sıcaklığa Dayanıklı Ni-Cd Pil Grubu | Operating Temperature | 5°C / 45°C |
| Elektrik Sınıfı | 5°C / 45°C | Electrical Classification | I |
| Uygunluk | I | Conformity | EN 60598-2-22 |

| Açıklama | Ürün Görseli |
|--------------|-------------------------------------|
| 150x325x45mm | Bayrak tipi montaj aparatı 380gr |
| 2x1000mm | Çelik Askı Teli |

Montaj Seçenekleri

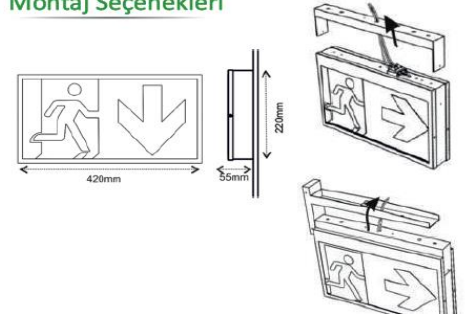

| Ürün Kodu Product Code | Güç Power | Çıkış Işık Akısı Lumen Output | Verimlilik Efficiency | Işık Açısı Beam Angle | Işık Kaynağı Light Source | CRI | L (mm) | W (mm) | H (mm) |
|---------------------------|--------------|----------------------------------|--------------------------|--------------------------|------------------------------|-----|-----------|-----------|-----------|
| 16047 | 2W | 90Lm | 45Lm/W | | LED | 80 | 420 | 220 | 55 |
| 16048 | 5W | 330Lm | 66Lm/W | | LED | 80 | 420 | 220 | 55 |





Görülebilir Mesafesi : 30m
Visibility Range:30m

Acil Durumda 3 Saat Yanabilir
Emergency Operation Time 3 Hours

Çift yönlü, sivaüstü montaj
Surface Mounted, Double Sided

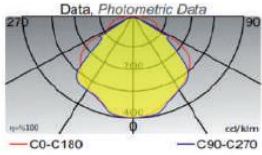

ÜRÜN ÖZELLİKLERİ/PRODUCT SPECIFICATIONS

| | |
|---------------------------|--|
| Ürün Tanımı | Acil Durum Yönlendirme Armatürleri |
| Gövde | Saç Konstrüksiyon Üzeri Opal Plexiglas |
| | Standart Şekillerde Serigrafi Baskılı Etiket |
| Çalışma Gerilimi | 220 - 230 V AC 50/60Hz ±%10 |
| Şarj Süresi | 24h |
| Batarya Kapasitesi | 1.2V 1v1Ah & 3.7V 2Ah |
| Renk Sıcaklığı | 6500K |
| Pil | Yüksek Sıcaklığa Dayanımlı Ni-Cd Pil Grubu |
| Çalışma Sıcaklığı | 5°C / 45°C |
| Elektrik Sınıfı | I |
| Uygunluk | EN 60598-2-22 |

| | |
|----------------------------------|--|
| Product Descripton | Emergency Lighting |
| Body | Over The Sheet Construction Opal Plexiglass |
| | Standard Pressed or Sticker With Pictogram Shape |
| Working Voltage | 220 - 230 V AC 50/60Hz ±%10 |
| Charge Duration | 24h |
| Battery Capacity | 1.2V 1v1Ah & 3.7V 2Ah |
| Colour Temperature | 6500K |
| Battery | High Temperature Ni-Cd Batteries |
| Operating Temperature | 5°C / 45°C |
| Electrical Classification | I |
| Conformity | EN 60598-2-22 |

150x325x45mm

2x1000mm

| Açıklama | Ürün Görseli |
|----------------------------|---|
| Bayrak tipi montaj aparatı |  380gr |
| Çelik Askı Teli |  |

Montaj Seçenekleri

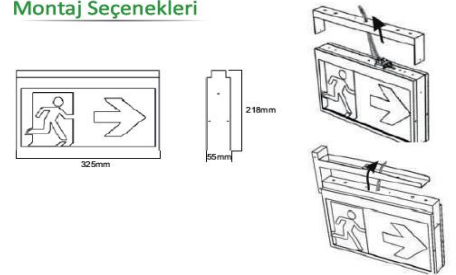

| Ürün Kodu Product Code | Güç Power | Çıkış Işık Akısı Lumen Output | Verimlilik Efficiency | Işık Açısı Beam Angle | Işık Kaynağı Light Source | CRI | L (mm) | W (mm) | H (mm) |
|---------------------------|--------------|----------------------------------|--------------------------|--------------------------|------------------------------|-----|-----------|-----------|-----------|
| 16049 | 2W | 90Lm | 45Lm/W | | LED | 80 | 325 | 180 | 55 |
| 16050 | 5W | 330Lm | 66Lm/W | | LED | 80 | 325 | 180 | 55 |





Acil Durumda 3 Saat Yanabilme
Emergency Operation Time 3 Hours

Open Area Lens

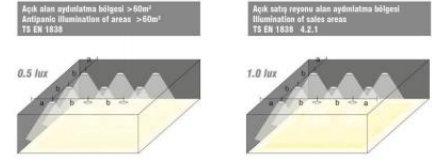
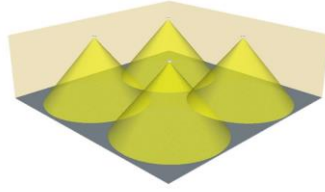
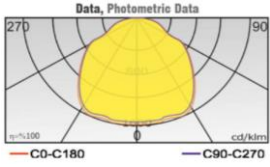

ÜRÜN ÖZELLİKLERİ/PRODUCT SPECIFICATIONS

| | |
|--------------------|--|
| Ürün Tanımı | Acil Durum Aydınlatması |
| Gövde | UV Özellikli Termoplastik ABS Gövde Optimum Sıcaklığı Sağlayan Geniş Soğutucu Yüzeyle Enjeksiyon Alüminyum |
| Çalışma Gerilimi | 220 - 230 V AC 50/60Hz ±%10 |
| Şarj Süresi | 24h |
| Batarya Kapasitesi | 3.7V 2Ah |
| Renk Sıcaklığı | 6500K |
| Pil | Yüksek Performans Lithium Ion Pil |
| Çalışma Sıcaklığı | -.5°C / 45°C |
| Süre | 3 Saat |
| Ral Kodu | 9016 Beyaz |
| Elektrik Sınıfı | II |
| Uygunluk | EN 60598-2-22 |

| | |
|---------------------------|---|
| Product Descripton | Emergency Lighting |
| Body | UV-Featured ABS Thermoplas Large Heat Sink Ensures Optimum Thermal Management |
| Working Voltage | 220 - 230 V AC 50/60Hz ±%10 |
| Charge Duration | 24h |
| Battery Capacity | 3.7V 2Ah |
| Colour Temperature | 6500K |
| Battery | High Perform Lithium Ion Battery |
| Operating Temperature | -.5°C / 45°C |
| Duration | 3 hour |
| Ral Code | 9016 White |
| Electrical Classification | II |
| Conformity | EN 60598-2-22 |

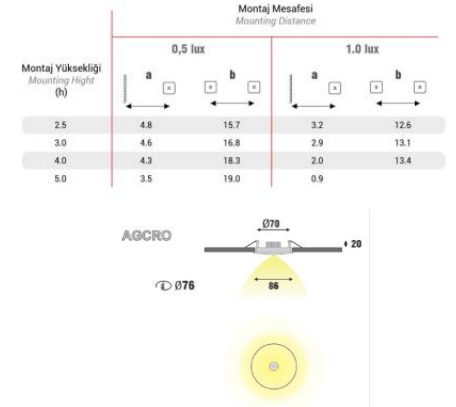

| Ürün Kodu Product Code | Güç Power | Çıkış Işık Akısı Lumen Output | Verimlilik Efficiency | Işık Açısı Beam Angle | Işık Kaynağı Light Source | CRI | Ø (mm) | ØCUT (mm) | H (mm) |
|---------------------------|--------------|----------------------------------|--------------------------|--------------------------|------------------------------|-----|-----------|--------------|-----------|
| 47006 | 3W | 240Lm | 80Lm/W | Açık Alan | LED | 80 | 120 | 76 | 40 |





Acil Durumda 3 Saat Yanabilme
Emergency Operation Time 3 Hours

Escape Route Lens

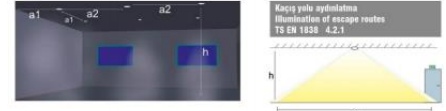
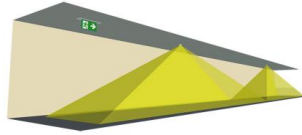
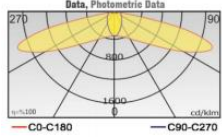

ÜRÜN ÖZELLİKLERİ/PRODUCT SPECIFICATIONS

| | |
|--------------------|--|
| Ürün Tanımı | Acil Durum Aydınlatması |
| Gövde | UV Özellikli Termoplastik ABS Gövde Optimum Sıcaklığı Sağlayan Geniş Soğutucu Yüzeyle Enjeksiyon Alüminyum |
| Çalışma Gerilimi | 220 - 230 V AC 50/60Hz ±%10 |
| Şarj Süresi | 24h |
| Batarya Kapasitesi | 3.7V 2Ah |
| Renk Sıcaklığı | 6500K |
| Pil | Yüksek Performans Lithium İyon Pil |
| Çalışma Sıcaklığı | 5°C / 45°C |
| Süre | 3 Saat |
| Ral Kodu | 9016 Beyaz |
| Elektrik Sınıfı | II |
| Uygunluk | EN 60598-2-22 |

| | |
|---------------------------|---|
| Product Descripton | Emergency Lighting |
| Body | UV-Featured ABS Thermoplas Large Heat Sink Ensures Optimum Thermal Management |
| Working Voltage | 220 - 230 V AC 50/60Hz ±%10 |
| Charge Duration | 24h |
| Battery Capacity | 3.7V 2Ah |
| Colour Temperature | 6500K |
| Battery | High Perform Lithium Ion Battery |
| Operating Temperature | 5°C / 45°C |
| Duration | 3 hour |
| Ral Code | 9016 White |
| Electrical Classification | II |
| Conformity | EN 60598-2-22 |

| | | | |
|---|---|------|------|
| Montaj Yüksekliği Mounting Height (h) | Montaj Mesafesi Mounting Distance 1.0 lux | | |
| | a1 | a2 | a |
| | 2.5 | 10.1 | 24.1 |
| | 3.0 | 10.9 | 26.4 |
| | 4.0 | 12.0 | 30.0 |
| 5.0 | 12.3 | 32.7 | |
| | | | 20.0 |
| | | | 23.2 |
| | | | 26.3 |
| | | | 28.4 |

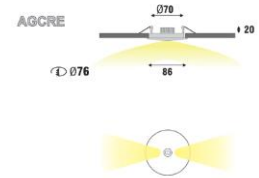

| Ürün Kodu Product Code | Güç Power | Çıkış Işık Akısı Lumen Output | Verimlilik Efficiency | Işık Açısı Beam Angle | Işık Kaynağı Light Source | CRI | Ø (mm) | ØCUT (mm) | H (mm) |
|---------------------------|--------------|----------------------------------|--------------------------|--------------------------|------------------------------|-----|-----------|--------------|-----------|
| 47007 | 3W | 240Lm | 80Lm/W | Kaçış Yolu | LED | 80 | 120 | 76 | 40 |





Acil Durumda 3 Saat Yanabilme
Emergency Operation Time 3 Hours

Open Area Lens

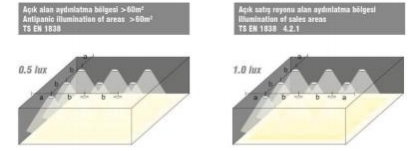
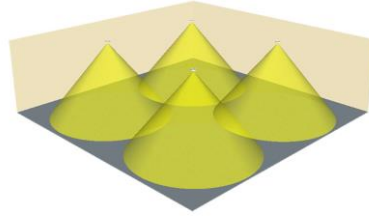
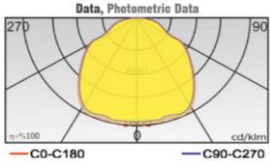

ÜRÜN ÖZELLİKLERİ/PRODUCT SPECIFICATIONS

| | |
|---------------------------|---|
| Ürün Tanımı | Acil Durum Aydınlatması |
| Gövde | UV Özellikli Termoplastik ABS Gövde Optimum Sıcaklığı Sağlayan Geniş Soğutucu Yüze Yli Enjeksiyon Alüminyum |
| Çalışma Gerilimi | 220 - 230 V AC 50/60Hz ±%10 |
| Şarj Süresi | 24h |
| Batarya Kapasitesi | 3.7V 2Ah |
| Renk Sıcaklığı | 6500K |
| Pil | Yüksek Performans Lithium Ion Pil |
| Çalışma Sıcaklığı | 5°C / 45°C |
| Süre | 3 Saat |
| Ral Kodu | 9016 Beyaz |
| Elektrik Sınıfı | II |
| Uygunluk | EN 60598-2-22 |

| | |
|----------------------------------|---|
| Product Description | Emergency Lighting |
| Body | UV-Featured ABS Thermoplas Large Heat Sink Ensures Optimum Thermal Management |
| Working Voltage | 220 - 230 V AC 50/60Hz ±%10 |
| Charge Duration | 24h |
| Battery Capacity | 3.7V 2Ah |
| Colour Temperature | 6500K |
| Battery | High Perform Lithium Ion Battery |
| Operating Temperature | 5°C / 45°C |
| Duration | 3 hour |
| Ral Code | 9016 White |
| Electrical Classification | II |
| Conformity | EN 60598-2-22 |

| Montaj Yüksekliği Mounting Height (h) | 0,5 lux | | 1,0 lux | |
|---|---------|------|---------|------|
| | a | b | a | b |
| 2.5 | 4.8 | 15.7 | 3.2 | 12.6 |
| 3.0 | 4.6 | 16.8 | 2.9 | 13.1 |
| 4.0 | 4.3 | 18.3 | 2.0 | 13.4 |
| 5.0 | 3.5 | 19.0 | 0.9 | |

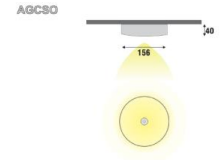

| Ürün Kodu Product Code | Güç Power | Çıkış Işık Akısı Lumen Output | Verimlilik Efficiency | Işık Açısı Beam Angle | Işık Kaynağı Light Source | CRI | L (mm) | W (mm) | H (mm) |
|---------------------------|--------------|----------------------------------|--------------------------|--------------------------|------------------------------|-----|-----------|-----------|-----------|
| 47008 | 3W | 240Lm | 80Lm/W | Açık Alan | LED | 80 | 145 | 145 | 40 |





Acil Durumda 3 Saat Yanabilme
Emergency Operation Time 3 Hours

Escape Route Lens

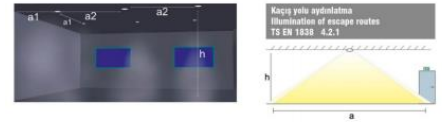
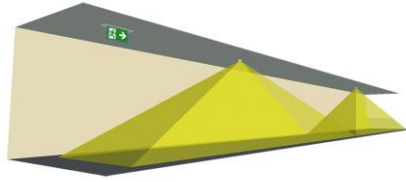
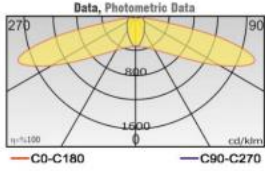

ÜRÜN ÖZELLİKLERİ/PRODUCT SPECIFICATIONS

| | |
|---------------------------|--|
| Ürün Tanımı | Acil Durum Aydınlatması |
| Gövde | UV Özellikli Termoplastik ABS Gövde Optimum Sıcaklığı Sağlayan Geniş Soğutucu Yüzeyle Enjeksiyon Alüminyum |
| Çalışma Gerilimi | 220 - 230 V AC 50/60Hz ±%10 |
| Şarj Süresi | 24h |
| Batarya Kapasitesi | 3.7V 2Ah |
| Renk Sıcaklığı | 6500K |
| Pil | Yüksek Performans Lithium Ion Pil |
| Çalışma Sıcaklığı | 5°C / 45°C |
| Süre | 3 Saat |
| Ral Kodu | 9016 Beyaz |
| Elektrik Sınıfı | II |
| Uygunluk | EN 60598-2-22 |

| | |
|----------------------------------|---|
| Product Descripton | Emergency Lighting |
| Body | UV-Featured ABS Thermoplas Large Heat Sink Ensures Optimum Thermal Management |
| Working Voltage | 220 - 230 V AC 50/60Hz ±%10 |
| Charge Duration | 24h |
| Battery Capacity | 3.7V 2Ah |
| Colour Temperature | 6500K |
| Battery | High Perform Lithium Ion Battery |
| Operating Temperature | 5°C / 45°C |
| Duration | 3 hour |
| Ral Code | 9016 White |
| Electrical Classification | II |
| Conformity | EN 60598-2-22 |

| | | | |
|---|---|------|------|
| Montaj Yüksekliği Mounting Height (h) | Montaj Mesafesi Mounting Distance 1.0 lux | | |
| | a1 | a2 | a |
| | 2.5 | 10.1 | 24.1 |
| | 3.0 | 10.9 | 26.4 |
| | 4.0 | 12.0 | 30.0 |
| 5.0 | 12.3 | 32.7 | |

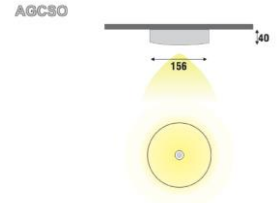

| Ürün Kodu Product Code | Güç Power | Çıkış Işık Akısı Lumen Output | Verimlilik Efficiency | Işık Açısı Beam Angle | Işık Kaynağı Light Source | CRI | L (mm) | W (mm) | H (mm) |
|---------------------------|--------------|----------------------------------|--------------------------|--------------------------|------------------------------|-----|-----------|-----------|-----------|
| 47009 | 3W | 240Lm | 80Lm/W | Kaçış Yolu | LED | 80 | 145 | 145 | 40 |



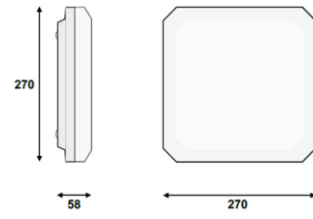
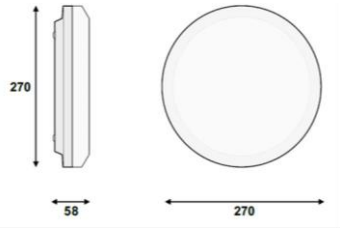
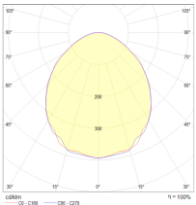

ÜRÜN ÖZELLİKLERİ/PRODUCT SPECIFICATIONS

| Ürün Tanımı | Sensörlü Ledli Kitli Acil Aydınlatma Armatürü | Product Description | Led Kit with Sensor Emergency Lighting |
|-------------------|---|-----------------------|---|
| Gövde | Termoplastik PC | Body | Thermoplastic PC |
| Pil | Yüksek Sıcaklığa Dayanıklı Nickel Cadmium / Lityum Ion | Battery | High Temperature Nickel Cadmium / Li-Ion |
| Difüzör | Opal PMMA | Diffuser | Opal PMMA |
| SDCM (MacAdam) | 3 | SDCM (MacAdam) | 3 |
| Renk Sıcaklığı | 3000K/6500K | Colour Temperature | 3000K/6500K |
| Ömür | 50000h | Life Time | 50000h |
| Çalışma Sıcaklığı | 25°C | Operating Temperature | 25°C |
| LED | Osram/Seoul | LED | Osram/Seoul |
| Uygunluk | EN60598-2-22 EN55014 EN60669-2-1 | Conformity | EN60598-2-22 EN55014 EN60669-2-1 |

| Ürün Kodu Product Code | Güç Power | Çıkış Işık Akısı Lumen Output | Verimlilik Efficiency | Işık Açısı Beam Angle | Işık Kaynağı Light Source | CRI | Ø (mm) | W (mm) | H (mm) |
|---------------------------|--------------|----------------------------------|--------------------------|--------------------------|------------------------------|-----|-----------|-----------|-----------|
| 9057 | 10W | 1000Lm/90Lm | 100Lm/W | 180°/360° | LED | 80 | 270 | 270 | 58 |
| 9058 | 26W | 2500Lm/330Lm | 96Lm/W | 180°/360° | LED | 80 | 270 | 270 | 58 |



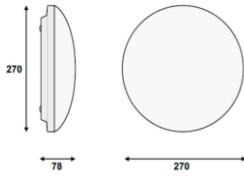
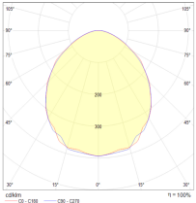

ÜRÜN ÖZELLİKLERİ/PRODUCT SPECIFICATIONS

| | | | |
|--------------------------|---|------------------------------|---|
| Ürün Tanımı | Sensörlü Ledli Kitli Acil Aydınlatma Armatürü | Product Description | Led Kit with Sensor Emergency Lighting |
| Gövde | Termoplastik PC | Body | Thermoplastic PC |
| Pil | Yüksek Sıcaklığa Dayanıklı Nickel Cadmium / Lityum Ion | Battery | High Temperature Nickel Cadmium / Li-Ion |
| Difüzör | Opal PMMA | Diffuser | Opal PMMA |
| SDCM (MacAdam) | 3 | SDCM (MacAdam) | 3 |
| Renk Sıcaklığı | 3000K/6500K | Colour Temperature | 3000K/6500K |
| Ömür | 50000h | Life Time | 50000h |
| Çalışma Sıcaklığı | 25°C | Operating Temperature | 25°C |
| LED | Osram/Seoul | LED | Osram/Seoul |
| Uygunluk | EN60598-2-22 EN55014 EN60669-2-1 | Conformity | EN60598-2-22 EN55014 EN60669-2-1 |

| Ürün Kodu Product Code | Güç Power | Çıkış Işık Akısı Lumen Output | Verimlilik Efficiency | Işık Açısı Beam Angle | Işık Kaynağı Light Source | CRI | Ø (mm) | W (mm) | H (mm) |
|---------------------------|--------------|----------------------------------|--------------------------|--------------------------|------------------------------|-----|-----------|-----------|-----------|
| 9087 | 10W | 1000Lm/90Lm | 100Lm/W | 180°/360° | LED | 80 | 270 | 270 | 78 |
| 9088 | 26W | 2500Lm/330Lm | 96Lm/W | 180°/360° | LED | 80 | 270 | 270 | 78 |



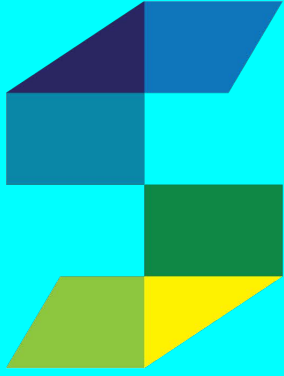

SOHO

Light Design

iSTANBUL MERKEZ OFİS:
Ferhatpaşa Mahallesi Üsküdar Caddesi
Coşkun İş Merkezi No:42/5
Ataşehir/İSTANBUL
Tel : +90 216 576 69 41
Fax: +90 216 576 69 42
info@soholight.com